

Robert Henry Thurston

A Gift to  
Cornell University Library

1903

A.186836.

11/2/05





## Cornell University Library

The original of this book is in  
the Cornell University Library.

There are no known copyright restrictions in  
the United States on the use of the text.





A TREATISE

ON

ORDNANCE

AND

NAVAL GUNNERY,

COMPILED AND ARRANGED

AS A

TEXT BOOK FOR THE U. S. NAVAL ACADEMY.

BY

LIEUT. EDWARD SIMPSON,

U. S. NAVY.

---

SECOND EDITION, REVISED AND ENLARGED.

---

NEW YORK :

D. VAN NOSTRAND, 192 BROADWAY,

1862.

D

VF  
145  
SGI  
1862

A. 186836

Entered according to Act of Congress, in the year 1861.

By D. VAN NOSTRAND,

In the Clerk's Office of the District Court of the United States, for the  
Southern District of New York.

VF

BUREAU OF ORDNANCE AND HYDROGRAPHY,

*July 9th, 1859.*

SIR :

The manuscript on Gunnery, compiled by Lieut. Edward Simpson, U. S. Navy, which was sent to this Bureau with your letter of the 15th ultimo, is herewith returned.

The Secretary of the Navy approves of the use of this work as a text book for the Academy. \* \* \* \* \*

Respectfully,

Your obd't serv't,

D. N. INGRAHAM,

*Chief of the Bureau.*

CAPTAIN G. S. BLAKE,  
*Superintendent of Naval Academy,*  
Annapolis, Md.



DEDICATION.

---

TO THE

HON. GEORGE BANCROFT,

TO WHOM

THE NAVY IS INDEBTED

FOR THE

UNITED STATES NAVAL ACADEMY,

THIS WORK

IS

RESPECTFULLY DEDICATED.



## PREFACE.

---

THIS work, originally designed merely as a text-book for the Naval Academy, has been allowed to depart from the essential character of such a work, in the hope that it might prove more acceptable to the Navy generally.

The compiler of this volume, when ordered to take charge of the instruction in Naval Gunnery at the Naval Academy, could find no single work that would cover the ground necessary for an elementary course in this branch. Many good works were at hand, but each bore on some speciality of the author, which it seemed to have been his object to set forth; no one volume was sufficiently comprehensive to supply the want; it became necessary to compile from each such parts as, when united, might embrace the whole subject. This volume is the result of the author's efforts to achieve this object.

In submitting his work to the Navy, the author desires to be understood as simply making an effort to circulate information which many officers, owing to constant service afloat, may not have been able to collect. This information he has endeavored to throw together in a readable and familiar form, and has avoided as much as possible all scientific demonstrations, making the work elementary in its character. He is well aware that, had this duty devolved on many of his brother officers, it would have been better executed; but, trusting to the generous character of the profession, he believes that his work will be generously dealt with.

The text is chiefly drawn from the writings of the following authors, viz.:

Sir HOWARD DOUGLAS, *Naval Gunnery*.

Captain J. H. WARD, U. S. N., *Ordnance and Gunnery*.

Major ALFRED MORDECAI, U. S. A., *Notes on Gunpowder*.

Captain MINER KNOWLTON, U. S. A., *Notes on Construction of Cannon, &c.*

Captain JOHN GIBBON, U. S. A., *Artillerist's Manual*.

Captain C. M. WILCOX, U. S. A., *Rifles and Rifle Practice*.

Lieutenant W. N. JEFFERS, U. S. N., *Theory and Practice of Naval Gunnery*.

Professor TREADWELL, *Cannon of Large Calibre*.

M. THIROUX, *Instruction d'Artillerie*.

Mr. W. C. E. GREENER, *Gunnery in 1858*.

Professor MAGNUS, *Deviation of Elongated Projectiles*.

Mr. J. M. B. SCOFFERN, *Projectile Weapons of War*.

Mr. LYNALL THOMAS, *Rifled Ordnance*.

M. PANOT.

Lieutenant STEVENS, R. N., *Pointing at Sea*.

M. PAGE, *Théorie du Pointage*.

Extracts have been made also from the following works, viz.:

*Ordnance Manual of the U. S. Army*.

*Ordnance Instructions of the U. S. Navy*.

*Aide-Mémoire to Military Sciences*.

"*Small Arms*" (*Reports of Experiments, Ordnance Department*).

The writings of Major J. G. BARNARD, Commander J. H. DAHLGREN, and Captain J. G. BENTON, U. S. Army, have also been consulted, and a few extracts made from the works of the last two authors.

E. SIMPSON,

Lieutenant U. S. Navy.

U. S. NAVAL ACADEMY,

NEWPORT, R. I., October 16, 1861. .

# CONTENTS.

---

## CHAPTER I.

	ART.
REVIEW OF ANCIENT ARMS .....	4
ANCIENT ENGINES OF WAR .....	9
ANCIENT MEN-OF-WAR .....	14
ANCIENT ARTILLERY .....	15
INVENTION OF GUNPOWDER AND ANCIENT CANNON, WITH ACCOUNT OF THEIR EARLIEST USES .....	16
ADVANCE IN GUN-MAKING, &C. ....	18
BATTLE OF LEPANTO .....	23
MORTAR .....	27
INTRODUCTION OF CARRONADES .....	29
RESUMÉ OF THE HISTORY OF CALIBRE .....	33
EXPERIENCE OF WAR OF 1812 .....	34
MAXIMUM CALIBRES NOW IN USE IN THE UNITED STATES NAVY .....	35

## CHAPTER II.

### FABRICATION OF CANNON.

CAST-IRON, WROUGHT-IRON, BRONZE .....	37
FABRICATION OF CANNON .....	56
BORING .....	68
CASTING ON A CORE ..	72
TURNING .....	73
VENT-PIECES .....	75
WEAKNESS OF WROUGHT-IRON CANNON .....	78
NOMENCLATURE OF CANNON .....	80
INSPECTION OF CANNON .....	81
PROOF OF CANNON .....	95
MARKING CANNON .....	99

## CHAPTER III.

### CANNON.

FORM OF CANNON .....	100
BOMFORD'S PLAN FOR DETERMINING FORM .....	100
RECOIL, EFFECT OF, ON CANNON AND SMALL ARMS .....	106
WINDAGE .....	110
PREPONDERANCE .....	115

	ART
PHENOMENA IN BORE ON COMBUSTION OF THE CHARGE .....	119
PROFESSOR TREADWELL ON LODGEMENTS .....	120
INCREASE OF STRAIN DUE TO INCREASE OF CALIBRE .....	122
INJURY TO BRONZE CANNON; DROOPING AT THE MUZZLE .....	124
INJURY TO CANNON IN PROOF .....	126
STRENGTHENING BANDS ON CANNON .....	131
MR. ROBERT MALLET ON PLANES OF WEAKNESS .....	132
PROFESSOR TREADWELL ON FRACTURES .....	133
EFFECT OF VIBRATION .....	140
EFFECT OF SHRINKING IN COOLING .....	142
CASTING ON A CORE, OR HOLLOW CASTING .....	143
EFFECT OF TRUNNIONS .....	145
EFFECT OF AGE ON ENDURANCE .....	147
TO RENDER CANNON UNSERVICEABLE .....	149
PRESERVATION OF CANNON .....	151

## CHAPTER IV.

## GUN-CARRIAGES.

CONDITIONS REQUIRED OF A GUN-CARRIAGE .....	152
FRICTION CARRIAGES .....	155
BREECHING. COMPOUND BREECHING .....	156
EFFECT OF HEIGHT OF CARRIAGE .....	159
IRON CARRIAGES .....	161
NAVY FOUR-TRUCK CARRIAGE .....	164
WARD'S GUN-CARRIAGE .....	173
MARSILLY (NAVY TWO-TRUCK) CARRIAGE .....	175
ROMME CARRIAGE .....	176
MARSHALL CARRIAGE .....	177
EHRESTHAM CARRIAGE .....	178
PIVOT CARRIAGES .....	179
VAN BRUNT'S CARRIAGE .....	182
BED AND QUOIN .....	186
ELEVATING SCREW .....	187
WARD'S SCREW-QUOIN .....	188
PORTER'S QUOIN .....	189
RULE FOR MOUNTING GUNS .....	190

## CHAPTER V.

## GUNPOWDER.

DISCOVERY OF GUNPOWDER .....	192
NITRE WALLS, BEDS .....	194
CHARCOAL .....	198
SULPHUR .....	201
MANUFACTURE OF GUNPOWDER .....	204
PACKING GUNPOWDER .....	213
PHENOMENA ATTENDING THE CHANGE FROM A SOLID TO A GASEOUS STATE ..	216
COMBUSTION, CAUSES THAT INFLUENCE THE RAPIDITY OF .....	218
HARMLESSNESS OF NON-ELASTIC FORCE .....	234

CONTENTS.

11

	ART.
PROOF OF POWDER .....	240
EPROUVETTE .....	241
BALLISTIC PENDULUM .....	244
LOSS OF FORCE BY WINDAGE .....	246
EFFECT OF JUNK WADS .....	247
EFFECT OF REDUCING WINDAGE .....	249
ROTARY MACHINE .....	260
NAVEZ'S MACHINE .....	261
STORAGE OF GUNPOWDER ...	280
DAMAGED GUNPOWDER .....	282
GUN-COTTON .....	283

CHAPTER VI.

PROJECTILES.

CASTING .....	287
INSPECTION .....	293
BAR-SHOT .....	304
CHAIN-SHOT .....	305
GRAPE-SHOT .....	306
CANISTER SHOT .....	307
SHELLS .....	309
SPHERICAL CASE .....	310
CARCASSES .....	313
SABOTS .....	315
MARTIN'S SHELL .....	316
NORTON'S LIQUID FIRE .....	317
RESISTANCE OF THE ATMOSPHERE .....	319
WINDAGE, &c. ....	320
DEVIATIONS .....	321
MAGNUS' EXPERIMENT .....	325
ECCENTRICITY, EFFECT OF .....	328
ADVANTAGE OF LARGE CALIBRE .....	338
ADVANTAGES OF THE SPHERICAL AND ELONGATED FORM .....	340
PENETRATION .....	346
ROCKETS .....	347
MANUFACTURE .....	349
CONGREVE ROCKET .....	361
MOTIVE POWER OF ROCKETS .....	362
UNCERTAINTY OF ROCKET PRACTICE .....	367
ROCKETS FIRED FROM CANNON .....	371
HALE'S ROCKET .....	372
HALE'S ROCKET TUBE FOR BROADSIDE FIRING .....	375

CHAPTER VII.

FUZES.

FUZE-CASE .....	381
SAFETY PLUG .....	384
WATER CAP .....	385

	ART
ENGLISH FUZE .....	388
SPLINGARD'S SHRAPNEL FUZE .....	390
BORMANN FUZE .....	392
FRENCH SHRAPNEL FUZE .....	396
CONCUSSION FUZES .....	397
PRUSSIAN FUZE .....	401
SCHONSTEDT FUZE .....	406
SNOECK FUZE .....	407
SPLINGARD'S CONCUSSION FUZE .....	408
PERCUSSION FUZE .....	413
MOORSOM'S FUZE .....	414
BOURBON FUZE .....	416
FUZE USED DURING EXPERIMENTS AT WEST POINT .....	418

## CHAPTER VIII.

## LOCKS AND PRIMERS.

EARLY METHODS OF FIRING CANNON .....	419
FIRST APPLICATION OF LOCKS TO CANNON .....	423
PERCUSSION SYSTEM .....	424
NAVY PERCUSSION PRIMER .....	428
ENGLISH PRIMER .....	429
NAVY LOCKS .....	430
LATE IMPROVEMENT IN MOUNTING THE HAMMER .....	432
FRICTION PRIMERS .....	433
ENGLISH NAVY FRICTION PRIMER .....	434

## CHAPTER IX.

## THEORY OF POINTING GUNS.

PRELIMINARY .....	435
TRAJECTORY IN A VACUUM .....	449
HEIGHT OF THE CURVE .....	452
RANGE .....	456
RESISTANCE OF THE AIR .....	459
ALL DEVIATIONS NOT DUE TO ERRORS OF POINTING .....	462
TRAJECTORY IN THE AIR .....	463
HEIGHT OF THE CURVE .....	468
ANGLE OF GREATEST RANGE .....	469
DIRECT FIRE .....	471
POINTING .....	472
POINT BLANK .....	474, 476 AND 485
TANGENT SCALE .....	475
NEGATIVE HAUSSE .....	480
DISPART SIGHT .....	481
USE OF GRADUATIONS BETWEEN "LEVEL" AND RANGE AT LEVEL .....	487
MARKING BREECH SIGHTS .....	488
RELATION BETWEEN TOTAL HAUSSE AND TIME OF FLIGHT .....	491
DEVIATIONS RESULTING FROM A DIFFERENCE OF LEVEL IN THE TRUCKS .....	492
CHASE FIRING .....	495

	ART.
PENDULUM HAUSSE . . . . .	496
SIDE POINTING . . . . .	497
POINTING BY MEANS OF THE HANDLES . . . . .	498
TANGENT FIRING . . . . .	499
RICOCHET FIRING . . . . .	500

CHAPTER X.

RIFLES.

INACCURACIES THAT THE RIFLE IS INTENDED TO CORRECT . . . . .	503
OBJECT OF THE RIFLE MOTION . . . . .	505
METHODS OF IMPARTING THE RIFLE MOTION . . . . .	506
BREECH LOADING, MAYNARD'S RIFLE . . . . .	508
DELVIGNE'S RIFLE . . . . .	509
RIFLE À TIGE . . . . .	510
GAINING TWIST . . . . .	513
THE HELIX . . . . .	515
BALL À CULOT . . . . .	516
PRITCHET BULLET . . . . .	518
UNITED STATES NAVY BULLET . . . . .	518
GREENER'S EXPANSIVE BULLET . . . . .	520
THEORY OF RIFLE MOTION, DRIFT . . . . .	521
ADVANTAGES OF THE ELONGATED FORM OF BULLET . . . . .	523
GROOVES ON THE BULLET, FRENCH THEORY . . . . .	525
MAGNUS' THEORY OF THE DEVIATION OF ELONGATED PROJECTILES . . . . .	530
RIFLED CANNON . . . . .	538
FRENCH RIFLED CANNON . . . . .	539
LANCASTER GUN . . . . .	540
CAVALLI GUN . . . . .	541
WAHRENDORFF GUN . . . . .	543
THE ARMSTRONG GUN . . . . .	545
THE ARMSTRONG SHELL . . . . .	550
THE ARMSTRONG CARRIAGE FOR BROADSIDE USE . . . . .	555
PROFESSOR TREADWELL'S PLAN FOR CONSTRUCTING CANNON . . . . .	558
THE WHITWORTH GUN . . . . .	560
ADVANTAGES OF RIFLED CANNON LIMITED TO LONG RANGES . . . . .	566
COMPARISON OF THE ARMSTRONG AND WHITWORTH GUNS . . . . .	569
OBJECTIONS TO BREECH-LOADING CANNON . . . . .	570
JAMES'S RIFLE SHOT . . . . .	571
SAWYER'S SHELL . . . . .	572
PARROTT'S RIFLED CANNON AND SHELL . . . . .	573
THE SCHENKL RIFLE SHELL . . . . .	577

CHAPTER XI.

PRACTICE OF GUNNERY.

DOUBLE SHOTTING . . . . .	580
EFFECT OF SHOT ON IRON . . . . .	584
IRON-CASED SHIPS . . . . .	588
JONES'S INCLINED SIDES . . . . .	591
COLE'S REVOLVING TOWERS . . . . .	592

	ART.
"LA GLOIRE" .....	593
THE "WARRIOR" .....	596
DETERMINING DISTANCE OF OBJECTS AT SEA .....	597
PRACTICE OF FIRING AT SEA .....	603
"HORNET" AND "PEACOCK" .....	612
"AVON" AND "WASP" .....	613
"FROLIC" AND "WASP" .....	614
LOADING IN ONE MOTION .....	617
EXPLOSION OF SHELLS ON CONCUSSION .....	618
CONCENTRATION OF FIRE .....	628
EFFECT OF PROJECTILES .....	633
NAVAL DUELS .....	639
"GUERRIÈRE" AND "CONSTITUTION" .....	640
RECEIVING AN ATTACK FROM TO WINDWARD .....	641
"MACEDONIAN" AND "UNITED STATES" .....	646
RECEIVING AN ATTACK FROM TO LEEWARD .....	647

# NAVAL GUNNERY.

---

## CHAPTER I.

1. **Ordnance and Gunnery.** Under the head of Ordnance is classed all that relates to the construction, equipment and preservation of guns, and the fabrication and care of shot and ammunition. Under the head of Gunnery is classed the drill of the personnel attached to a gun, and its skilful and most effective use.

2. **Importance of Gunnery.** In preparing a ship, and disciplining her crew for service, the fitness of her battery, skilfulness of her crew in its use, and the preservation of her military stores, should be regarded as among the objects of paramount importance; for she may in other respects be well provided, be clean, neatly rigged, and have an active crew, but if her battery be imperfect in its construction, condition or appointments, or if, through carelessness, or want of a proper estimate of its importance, the instruction and exercise be neglected, so that her gunnery is bad, she will most imperfectly fulfil, in action, the chief purposes for which she is to be employed.

3. **Design of Chapter I.** In opening the instruction proposed, it may not be uninteresting, or without its use in exciting a spirit of inquiry, to give an account of ancient arms in general, to notice briefly the ancient

modes of sea fighting, to give some account of the artillery employed by the Greeks and Romans, and during the middle ages until the application of gunpowder to cannon, and trace the invention of, and improvements in, cannon from their earliest use, through intervening maritime wars, to the present time.

4. **Arms.** Arms, in a general sense, include all kinds of weapons, both offensive and defensive; and among the earliest may be classed the bow and arrow, and the sling, they being the first means invented for projecting bodies with an offensive aim. The term *Artillery*, as formerly applied, was nearly synonymous with *Archery*.

5. **The Sling.** To the bow and sling were soon added spears, swords, axes and javelins.

The invention of the sling is attributed by ancient writers, to the Phœnicians, or the inhabitants of the Balearic Islands; the great fame that these islanders obtained arose from their assiduity in its use; their children were not allowed to eat until they struck their food from the top of a pole with a stone from a sling. From the accounts left us (probably fabulous), it appears that the immense force with which a stone could be projected can only be exceeded by modern gunnery. Even at that early age, leaden balls were in use as projectiles.

6. **The Bow.** The bow is of equal if not greater antiquity. The first account we find of it is in Genesis xxi. 20, where the Lawgiver, speaking of Ishmael, says, "and God was with the lad, and he grew and dwelt in the wilderness, and became an archer."

7. **The Cross-Bow.** To the Normans appears to be awarded the invention of the *cross-bow*, an instrument

which afterward became of great repute in England. It is said of the cross-bow that quarrels\* could be projected from them 200 yards, so that we may imagine the force with which one of these lumps of iron would strike even the strongest armor, as, to range that distance, the initial velocity would be not far short of 900 or 1,000 feet per second, nearly equal to the effect of a ball from a musket.

8. **Ancient Musqueteer.** This being the case, it is not to be wondered at that the musket had to struggle so many years before it grew so much into favor as to supersede the bow; for the musqueteer was formerly a most encumbered soldier. He had, besides the unwieldy weapon itself, his coarse powder for loading in a flask, his fine powder for priming in a touch-box, his bullets in a leathern bag with strings to draw in order to get at them, whilst in his hand were his musket rest and his burning match; and, when he had discharged his piece, he had to draw his sword in order to defend himself.

9. **Ancient Engines of War.** The structure of fortifications and that of offensive engines must mutually influence each other. In ancient times, before the invention of fire-arms, the strength of cities depended on the height of their walls; at the present time this would constitute a weakness; whilst, on the other hand, our modern low fortified walls would have been no defence against the ancient mode of attack. The forms of ancient engines of war may be included in the following classes:

- 1.—Catapulta, for projecting stones.
- 2.—Ballista, for projecting beams and darts.
- 3.—The Battering Ram.

\* *Carreaux*, from their heads, which were square pyramids of iron.

4.—The Tower of War, from which projectile weapons were thrown.

10. **Catapulta and Ballista.** The Catapulta and Ballista are both engines of the cross-bow kind, but employed for throwing different projectiles. In making these enormous cross-bows, instead of making the bow out of one piece, it was formed in two parts, each of which was merely a straight arm. To form the machine, each piece at its mesial extremity was closely matted in amongst the fibres of a rope placed vertically and firmly secured at either end. From this arrangement, the bow could not be bent without producing great tension of the rope, thus adding another force to that of the rebounding steel. A windlass or capstan was employed to bend these enormous bows, and when bent, the string was secured by a catch and iron pin. In order to discharge this machine, the pin was suddenly knocked out by the blow of a mallet.

Catapultæ have occasionally been employed in modern warfare. There was one erected at Gibraltar, by General Melville; it was for the purpose of throwing stones a short distance over the edge of the rock in a particular place where the Spaniards used to frequent, and where they could not be annoyed by shot or shells.

11. **Battering Ram.** Of all the ancient offensive weapons none were so efficacious as the Battering Ram. It consisted of a long pole or spar, headed with a huge mass of iron or brass, usually shaped like the head of the animal from which its name was derived. The spar was sometimes mounted on wheels, but more frequently suspended by cords from a triangle of stout beams. In

either case, the intention was to impel it violently forward against an opposing wall, not with a view of its penetrating the mass, or even of dislodging a portion by its immediate shock, but to generate a *vibration* that, continually repeated, would shake the strongest walls to their foundation, and eventually make them fall.

12. **Principle of the Ram.** It will be perceived, that the principle on which the *Ram* acted against walls was very different from that involved in the impact of shot fired from cannon; the latter impels a projectile with great velocity against the object, and penetrates and shatters, without much disturbing the repose of masses situated near its point of impact; the former possessed comparatively little penetrating force, but shook the strongest walls to their foundations. One of the most familiar instances of the effects produced by periodic vibrations is the well known result of marching a regiment of soldiers over a suspension bridge, when the bridge, responsive to the measured step, begins to rise and fall with excessive violence, and if the marching be still continued, most probably separates in two parts. More than one accident has occurred in this way, and has led to the order that soldiers in passing these bridges must not march, but simply walk out of time. The difficulty of destroying fortifications with modern artillery is leading the mind of artillerists to the invention of some way of operating on the principle of the *Ram*; it is supposed that this object will be, in a measure, reached by increasing the size of the projectile and diminishing the velocity with which it is fired, thus increasing its shattering, but diminishing its penetrating effects.

13. **The Tower.** The Battering Ram was generally employed in connection with the fourth engine enumerated above, the *Tower*. This tower was called *testudo*. The walls of ancient cities, as has been stated, were of great height. Against defenders stationed on high walls, soldiers attacking, armed with manual weapons, fought at a great disadvantage from the ground; the object, then, was to gain an elevation that commanded the city walls. This object was accomplished by means of towers of enormous magnitude. These towers were supported on wheels, the lower story was devoted to the battering-ram, all the others were filled with archers and light-armed soldiers generally. These large towers being brought up close to the wall, put the besiegers on a more equal footing with the besieged, in that they could discharge their missiles from the same height, and even, by means of a drawbridge, engage in hand to hand encounters on the top of the wall, while the ponderous ram would be, the while, thundering at the wall below. It was, of course, a great effort with the besieged to destroy these engines by fire, to guard against which the machine was usually covered with raw hides or metal scales, hence the name of *testudo* (tortoise), which, eventually, the whole engine acquired.

14. **Ancient Men-of-War.** The Greeks, and subsequently the Romans and other ancients, fought at sea in galleys propelled by oars, which were arranged in banks, one, two, and sometimes three deep. Their contests were principally decided by boarding, and depended much on personal prowess as well as on numbers. The galleys were constructed with heavy iron beaks, in order to destroy an opponent by piercing or crushing

its sides.\* It was customary however to use a species of artillery.

**Ancient Artillery.** The Greeks threw, by means of a machine, a composition known as Greek fire, which is represented to have been inextinguishable, and with which they destroyed an enemy while at a distance. It is now supposed that *naphtha* was the basis of Greek fire. Sometimes suffocating mixtures in earthen jars were thrown upon an enemy's deck to stifle and blind the crew, and venomous reptiles were thrown in the same way to produce terror and dismay. The catapulta was the light artillery of the ancients, which was fitted for use on their light vessels.

In the middle ages, especially during the crusades, various other means of annoying a distant enemy from vessels were devised; the English galleys used wind-mills, which, turning rapidly, threw, by centrifugal force, heavy stones, combustible balls, and other missiles. There are enumerated no less than twelve different machines for throwing missiles which had come into use in the 11th and 12th centuries, but their forms, construction, and manner of use, are entirely lost to history.

**15. Invention of Gunpowder.** In 1320, gunpowder was invented by Friar Schwartz, a German. There is reason to believe that an English monk, Roger Bacon, was acquainted with its properties in the preceding cen-

\* This method of destroying an enemy is not without favor in some minds even at the present time, particularly where a harbor is to be defended. Notwithstanding the high pitch of perfection to which the projectile system has been advanced, the desire of the combatant to close with his enemy is always apparent; even in the last Italian campaign of the French, although much execution was done with the minié rifle and rifled cannon, the most decisive advantages were gained by a resort to the charge of bayonets.

tury, but Schwartz seems to have the credit of applying it to military uses. It is said that he was operating in a mortar on a mixture of nitre, charcoal and sulphur (gunpowder in fact), and accidentally firing the mixture it exploded, urging the pestle to a considerable distance; that hence originated cannon, and also the military term *mortar*, as applied to a particular variety of cannon.

16. **Ancient Cannon.** The term cannon is derived from *canna* (a reed); the first cannon were called *bombardæ*, from the great noise which the firing of them occasioned.

The first cannon employed were nothing more than bars of iron arranged in such a manner that their internal aspects should form a tube; the bars were not welded, but merely confined by hoops. On some occasions, expedients much less efficient than this have been had recourse to, cannon having been made of coils of rope arranged in a tubular form, and even of leather or wood.

17. **Earliest uses of Cannon.** The earliest uses of this new description of artillery are noticed as having occurred at Cressy in 1346, where they were employed on land by the Black Prince; and at sea in 1350, in an action between the Moorish king of Seville and the king of Tunis, and again by the Venetians in 1380. On this last occasion it is remarkable that nations generally exclaimed against its use as unfair in war. It was not then foreseen, as has since proved the case, that gunpowder would render war, especially in naval battles, less sanguinary. Formerly, the great object in sea engagements was to board the enemy, and in hand to hand combats destroy life; but the chief effort now in fighting ships with guns, is to cripple or destroy the ship, which

being accomplished, men are compelled by necessity to surrender.

18. **Advance in Gun Making.** The second step in gun making produced brass ordnance of enormous calibre, throwing stone balls of a weight equal to 600 pounds, and in some instances, it is said, reaching to 1,200 pounds. Louis XI. had a celebrated gun of this calibre, and Mahomet II. breached the walls of Constantinople, at the siege of that city in 1449, with a gun of this description. Next, both wrought-iron and brass cast guns came into use, of a much reduced size, throwing cast-iron balls.

19. **Ancient Wrought-iron Cannon.** These wrought-iron guns were composed of a tube of iron, whose joint or overlap was in the direction of the length; upon this is a succession of iron hoops, composed of iron three inches square, being, in fact, immense rings; these appear to have been driven on while redhot, and thus, by their contraction, forming a much stronger gun when combined with the interior tube than the generality of accounts given of ancient guns would lead us to expect. There have been recovered from the "Mary Rose," an English vessel of war sunk by a French fleet on the coast of England in 1545, several guns, some of wrought iron, constructed as just described, and others of brass, cast. One of the brass guns contained an iron ball. Some of these iron guns are in an excellent state of preservation, considering that they have been immersed above 300 years.

20. **Ancient Breech-loading Cannon.** These guns all appear to have been loaded by removing a breech part or chamber, inserting the charge at the breech, replacing

the chamber, and securing it by wedging it behind. No means of raising or depressing the muzzle appear available, the barrel or gun being sunk in a large block of timber, and secured there by bolts, as a musket barrel is secured in its stock, while a large piece of iron, or wood, was inserted perpendicularly into the deck to prevent recoil. The advantage of *chambers* was understood even at this early period; they were apparently slightly conical, with a spherical bottom.

21. **Introduction of Cast-iron Cannon.** It was not until so late as 1558, when cast-iron guns were introduced, more than two hundred years after the discovery of gunpowder, that cannon were so securely made as not to produce, by their liability to burst, as much apprehension amongst those who served them as amongst the enemy, and until that time had not entirely superseded the ancient artillery. The method of constructing the ancient artillery, as described above, seeming to have been sufficiently strong, the inference appears reasonable that the danger attending the serving of the pieces arose from the rude system of breech-loading which was then practised. It has tasked all the ingenuity of the present day to make a successful application of the breech-loading system, and even the specimens that we see in service are considered by many as inferior in strength to pieces loading at the muzzle.

22. **Causes tending to increase the importance of Maritime Wars.** Late in the thirteenth, or early in the fourteenth century, the polarity of the needle was discovered. The Portuguese had, by aid of it, ventured largely on the ocean, but its great effects were developed in the voyage of Columbus, which resulted in the discovery of the

western world in 1492. The Portuguese had, six years before this, coasted the whole western shore of Africa and doubled the Cape of Good Hope, and six years later, 1498, the same people discovered the passage to India. The ocean, which had been a barrier between nations, now, through these discoveries and by aid of the compass, became a convenient highway of communication. The Venetians in the Mediterranean, the Portuguese in the East, and Spaniards in the West, held possession and attempted a monopoly of the commerce of those regions. Nations contended for and against this monopoly; maritime wars, in consequence, assumed an importance they had never before held, and gunpowder rendered them formidable and destructive.

23. **Battle of Lepanto.** The first great naval combat, growing out of this state of things, was fought at Lepanto between the Turks and Venetians in 1577; the vessels on both sides were mostly galleys armed with light cannon, the Venetians, however, had six ships showing, through port-holes, three long heavy guns on each side. These ships withstood the whole Turkish force, and contributed mainly to the result of that bloody day. This is the first notable instance on record of the *decisive effect of a small number of heavy ordnance over a larger number of smaller calibre.*

24. **Armada of Philip II.** In the year 1588, Philip II. of Spain astonished the world with the celebrated "Armada," which threatened the coast of England, but was defeated and finally wrecked or otherwise destroyed in the British seas. That fleet consisted of 132 vessels, with an aggregate tonnage of 63,120, carried 3,165 guns and 30,000 people, including soldiers. The largest of

these vessels measured 1,550 tons, carried 50 guns and 422 persons; another of them, of 1,200 tons, carried 50 guns and 360 persons; this last was about the prevailing proportion of tonnage, guns, and men throughout the fleet. The English force opposed, consisted of 175 ships of 29,740 tons, and 14,500 men.

25. **The Royal Prince.** The "Royal Prince," a British ship built in 1610, twenty years after the "Armada" was destroyed, was of 1,500 tons burden, and carried 55 guns; of these pieces 2 were *cannon petronel*, or 24-pounders, 6 were *demi-cannon* (medium 32-pounders), 12 were *culverins* or 18-pounders, which were nine feet long with 177 pounds of metal to 1 of shot, 18 were *demi-culverins* or 9-pounders, 13 were *rakers* or 5-pounders, 6 feet long with upwards of 200 pounds of metal to one of shot, and 4 were *port-pieces*, probably swivels. These guns were disposed as follows: on the lower gun-deck two 24-pounders, six medium 32's, and twelve 18's; on the upper gun-deck the battery was entirely of 9-pounders; and the quarter-deck and fore-castle were armed with 5-pounders; and the brood of pop-guns that, in those days, swelled the nominal armament of ships.

26. **The Sovereign of the Seas.** In 1637, Charles I. built the "Sovereign of the Seas," more famous than any ship which had preceded, and unequalled by any afloat in her time. She mounted on three gun-decks 86 guns. On the lower deck were thirty long 24's and medium 32's; on her middle deck thirty 12's and 9's; on the upper deck "other lighter ordnance;" and on her quarter-deck, fore-castle and elsewhere, "numbers of murdering pieces." This shows an increase in the size

of ships and number of guns since the preceding reign, but it may be remarked that the increase is principally in lighter ordnance and "other murdering pieces," so that according to our modern estimation, little addition was made to real and substantial efficiency.

27. **Mortar.** It may here be remarked, in the chain of improvement in naval ordnance, that the mortar was first used afloat in 1679, at the French attack on Algiers; it was then discharged from a bomb ketch, precisely as at the present time; the ketch rig was invented then, and is continued without change.

28. **Character of Naval Conflicts in the time of Cromwell.** In the severe and obstinately protracted contests between Blake and Van Tromp in Cromwell's time, it does not appear that the ships or batteries differed in any material degree, from those cotemporaneous in construction with the "Sovereign of the Seas." Indeed, with a single exception, that ship remained at the time of the British revolution, a whole reign after Cromwell's death, the most formidable ship, both in size and battery, in the British navy. This, if the Dutch ships were similarly armed, explains how those ships could fight a battle that was protracted through three days; for, as will hereafter be seen, there were few guns in either fleet capable of penetrating a heavy ship's side and sinking her, even at close quarters. Armed as ships now are, and with tolerable gunnery, one or both must be destroyed in a few hours at most.

29. **Introduction of Carronades.** No marked alteration in the batteries of ships appears to have occurred down to the destruction of the French and Spanish maritime power at Trafalgar, in 1806. Carronades of small

weight and great calibre had taken the place in many cases of the 9 and 12-pounder long guns. Carronades are a short description of ordnance without trunnions, but having a loop under the reinforce which sets between lugs on a bed, a bolt passing through the lugs and the loop; the bed is mounted on a slide. The name is derived from the Carron foundry in Scotland, the first pieces of the kind having been cast there in 1779. They were of large calibre and of light proportional weight, the charge of powder was small, but at close quarters they were very effective. In the composition of the batteries of the ships already cited, one great objection is the variety of calibres that were crowded together in the same ship, and sometimes on the same deck; of course each calibre had its own ammunition, which was required to be stowed separate from the ammunition of the other calibres, thus multiplying difficulties of stowage, and complicating the work of the powder division; the introduction of carronades operated to a considerable degree in bringing about an approach to uniformity of calibre. How far this is true will appear by stating the batteries of the "Santissima Trinidad," the heaviest ship of the combined fleet, and of the "Victory" and others of the British fleet.

30. **The Santissima Trinidad.** The "Santissima Trinidad" was built in Havana, in 1769; she then mounted 126 guns, viz.: on the lower gun-deck thirty long 36-pounders; on the second deck thirty-two long 18's; on the third deck thirty-two long 12's; and on the spar-deck thirty-two 8-pounders; at Trafalgar she is said, in the British accounts, to have had 140 guns, which number must have included swivels mounted for the occasion.

The Spanish 74's in that action had fifty-eight long 24-pounders on the gun-decks; on the spar-deck ten iron 36-pounder carronades, and four long 8-pounders; and on the poop six iron 24-pounder carronades, total 78 guns. The French and Spanish ships had coehorns\* mounted in the tops, and one or two field-pieces were movable on the spar-deck.

31. **The Victory.** The "Victory," the English flagship, on board of which Lord Nelson fell, mounted on her three gun-decks ninety long 32, 24 and 12-pounders; and on the quarter-deck and forecastle ten long 12-pounders, and two 68-pounder carronades.

32. **The Tamerlane.** The British ship "Tamerlane," the best armed for her rate in the fleet, had fifty-six long 32-pounders, and thirty long 18-pounders on her gun-decks, and on the spar-deck twelve 32-pounder carronades, and four long 18-pounders.

At a single broadside the weight of metal thrown by the "Santissima Trinidad," was 1,190 pounds, by the "Victory," 1,180 pounds.

The United States ship Minnesota throws a weight of 1,700 pounds of metal at a broadside.

33. **Resumé of the History of Calibre.** In thus briefly tracing the history of ordnance, it will be observed that early fabricators, adopting the idea of the ancients in favor of missiles of the most ponderous practicable dimensions, constructed guns of mammoth proportions to contain those missiles. It was soon found, however,

\* The Coehorn is a very light mortar, projecting a large projectile with a small charge of powder; it is probable that its projectile was intended to operate by means of the force of gravity when the ships should be within its short range. A heavy projectile falling from a great height and landing on a ship's deck might do much damage.

that those guns were too heavy for transportation or manœuvring, and their shot too heavy for handling with that facility essential to rapid firing. Both guns and shot were therefore reduced in calibre and dimensions, and for the shot a denser material, iron, was introduced. Iron shot first came in use about the year 1490. Lead-en shot, still more dense than iron, were, as has been remarked, employed at an earlier date, but that substance proved too soft as well as too costly.

In reducing the calibre of guns, the world proceeded from one extreme to another, and until within forty years regarded the 18-pounder as that which afforded the happy mean, between too light a gun on the one hand for effect, and too great weight on the other for convenient manœuvring and rapid manipulation. Accordingly the 18-pounder came into use as the favorite battering piece. The next higher calibre was used occasionally on the lower decks of heavy ships, whose antagonists commonly had thick sides requiring shot of greater penetration than the 18-pounder.

But for the upper decks of ships, this favorite gun was found too heavy, besides occupying, owing to its length, too much room. Nine-pounders were therefore substituted on these decks. But that calibre did not give momentum or weight of blow enough for effect; this suggested the carronade, of greater calibre and lighter weight, invented by General Melville, and introduced in 1790. A 32-pound carronade and carriage weighs but little if any more than a long nine and carriage; no weight was added therefore by substituting the 32-pounder carronade for the long 9-pounder, but much was gained in effect, especially at short ranges, for

(momentum being equal to the product of weight and velocity) if the shot of 9 pounds were discharged with an initial velocity of 1,500 feet per second, and the 32-pound shot with a velocity of 750 feet per second, the momenta of the respective shot would be 13,500 for the 9-pound shot and 24,000 for the 32-pound shot, the 32-pound shot having almost double the percussive force, although discharged with an initial velocity of only half that of the smaller shot. What the carronade lacked in accuracy, in consequence of its reduced charge and length, was thought to be compensated by the greater niceness of its bore, and the reduced windage of its shot, for the art of boring guns was formerly so imperfect that a long gun could not be bored so uniformly as to admit safely the reduced windage admissible in a shorter carronade bore. This distinction between the bores of carronades and long guns existed for some years, and, when existing, was not generally known. The carronades had from sixty to eighty pounds of metal for every pound of shot, few guns are now cast with less than one hundred pounds of metal to one of shot. This increase of metal admits of heavier charges, which give increased range of shot and still more increased accuracy.

**34. Experience of the War of 1812.** The experience of our war of 1812 with Great Britain taught another lesson, which was, that if the long 18-pounder be a happy medium, the long 24, with which our frigates were armed, was a still happier mean; for the "United States," owing in a measure to this difference of calibre, cut up the "Macedonian" most dreadfully, without herself receiving a corresponding damage.

**Maximum Calibres now in use in the U. S. Navy.** Profiting by this lesson, we have gone on steadily increasing the calibre of our naval batteries; the eight-inch shell gun and the 64-pounder, for throwing solid shot, have been introduced, and are acknowledged to be most efficient guns for the service required of them. We have not stopped at these, for the guns of nine-inch and even eleven-inch calibre which have been introduced into the service, are proved to possess, within their limited range, more accuracy and power than any guns that have preceded them, while the weight of the shells that they throw are not so great as to prevent rapid manipulation. Of course, if the former number of guns be retained, ships of increased capacity will be required to carry the heavier battery and the consequent increase of men, provisions, &c.; but, supposing the capacity of the vessels to remain the same, it is now thought better to have wide quarters and carry a less number of large guns than a greater number of small guns.

## CHAPTER II.

## FABRICATION OF CANNON.

35. **Substances used in the Manufacture of Cannon.** But three substances have been hitherto employed in the manufacture of cannon, viz. : cast iron, wrought iron, and bronze, which is an alloy of copper and tin. Other substances have been found either too expensive, or deficient in hardness and tenacity.

36. **Cast Iron.** Cast iron is much used on account of its cheapness of first cost, but its toughness has not been considered sufficiently great for the pieces used in field-service ; it is chiefly used in the manufacture of cannon for the navy, and for the defence of coasts and fortifications ; in these, the weight required to give the necessary strength is not very objectionable, as it diminishes recoil.

37. **Wrought Iron.** The tenacity of wrought iron renders it superior to all other metals for the manufacture of cannon, but the difficulty of forging it in masses of sufficient size, has hitherto been such as to prevent its being brought into common use. The impossibility of welding such a large mass of iron, so as to insure a perfect soundness and uniformity throughout, was made sufficiently apparent in the famous gun which burst on board of the "Princeton," the metal of which was, after the accident, examined by the Committee on Sci-

ence and Arts constituted by the Franklin Institute of the State of Pennsylvania, which committee reported the iron had decreased very much in strength from the long exposure to the intense heat necessary in making a gun of that size, while it was impossible to restore the fibre by hammering, the strength before and after welding being about as 6 to 5. Some guns of smaller size have been made, however, and with such success, as to render it probable that wrought iron or steel will be extensively used, especially for rifled field cannon. Pieces of this material may be made very light, but their carriages will be strained accordingly.

38. **Copper.** Though copper has too little hardness to be employed alone in the manufacture of cannon, when alloyed with some of the other metals it becomes an excellent material for that purpose. When alloyed with zinc in proper proportions, its hardness becomes very much increased; but the difficulty of making this alloy, has caused its use in the manufacture of cannon to be abandoned.

39. **Bronze.** When copper is alloyed with ten per cent. of tin, its hardness is very much increased, while its tenacity is comparatively little diminished. This alloy is generally considered the best for the manufacture of cannon. For light pieces, especially for field cannon, bronze is much used, but there are many objections even to this alloy. As the tin is much more fusible than the copper, and must be introduced when the latter is in fusion, it is difficult to seize the precise moment when the alloy can be properly formed; part of the tin is frequently burned and converted into scoria. The fusibility of tin is such also as to render it liable

to melt by slow degrees during the heat of a brisk cannonade, and thus bronze pieces sometimes become soft and spongy about the bore. The gases produced by the combustion of gunpowder, also produce an injurious effect upon this kind of piece by acting chemically on the bronze.

40. Bronze is the material of those pieces which are commonly, but improperly, called brass cannon. To prepare this alloy, the larger pieces of copper are first placed in the furnace, and so arranged as to be easily enveloped in the flames; the fire is then kindled, and the heat raised by degrees, until, at the expiration of six or seven hours, the copper is entirely fused. The metal is next stirred with long wooden poles, which increase the agitation by their combustion; the scoria which rises to the surface, is at the same time carefully removed. About an hour before the casting is to take place the tin is introduced in small pieces, and scattered as equally as possible over the surface of the melted copper; the stirring is at the same time recommenced, and continued with as much activity as possible, until the casting takes place.

41. It is a singular fact, that the ancient composition of bronze has remained almost unchanged to the present day, and the metal from cannon is found to be almost identical in the proportions of copper and tin with the rude weapons of Scandinavian, Celtic, Egyptian, Greek and Roman warfare. The amount of tin in bronze varies in different countries from 9 to 12.5 parts to 100 of copper: 12.5 parts are used in this country; and in France, 11 parts is fixed by law as the proper amount.

As with many other metallic alloys, the combination between the two metals in bronze is so imperfect, that very slight forces are sufficient to cause its separation into two or more different alloys, which, on cooling, are found to occupy different portions of the mass. In casting a gun, for example, the outside, which cools first, has a constitution different from that assigned by the proportions of the metals, as fixed for fusion. The interior, which cools last, has another, different from both, and always richer in tin. On being examined after cooling, portions at different heights are found to differ from each other; and this difference varies along the exterior and interior portions, so that no two adjacent portions have strictly the same chemical constitution; the maximum of copper being found in the exterior and breech of the gun, making these portions less flexible, and the maximum of tin in the interior and higher parts.

42. Specimens taken from the top and bottom of the casting, show also a very great difference in density and tenacity, the density at the breech being much greater, and the tenacity, in one instance cited, more than double. The *sinking head* (which is the additional length cast on the muzzle of a gun) is, in consequence of these facts, made much longer in casting bronze guns than is otherwise necessary.

43. It is found that the constitution of the alloys changes not only in cooling, but in melting, as is made apparent, when the furnace is charged with old cannon instead of copper, by the reduction of the quantity of tin, which oxidizes much faster than the copper; and this takes place at such a rate, that after six successive meltings the amount of tin is reduced one half.

44. Very rapid cooling is considered most advantageous for bronze pieces, and as the cooling will be slower in proportion as the temperature of the metal when poured into the mould is higher, it results that, the lower the temperature at which the metal remains sufficiently fluid to fill the mould perfectly, the better will be the gun when cast.

45. It has been supposed that it would be advantageous to add a little zinc to the alloy of copper and tin, to give additional hardness. It has also been proposed to give a lining of wrought iron to the bore of the piece, by casting the bronze upon a wrought-iron core of the proper size, previously coated with tin, but additional experiments are required before either of these propositions can be adopted.

46. **Cast Iron.** Though bronze is superior to cast iron in tenacity, the latter has the advantage of being harder, less fusible, and less expensive. Moreover, as it is more liquid when fused, and contracts less in cooling than bronze, it makes a more perfect casting, especially on a small scale. But in large castings, the moulds are more injured on account of the greater heat required for the melted metal, which will frequently have the effect of deforming the exterior of the casting; on this account, and by reason of the difficulty of correcting the form of cast iron, it cannot be substituted for bronze in large castings which have minute details.

47. **Preparation of the Ore.** Native iron is never found in quantities sufficient for any useful purpose, but, in combination with other substances, it is one of the most abundant minerals in nature. From the different ores of iron, and the different modes of reducing them, the

metal is obtained in a great variety of conditions; but cast iron, wrought iron, and steel are the three classes under which all these varieties are included.

When the ore is raised from the mine, it is picked so as to separate it as much as possible from the earthy and refractory matters it may contain, and then roasted in furnaces, or in the open air, to expel the water, arsenic, and sulphur. This last foreign ingredient has a very injurious effect upon the quality of the iron, for it hardens it, and, unless in a very small proportion, destroys its tenacity. The furnaces used for roasting are sometimes constructed in such a manner that the process may be continued without interruption, and the ore removed, as it becomes sufficiently calcined, from the roasting to the smelting furnace; but generally a layer of coarse fuel is placed upon the ground, and upon this the ore and some kind of coal are piled in alternate layers to the height of several feet. The fuel is then burned away, the ore loses its vitrious lustre, and becomes friable and full of fissures, it is then broken into small pieces, and carried to the smelting or blast furnace, into which it is thrown with some kind of flux, and coke, or charcoal, in due proportion. The ore is here reduced, and the flux (either oyster shells or limestone), by uniting with the principal impurities, forms a glass, which separates from the metallic iron in the form of scoria. Iron obtained by this process is called cast iron.

The smelting furnace is a strong brick furnace, from thirty to fifty feet high, egg-shaped, with the point up, lined with fire brick, open at the top for feeding, and with a receptacle at the bottom to catch the molten

material of the ore as it flows; for the ore all melts, the earthy and metallic portions both, and flows down together.

The furnace is charged at the top, by throwing in kindling, then coals or coke, whichever of them is to be used as fuel, then ore and flux mingled. By repeatedly alternating a further supply of fuel, ore, and flux, in this order, the furnace becomes filled to the top, or "charged."

The furnace being thus charged, the fire is kindled at the bottom, and combustion of the fuel is promoted by a strong blast, kept up with a steam-engine, or water power; but the mass of the charge does not get into a perfect heat under several days. This blast is usually cold, though sometimes it is hot for charcoal and coke-charged furnaces. It is thought to be generally, if not always, a hot blast when anthracite coal is the fuel used. The cold-blast charcoal iron ranks first in quality, the hot-blast charcoal iron second, the anthracite iron third, then the coke, and last, the pit-coal iron.

48. **Smelting.** The use of coals instead of wood, in the process of smelting, has introduced a mixture which is very prejudicial. Most of the coal, even from the best mines, contains a large quantity of pyrites, or bisulphuret of iron, which, combining with the cast iron, injures it to an incalculable extent. Greener, speaking of English cast iron, says: "These facts fully explain why our cast-iron guns are not so good now as formerly. Select the most suitable mine in the kingdom, erect a furnace on the most improved principles, employ wood fuel only, avoid fluxes, and hot and cold blasts, and be content with the *small amount* of metal produced, and

beyond all doubt, the *quality* will be all that the most sanguine founder or artillerist could wish."

49. It is laid down that iron for our cannon must be of the best quality of *charcoal* iron, collected in sufficient quantity to cast at least one hundred guns, or, if a less number be contracted for, the quantity shall be sufficient for the whole number of guns to be made. The iron shall be inspected by persons appointed by the chief of the bureau of ordnance, &c., whose opinion will be taken as to its quality. When iron for the manufacture of the guns of a contract gives satisfactory results upon inspection, the chief of the bureau may have a trial gun cast, which shall be subjected to such proof as he may direct and specify in the contract. Should the trial gun fail to be satisfactory, the metal may be rejected, and other metal provided, or the contract be annulled.

50. **Cast Iron.** The iron for cannon must be charcoal iron, made in a smelting furnace, with a cold blast, and should be selected especially with regard to its strength. There are two principal varieties of cast iron, the gray and the white; the iron suitable for cannon should be soft, yielding easily to the file or chisel; its fracture an uniform dark gray, brilliant appearance, with crystals of medium size. This iron is distinguishable from the other principal division (the white) by being softer and less brittle, slightly malleable and flexible, and not so sonorous. The color of its fracture is lighter as the grain becomes closer, and the hardness increases at the same time.

A medium-sized grain, bright gray color, lively aspect, fracture sharp to the touch, and a close, compact

texture, are the characteristics of a good quality. If the grain be very small or very large, or the iron present a dull, earthy aspect, loose texture, or dissimilar crystals mixed together, the metal is of an inferior quality. If the iron is too soft, loose and coarse, its strength and elasticity may be increased by remelting it once or twice, and by continuing it in fusion several hours under a high heat.

Gray iron melts at a lower temperature than white, becomes more fluid, and preserves its fluidity longer; it runs smoothly, the color is red, and deeper in proportion as the heat is lower; it does not stick to the ladle; it fills the mould well; contracts less, and contains fewer cavities than white iron.

51. The mean specific gravity of pig-iron is 7.0, and its tenacity about sixteen thousand pounds to the square inch, which are both increased in the gun, the former slightly, the latter to between twenty-five thousand and thirty thousand pounds.

52. White iron is very brittle and sonorous; it resists the file and chisel, and is susceptible of high polish. The fracture presents a silvery appearance, and, compared with gray iron, is comparatively smooth. The differences between the two, when placed side by side, are very marked. When melted, it is white, and throws off a great number of sparks, but is seldom used by itself, without being mixed with a superior quality of iron. A mixture of the two kinds (white and gray) is generally used in making shot and shell, where strength is not of the same importance as in guns.

Besides these two divisions, manufacturers distinguish more particularly the different varieties of pig-iron by

numbers, according to the hardness, No. 1 being the gray, and No. 6 the white iron.

The gray iron is known by the formation of graphite, which takes place upon its surface when it is melted and slowly cooled. This substance is an indication that the iron has been highly carbonized. If the carbonization be carried too far, the iron becomes of a dark gray or black color, and loses its tenacity. From this it appears that the tenacity of cast iron is improved by union with carbon to a certain extent, but that it is injured by excess.

53. **Wrought Iron.** Wrought iron is cast iron reduced to the pure metallic state by burning and working out all the carbon and remaining oxygen. The process which effects this is termed *puddling*, and consists in stirring the molten iron, collected in sand pools or puddles, whilst it is cooling in them; which operation brings the carbon of the iron and the remaining oxygen of the iron into union, for combustion of the carbon. Continued stirring further exposes the remaining carbon in the iron to a union with the oxygen of the atmosphere for further consumption.

Whilst the carbon is thus burning out, the iron, by cooling, thickens to a certain consistency, in which state it is gathered into balls, called *puddle-balls*, of convenient size for management. These balls are next placed under a trip-hammer, then in a rolling-mill, and by hammering, reheating, and rolling, they have all earthy impurities worked out, the product being pure metallic bar and rod iron. In this pure metallic state it is malleable, and will forge or burn, but will not melt.

By rolling the iron it becomes fibrous, with a grain

which lies in the direction of the roll; and, in forging the iron, to any particular use, the direction of the grain is always taken into account, and retained in a position longitudinal to the work.

54. **Steel.** Steel is a product of a recombination of the metallic iron with a minute proportion of carbon, which is more intimately and evenly diffused in steel than it is in cast iron. This reunion of the iron and carbon is effected by a process termed *cementation*, which is simply baking carbon into the iron, all air being excluded. Imbed bar-iron in pulverized charcoal; cement it, thus imbedded, in a crucible to exclude air; then expose the crucible and its contents to a high heat, and as the carbon cannot consume for want of air, it becomes redhot, and burns or bakes itself into the iron. This makes *bar steel*, called also blistered steel, which is a metal that forges, and is more ductile than bar iron.

But, because of the carbon the bar steel contains, it will also melt. When it has been melted or run into ingots, it is called *cast steel*, a metal which forges, and from which the finest cutlery is made.

Refined steel, therefore, which has about one per cent. of carbon, is a metal that both forges and melts. Cast iron, with five per cent. of carbon, only melts, and wrought-iron, having no carbon, only forges.

It follows, from the foregoing, as cast iron has five per cent. of carbon, steel one per cent., and wrought iron none, that at the period of the puddling process, when all but one per cent. of the carbon is worked out, the metal is really steel. Hence it is commonly said that all wrought iron has once been steel. And if, in the puddling process, at the period when it is steel, the further

escape or consumption of carbon be arrested by piling on ashes or excluding the air in any other way, the puddle-balls will cool as puddled steel. When reheated, these balls will roll into plates, and though not so readily melted as the cemented steel, will yet fuse, but under a much higher heat than cast iron requires.

Puddled steel is comparatively a cheap, coarse article, and is the metal proposed for use in *cuirassing* ships of war. Refined steel, made by the process of cementation, could not be produced in sufficient quantities for this purpose.

55. **Moulds.** Iron, brass, and other metals, which melt at high temperatures, are generally cast in moulds made of sand. The sand most used for this purpose is a kind of loam, which contains a sufficient quantity of clay to render it moderately cohesive when damp. Sand, possessing all the qualities required for moulding, is seldom, if ever, found in a state of nature, but when the requisite qualities are known, the materials may be selected, and an artificial composition produced without difficulty. The sand should be principally of silex, very refractory, and of the kind commonly called sharp sand. When not sufficiently refractory, the sand is vitrified by the high temperature of the melted metal, and protuberances are formed upon the casting, which are not easily removed.

56. **Moulding Composition.** The method of preparing the moulding composition artificially varies according to the kind of casting for which it is to be used. In preparing it for cannon, great care should be taken to introduce the exact quantity of clay required. When too little is used, the composition is not sufficiently adhesive;

when too much is used, the mould is injured by contraction in drying. The sand, or the several kinds of sand when more than one are used, is first carefully sifted and then moistened with water in which clay has been stirred; the composition is considered sufficiently adhesive when it will retain its form after having been taken in a moist state and squeezed in the hand.

The same composition may be repeatedly used for moulding, but as the adhesive property of the clay is destroyed by the heat to which it is exposed in casting, more clay must be added every time, in the same manner as when the composition is first formed.

57. **Models.** Models for casting should be made of one or several pieces, according to the form of the mould required. When the form is such that the whole model can be withdrawn from the sand at once without injuring the mould, a single piece will suffice; but generally the model is composed of several pieces so fitted that they may be put together in succession as the moulding progresses, and finally taken apart and removed by piecemeal when the moulding is complete.

58. **Model for Cannon.** A model for cannon is composed of four parts, one for each trunnion, and one for each half of the body of the piece. The two half-patterns are divided by a plane passing through the axis of the piece, and perpendicular to the axis of the trunnions. Each trunnion model is so made that it may be attached to the corresponding half-pattern by a bolt with a nut and screw; and the two halves are made to fit each other by placing bolts in one and making corresponding holes in the other. The model should be of the exact form and size of the cannon, with the excep-

tion of a square knob at the extremity of the cascable, and an additional length at the muzzle of the piece. The knob is required for holding the piece when it is bored, and the additional length is necessary for the purpose of allowing the impurities of the metal to rise and accumulate in a part called the *sprue head*, or *dead head*, or *sinking head*, which is afterward cut off. The contraction of the metal, while cooling, renders it necessary to have an excess in the sinking head to supply the mould, and the greater this excess the more perfect will be the casting about the muzzle of the piece, in consequence of the greater pressure upon the metal in that part.

Models are generally made of wood, but those of iron, and especially those of copper are preferred, on account of the greater smoothness which can be given to their surfaces, and the greater ease with which they may be extracted from the moulds.

For the heavy guns now becoming common, a half pattern is too heavy for handling; consequently the division is into a greater number of parts, sometimes six, made by cutting transversely instead of longitudinally, and some of these parts may be again subdivided lengthwise. Thus the muzzle part is a separate piece, and if it has a ring on it, so that if moulded as one it will not draw out from the sand, the pattern must be subdivided in direction of the axis and made into half patterns. The chase is another part, and when moulded in a cylindrical flask, will withdraw from the sand by its larger extremity. The trunnions are two other parts of the pattern, the reinforce another, and the base of the breech another. These several parts are capable of

being handled and moved with ease, and are put together so as to form one model.

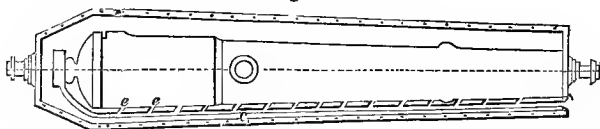
59. **Flasks.** Two flasks are required for moulding a gun, and each should be large enough to contain half the mould. These flasks are made of cast-iron plates, united together by bolts and screws. There are rings, hooks, and bolts on the sides and extremities of the flasks, for convenience in suspending them, moving them about, lowering the mould into the pit to receive the casting, &c. A trunnion box is cast upon each flask at the place to be occupied by the corresponding model of the trunnion, and closed by a plate secured by bolts.

60. **Process of Moulding.** When a gun is to be moulded, one of the flasks is placed upon the ground with the trunnion box downward, the trunnion model is introduced and the sand or moulding composition rammed compactly around it. The sand must be introduced in small quantities at a time, and rammed with iron bars having small knobs at their extremities, in order to render it sufficiently compact and of uniform hardness throughout. When the trunnion box is filled, one half of the model is fixed in its place and fastened to the trunnion model by the bolt and screw. Sand is again introduced and rammed until it rises to a level with the upper surface of the half-model and the flask is filled. A kind of white sand, called parting sand, is now sprinkled over the surface to keep the two parts of the mould from sticking together, and the other half of the model placed upon the first. The second flask being next bolted in its place, the upper plates are taken off, and sand introduced and rammed until the flask is filled, with the exception of a part about the trunnion.

The remaining trunnion model is then fixed in its place, the upper plates of the flask screwed on, and the trunnion box, having been filled with sand, is closed by a plate, which is firmly bolted in its place. The flasks are now separated, and each is found to contain one half the mould, with the corresponding parts of the model imbedded; and, as the latter are removed, the surface of the mould is smoothed by trowels of the forms required to fit the mouldings of the piece. The trowels should be dipped in water occasionally to make them pass easily over the surface. When the moulding composition is not sufficiently hard and tenacious, the interior of the mould may be coated with pulverized fire-brick, which can be put on with a trowel when moist.

61. A flask containing one half the mould is represented in fig. 1; the channel *cf*, and the smaller chan-

Fig. 1.



nels *e, e*, are made for the purpose of introducing the metal on one side, and allowing it to flow into the mould with a gentle current which will not injure its form. The channel *cf* is made by imbedding a rod in the sand between the two flasks in moulding the piece, and the smaller channels are scooped out with trowels.

62. When the interior of the mould has been rendered perfectly smooth, it is covered with pulverized charcoal, coke, or black-lead, to prevent the metal from coming in contact with the sand. Coke, which is preferred to the other two for this purpose, is prepared by

grinding it, and then making it into a kind of wash by mixing it with water in which clay has been stirred. A coating of this wash having been put on with a brush, the mould is mounted upon a car, and conducted upon a railway into a drying room, where a considerable heat is required for twenty hours to render it dry enough for use. When the mould is dry it is withdrawn from the drying room, again coated over with coke-wash, and is ready for use. The drying room is commonly of brick or stone masonry, arched, and furnished with an opening at the top for the escape of vapor and smoke.

63. **Cranes.** Cranes are employed for moving cannon, moulds, and other heavy masses about the foundry. The cranes should be about sixteen feet high, and should have an arm about twelve feet long. The upper block is mounted upon four trucks in such a manner as to form a kind of car, and to be easily moved along the arm of the crane as circumstances may require. Motion is communicated by a rope which passes over a wheel on one side of the arm of the crane; this rope being pulled, motion is communicated to a system of cog-wheels, two of which act upon racks and propel the car. Care must be taken to give great strength to this machine, and to cause its motion to be easy on its pivot. When properly adjusted, a weight may be raised and transported from one point to another, anywhere within the limits of the circle described by the arm.

64. **Casting.** Iron guns have been cast by conducting the metal from the smelting furnace directly into the mould; but guns made in this way are not strong. The metal should be first cast into pigs, and afterward

remelted when the cannon is to be cast. When several furnaces are required to furnish the metal for a gun, they should be heated as nearly alike and at the same time, as possible, in order that the metal may be fused at the same time in all.

65. After the fusion takes place, opinions differ as to the interval that should be allowed to elapse before casting; one opinion is that the interval should depend upon the kind of iron in the furnaces, some kinds requiring, it is said, that the casting should be made as soon as possible after fusion, while, it is thought, other kinds are benefited by being exposed to heat after fusion. Mr. Robert Mallet, however, in his valuable work on the "Construction of Artillery" says, "The lower the temperature at which the fluid cast-iron is poured into the mould, and the more rapidly the mass can be cooled down to solidification, the closer will be the grain of the metal, the smaller the crystals, the fewer and least injurious the planes of weakness, and the greater the specific gravity of the casting." \* \* \* "The very lowest temperature at which the iron remains liquid enough fully to fill every cavity of the mould, without risk of defect, is that at which a large casting, such as a heavy gun, ought to be poured.

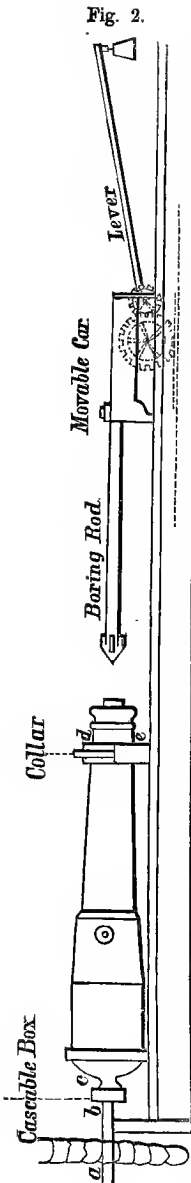
66. A deep pit is dug, at a convenient distance from the furnaces, for the reception of the mould. The flasks, containing the two parts of the mould, are firmly bolted together, and the mould lowered into the pit by the crane. It is then secured by braces in an upright position on the breech, and a floor of planks is laid over the mouth of the pit for the convenience of the founder. Channels are made in the sand to lead from

the different furnaces to a reservoir, which is formed near the mouth of the pit to receive the melted metal; between the reservoir and upper part of the mould a communication is established by a cast-iron gutter, coated with clay and black-lead.

The metal required for the casting having been placed in one or several furnaces, according to the quantity required, the openings are all closed and carefully luted with clay, with the exception of those through which the fuel is introduced. The fire is then kindled and urged as rapidly as possible until the fusion takes place, after which the plugs of loam, with which the furnaces have been stopped, are drilled out with pointed bars of iron, and the metal flows into the reservoir. When a sufficient quantity has collected, the gate of the reservoir is raised, and the metal flows into the side channel, through which it descends and enters the mould at the bottom; in the mean time the founder agitates the metal as it rises, with a long pine stick, to cause the scoria and other impurities to rise to the surface.

The entrance of the metal to the mould, at its bottom, is at an angle which gives a rotary motion to the liquid, the effect being to produce a depression in the centre, and a gravitation to it of the cinder or other earthy impurities which flow in with the metal, and, cooling there, are bored out when the gun is placed in the boring mill.

67. This *syphon-mode* of casting is resorted to for cannon in order to preserve the form of the mould. If the metal were conducted directly into the upper opening of the mould itself, its fall upon the sides and bottom would injure their forms. The casting is allowed



to remain undisturbed in order to cool, it is then taken from the pit and laid aside. A nine-inch gun remains in the pit five days, an eleven-inch gun remains ten days. Afterward the flasks are taken apart, the sand scraped off, slight protuberances of metal removed by a chisel, and the piece taken to the boring mill.

68. **Boring.** Cannon are bored by giving them a rotary motion upon their axis, and causing rods, armed with cutters, to press against the metal at the same time in the proper direction. The axis may be placed in a horizontal or vertical position according to the machinery employed, but the horizontal position is considered the best, on account of the greater ease with which the necessary stability may be given, and the greater simplicity of the machinery required.

• When a piece is to be bored it is placed with its axis horizontal, and sustained as represented in figure 2. The boring rod is mounted upon a car which moves upon two rails or slides, by the aid of a lever and weight acting upon cog-wheels which are fitted to each other, and made to act upon a rack below. The horizontal shaft, *a b*, receives a rotary motion from water or other power, and is furnished at its extremity with a box, *c*, fitted to receive

the square knob at the extremity of the cascable. The seat *e* rests upon the rails, and receives the collar, which is fitted to the neck of the piece. The collar is furnished with screws for the proper adjustment of the piece, and so fitted to the rest that it may revolve in its place with the piece.

69. **Cutting off Sinking Head.** When the piece has been properly adjusted, the first thing to be done is to cut off the sinking head. This is done by placing a cutter, called the head cutter, on the rails opposite the point where the cut is to be made, and pressing it against the revolving piece by the aid of a screw which is turned by a wrench. When the sinking head has been cut off, the cutter is removed.

70. **Boring.** The boring rod is fixed upon the car in such a manner that its axis shall be in the same horizontal line with the axis of the piece, and the car loaded with weights. The plan of boring, until the last few years, was as follows:—The extremity of the boring rod was armed with the first cutter, called the piercer, and pressed forward against the muzzle of the piece by applying weights to the extremity of the lever. When the piercer had penetrated to the bottom of the chamber, the car was drawn back, and the boring rod armed with the second cutter, or reamer, which was of the size required to give the full diameter to the bore. When the reamer had penetrated as far as the chamber, its place was supplied by the chamber cutter, which gave the necessary form and finish to that part of the bore.

71. In place of the piercer, a new cutter, invented by the late Captain Walbach of the U. S. Ordnance, is now generally adopted, which consists of a hollow cylinder

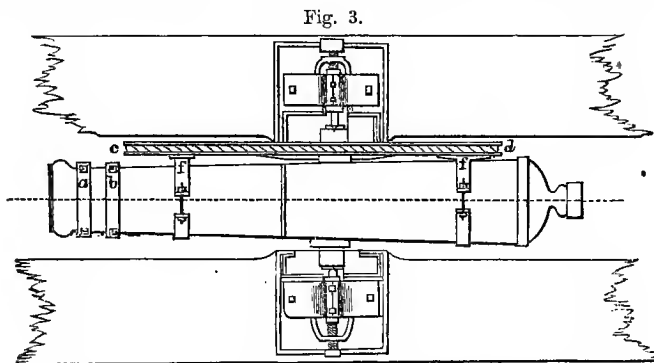
with cutters projecting from the base sufficiently to cut out a cylinder somewhat larger than the one to which the cutters are attached. This allows the cutter cylinder to pass down into the mouth of the piece, and the iron cuttings to pass out of the gun along the outer surface of the cylinder, which is broken off by wedging, after the cutter has gone down as far as it can (between two and three feet), and been withdrawn. The cutter is then run in again; and so on, until the boring is finished. The reamer and chamber cutter are used, as before, when this cutter has fulfilled its office.

72. **Casting on a Core.** The expense of boring may be avoided in part by casting the piece upon a core, and reaming it out afterward in such a manner as to give the necessary smoothness and diameter of the bore. The practical difficulties that interfered with the casting on a core, for many years, prevented any successful application of it; but this plan of casting has been carried out by Captain Rodman, of the U. S. Ordnance Department, whose plan of "hollow-casting" and the advantages of it will be dwelt on farther on.

73. **Turning.** In some countries it was customary to turn the whole of the exterior, for the purpose of giving a more smooth and elegant appearance than can be given in the mould; but it was believed that the strength of the piece was injured thereby. Practice, however, not having established this as a fact, all guns for the U. S. Navy are now turned upon the whole of the exterior. While the piece is being bored, cutting instruments are applied to the exterior, which is turned down to the proper size. That portion of the gun situated between the trunnions cannot be so removed; and is

taken off in a planing machine, in which the piece moves backward and forward under a cutter. Such portions of the surface as cannot be reached by these two machines are removed by the chisel.

74. The piece having been bored, and its exterior turned as already described, it is placed in a turning lathe, as represented in fig. 3, where the trunnions and



rim-bases are turned. The piece is secured in the turning lathe by two centres which are made to press against the extremities of the trunnions, and while a rotary motion is communicated to the gun about the axis of these trunnions, they are turned by cutters pressed against them. Clamps of iron, *a b*, are placed upon the chase to balance the piece, and the rotary motion is communicated by a wheel, *c d*, which is attached to the piece by the clamps, *f f*, and so adjusted as to be concentric with the trunnions. Care should be taken to make the trunnions of the same size, and perfectly cylindrical; their axes should be in the same right line perpendicular to the axis of the piece.

75. **Boring the Vent.** While in this lathe, the axis of the piece is placed at a proper angle with the hori-

zontal, a borer applied at the proper point, and the vent bored. It should enter near the bottom of the bore, and in a direction oblique to the axis of the piece, and in a plane at right angles to the trunnions. If a perpendicular be drawn to the axis, the deviation of the vent from that perpendicular, in entering, should be from nine to eleven degrees toward the breech. In bronze pieces, the vent is more easily injured than in those of iron, by the heat and gaseous matter produced by the combustion of gunpowder; thus it becomes necessary to have them *bouched*. The bouche, or vent-piece, is commonly made of pure copper, which has been well condensed by hammering when cold. It may be introduced when the piece is cast, in the part to be occupied by the vent, or inserted afterward in the form of a screw. The latter method is preferred on account of the greater ease and certainty with which a good joint may be formed between the copper and bronze, and that it may be removed and renewed if necessary.

**Vent-piece.** When the bouche is to be inserted, the cannon is placed horizontally upon a frame of wood, and a hole bored through the entire thickness of metal by a bit; other bits are afterward used to cut the thread of a screw in this hole, and to insert the vent-piece with the pressure required to make a good joint. When the vent-piece has been inserted, the end projecting into the interior of the gun is cut off, and the vent is bored through its centre by the usual means.

76. When the piece has been finished in other respects, and found by inspection and proof to be fitted for service, the square knob at the extremity of the cascade is removed by boring small holes in the metal and

splitting it off with wedges. This operation is reserved until after the inspection of the piece, in order to enable the founder to replace it in the boring mill to correct its form, or to cut it into pieces for recasting, if either should be necessary.

**77. Forging Wrought-Iron Cannon.** Few cannon have yet been made of wrought-iron, but the success obtained in this manufacture has been sufficient to show the practicability of making wrought-iron cannon of small calibre; the principal difficulty consists in forging a mass of iron of the proper size, so as to preserve its fibrous texture. When a piece is to be forged, a bundle of wrought-iron bars is made of the size required, and hooped together with bands of iron. The bundle, having been suspended from a crane in such a manner as to be easily moved from the forge to the hammer, is heated, welded, and hammered into the form required, as in the common method of forging. When the piece is forged in a single mass, it is bored and turned in the same manner as one of cast iron.

**78. Weakness of Wrought-Iron Cannon.** Wrought-iron cannon which are forged in this manner, if of large calibre, cannot be depended on as sound; this arises from the impossibility of condensing tons of wrought iron equally all through the mass. When the force of a blow, however great, is exerted upon the surface of a mass of metal, its effect is neutralized within a few inches of the surface, condensation takes place in inverse ratio from the point of impact, and thus the effect is limited. Another cause of the unsoundness of wrought-iron cannon of large calibre, is the long continued heat to which it is necessary to expose such large forgings.

79. **Steel for Cannon.** Mr. Greener (a gunmaker in England), writing on the subject of metal for cannon, says, "Steel, possessing, as it does, hardness to any desired extent, ductility in an equal degree, tenacity unrivalled, and all the other requisites, is destined to take the place of all other metals in the construction of artillery. This metal waits only to be tested, and the greater the extent to which the trial is carried, the more confident we are that it will answer every purpose." \* \* "The introduction of cast steel guns will be the most essential improvement in artillery; and an extensive series of experiments, extending over many years, during which time I have manufactured gun-barrels of steel alone, ought to give my opinion some weight on this subject."

80. **Nomenclature of Cannon.** The principal divisions or parts of a piece of naval ordnance may be enumerated and classed as follows:—See figs. 4, 5, 6, 7 and 8.

The **CASCABLE, A L**, is that part of the gun behind the base-ring, and in general terms, includes *the knob, the neck, and the base of the breech*; but as the forms, and consequently the nomenclature of the subdivisions of the cascable as well as of other parts of the gun vary in guns of different construction, these minor details are given in the diagrams and the explanation.

The **BASE OF THE BREECH, A J**, is a spherical or spheroidal segment in rear of the breech, between the base-ring and the fillet, or commencement of the neck.

The **BASE-RING, A**, is a projecting band of metal adjoining the base of the breech, and, with few exceptions, is connected with the body of the gun by a concave moulding, called the *curve of the base-ring*.

Fig. 4.

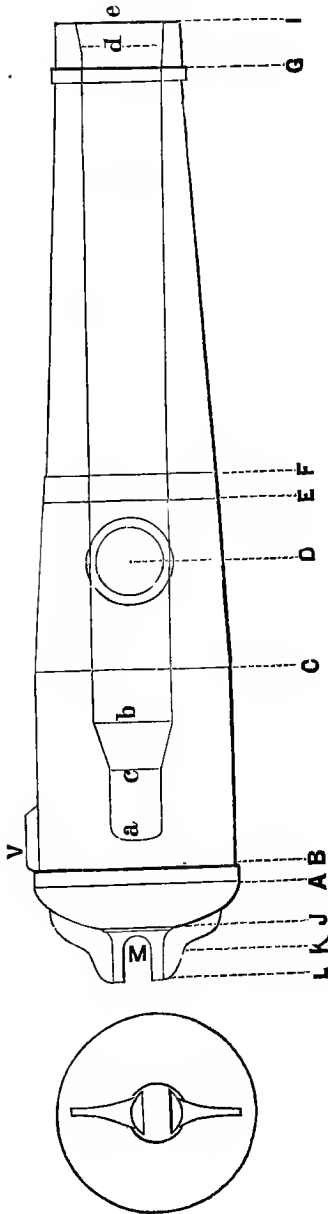


Fig. 5.

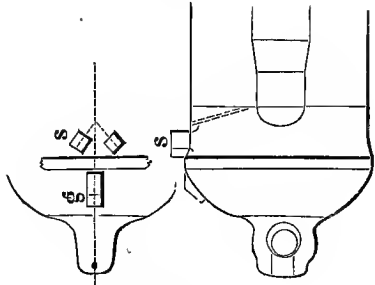


Fig. 6.

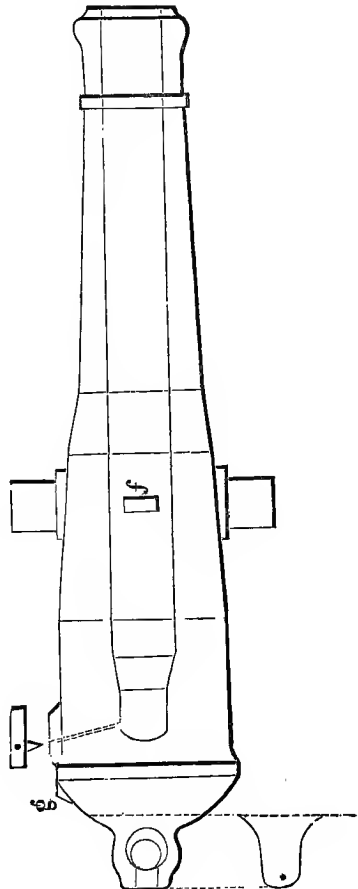
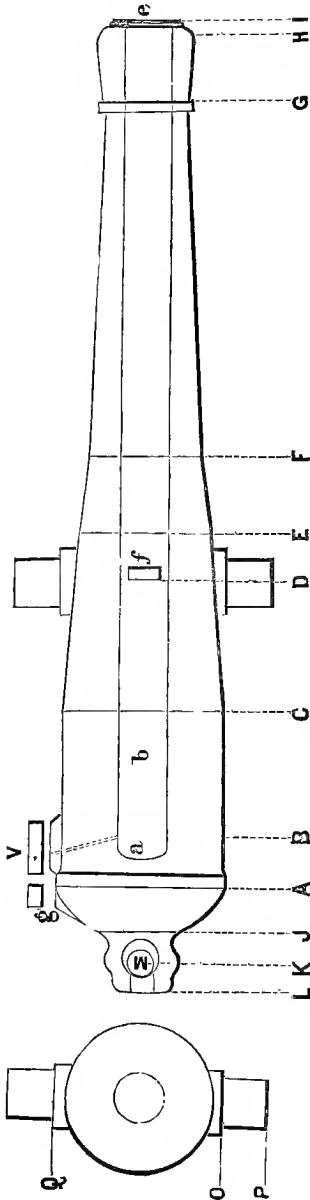


Fig. 7.



The BREECH, *a J*, is the mass of solid metal behind the bottom of the bore, extending to the fillet, or commencement of the neck.

In all U. S. navy guns of recent construction, there are two reinforces, designated respectively as the first and second reinforces.

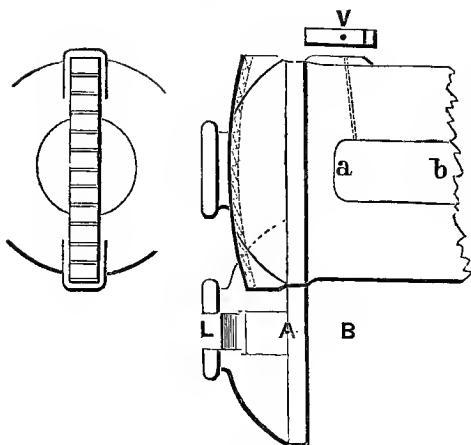
The FIRST REINFORCE, *B C*, is the cylindrical part of the gun in front of the base-ring, and is the thickest part of the body of the gun in front of that ring.

The SECOND REINFORCE, *C E*, is the truncated cone in front of the first reinforce, and extending to the chase, to which it is connected by a concave moulding, *E F*, called the *curve of the reinforce*.

The CHASE, *F G*, is the conical part of the gun in front of the second reinforce, and is bounded toward the muzzle by a ring, *G*, called the *chase-ring*.

The MUZZLE is that part of the gun comprised between the chase-ring, *G*, and the face

Fig. 8.



of the piece, I. In a few shell guns the form of the muzzle is cylindrical (fig. 4, G I), in which case the gun is called *straight muzzled*; since 1845, however, all guns, excepting the boat and field howitzers, have been

cast with *tulip-muzzles*, the parts of which are composed of the *neck*, the *swell*, the *fillet*, the *lip*, and the *face*.

The **NECK** is the narrowest part of the gun in front of the chase-ring. The **SWELL**, H, the largest part of the gun in front of the neck, and the **FILLET** and **LIP**, the cylindrical and concave mouldings which terminate the swell.

The **FACE**, e, is the terminating plane, perpendicular to the axis of the bore.

The **TRUNNIONS**, D, are cylinders, the axes of which are in a line perpendicular to the axis of the bore, and in the same plane with that axis.

The **RIM-BASES**, Q O (section at the trunnion), are short cylinders uniting the trunnions with the body of the gun. The ends of the rim-bases are planes perpendicular to the axis of the trunnions.

The **BORE** of the piece, a e, fig. 4, includes all the part bored out, viz.: the *cylinder*, b e, the *chamber*, a c, and

the conical or spherical surface,  $c b$ , connecting them. All shell guns in the U. S. Navy are chambered, also howitzers and mortars. The only solid shot gun in the navy which is chambered, is the 32-pounder of 27 cwt.; this gun, as well as the shell guns of 8-inch calibre, have their chambers cylindrical, and they are united with the large cylinder by a conical surface called the *slope*,  $c b$ ; the howitzers, for boat service, and the shell guns of 9-inch, 10-inch, and 11-inch, have conical chambers, joined to the cylinder of the bore by a portion of a spherical surface; these are called *gomer* chambers.

In shell guns of the models described by fig. 4, the bore at the mouth of the piece is bevelled conically; this part of the bore,  $d e$ , is then called the *flash rim*, or *cup*.

The BOTTOM OF THE BORE,  $a$ , is the interior termination of the bore. In the shell guns represented by fig. 4, it is a plane united with the sides, in profile, by an arc of a circle, the radius of which is one fourth of the diameter of the bore at the bottom.

The axis of the bore is coincident with the axis of the piece.

The LENGTH of the gun,  $A I$ , is the distance from the rear of the base-ring to the face of the muzzle. The rear of the base-ring is to be understood as the point from which all measures of length are to be taken.

The axis of the vent,  $V$ , is in a plane passing through the axis of the bore, perpendicularly to the axis of the trunnions.

The LOCK-PIECE is a block of metal at the outer opening of the vent, to which the lock is attached.

The BREECH SIGHT-MASS is a block of metal on the

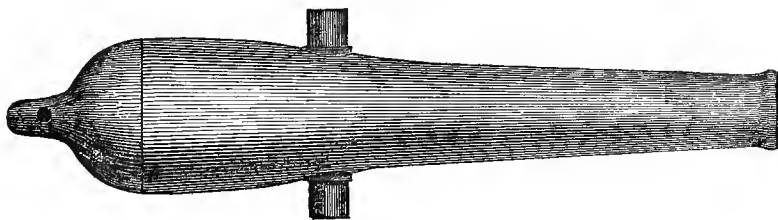
base of the breech, just in rear of the base-ring, and forms a support to the box in which the breech sight is made to slide.

The REINFORCE SIGHT-MASS is a block of metal on the second reinforce, just in front of the axis of the trunnions, and forms a base to which the reinforce sight is screwed.

The 64-pounder cannon of 105 cwt., has a ratchet (R, fig. 8) on the base of the breech, extending from the base-ring in a line through the neck and the knob, entirely across the base of the breech, and is divided into notches to receive the pawl and elevating lever by means of which the breech is supported and the elevation altered. This gun is gradually disappearing from the navy; the ratchet is still retained in the army.

A plane passing through the axis of the piece, at right angles to the axis of the trunnions, should intersect and divide equally the lock-piece, the breech, and reinforce sight-masses, and the ratchet, if there be one.

Fig. 9.



The form of the guns of the new pattern, as shown in fig. 9, commonly known as the Dahlgren guns, will, as far as those guns are concerned, require a modification of the nomenclature. In these guns every projection that can be dispensed with is suppressed, and the

exterior form is produced by a continuously curved line, no angular points being formed by suddenly changing the diameter at the different points along the piece. The additional strength derived from this form will be explained in the following chapter. The navy guns of this pattern are the 9-inch, 10-inch, and 11-inch shell guns.

81. **Inspection of Naval Ordnance.** The following instruments are used in the inspection of naval ordnance.

1. Mirrors, for reflecting the sun's rays into the bore.

2. Spirit-lamp and reflecting apparatus, for examining bores in cloudy weather.

3. Cylinder gauge for each calibre, turned to the exact minimum or true diameter of the bore. This cylinder is hollow, of wrought or cast iron, and its length is equal to its diameter. It has cross heads at right angles to each other, one with a smooth hole of the same diameter as the cylinder staff, the other tapped for the screw of the staff socket.

4. Star gauge, for measuring the diameter of the bore, and of the cylindrical part of the chamber.

5. Standard ring gauges, for adjusting the star gauge for use.

6. Measuring rod of white pine, marked with the proper length of the bore; lower end shaped to coincide with the form of the bottom of the bore.

7. Trunnion gauges, for measuring the diameters of the trunnions. The exterior diameter serves to verify that of the rim-bases.

8. Scribe compass, for laying off the distance of the centre of the trunnions from the base-ring.

9. Trunnion square, with movable branch and sliding

point, for ascertaining the position of the trunnions in relation to the axis of the bore.

10. Graduated steel wedge, for determining small differences of diameters.

11. Trunnion rule, for measuring the distances of the trunnions from the rear of the base-ring.

12. Exterior profile board, for verifying exterior lengths, having the lower edge adapted to the shape of the gun, and the upper one parallel to the axis of the bore. The true distances of the several parts from the rear of the base-ring are laid off on the upper edge, and marked in lines perpendicular to it on the sides of the profile.

13. A rammer head, shaped to the form of the bottom of the bore and furnished with a staff, for ascertaining the interior position of the vent. A profile board, similarly shaped, and with a groove on the edge to hold putty, may be used for the same purpose and to verify the curve of the bottom of the bore.

14. Profile blocks, for examining sight-masses and lock-piece.

15. Two cascable blocks, one for measuring the mouth, and the other the jaws of the cascable; the latter is cylindrical.

16. Set gauges, for measuring exterior diameters, used in turning, and provided by and at the foundry.

17. Vent gauges, two pieces of steel wire, .005 inch greater and less than the true diameter of the vent.

18. Vent searcher, a steel wire bent at the lower end, for searching the sides of the vent.

19. Semicircular protractor, for measuring inclination of vent.

20. A full set of instruments for loading and cleaning guns.

21. Ring gauges, one large, one small, and one mean, for inspecting the shot used in the proof.

22. Hydraulic press and apparatus for water-proof.

23. Searcher, with not less than six prongs, for detecting cavities in the bore.

24. Standard foot-rule, of metal, for verifying instruments.

25. Figure and letter stamps for marking guns.

26. A beam compass, to use with the standard scale for verifying measures.

27. Callipers, large and small, to measure diameters.

28. Iron square for setting callipers, graduated decimally, and having a stud at zero one tenth of an inch square.

82. **Inspection of Cannon.** For inspection the piece is placed on skids, for the purpose of being easily moved. It is examined closely on the exterior to see there are no cracks or flaws in the metal, whether it is finished as prescribed, and to judge, as far as practicable, of the quality of the metal. The gun must not be covered with paint, lacker, or any other composition, before it is inspected. Any attempt discovered to fill up flaws or cavities with plugs or cement, causes the rejection of the piece without further examination. The exterior diameters of the piece are then measured by means of the callipers; and the lengths of the different portions are also measured with the profile board.

A mirror is now held so as to reflect the sun's rays into the bore, which can be seen with great distinctness to the bottom. In case of the absence of the sun, a

spirit-lamp, on the end of a pole, is introduced and pushed to the bottom of the bore.

83. **The Searcher.** The searcher is then used for determining the presence of small cracks or flaws in the bore not visible to the eye. It is pushed slowly to the bottom of the bore and withdrawn, turning it at the same time. If one of the points catches, its distance from the muzzle is read from the staff, its position in the bore noted and marked on the exterior of the gun. The size and figure of the cavity are then determined by taking an impression of it in wax placed on the end of a hook.

84. **Cylinder Gauge.** The cylinder gauge is then introduced, which *must* pass to the bottom of the cylindrical part of the bore; if it does not go freely to the bottom the bore is too small, and there is no use in continuing the inspection; but, if it goes down, the bore may still be too large, and irregular in its dimensions.

85. **Star Gauge.** To ascertain this, a more complicated and delicate instrument is used, called the star gauge from the shape of its head, which is of brass, with four steel sockets, two movable and two stationary, for the *measuring points*. There are four measuring points for each calibre, and when two of these are screwed into the fixed sockets, the distance between their points is equal to the true diameter of the bore. The movable sockets rest against the inclined sides of a slider or wedge, whose sides incline 0.35 inch in a length of 2.2 inches, so that by pushing the slider the 35th part of this distance (about 0.06 inch), the distance between the two sockets or the measuring points, if screwed into their places, is increased .01 inch.

The slider is fastened to a square steel rod consisting

of three parts, which are screwed together according to the length of the bore to be measured. This rod passes through a brass tube which is also made in three parts, and to screw together. This tube is graduated into inches and quarter-inches, commencing at the plane of the measuring points, so as to indicate the distance of these from the muzzle of the gun.

The handle is of wood, attached to a brass cylinder or socket, through which the rod passes into the handle. The socket of the handle slips over the end of the brass tube made smaller for the purpose, and has a slit in it allowing the brass tube to be seen through. On the side of this slit a scale is constructed, to indicate the movement of the measuring points. Each joint of the long tube has a mark on it, to show the position for the zero of the scale when the instrument is properly adjusted for any particular calibre. In this position, the handle is fixed to the sliding rod by means of a screw clamp.

**Adjusting the Instrument.** A ring gauge, or ring of metal, for each calibre, is used for adjusting the instrument for use. The handle is loosened, the proper measuring points are screwed in, the ring gauge placed on them, and the slider pushed out until all the points touch the inner circumference. The zero of the scale is then made to coincide with the mark on the tube, and the handle clamped, when the instrument is ready for use.

A rest, in the form of a T, is placed in the mouth of the gun to keep the instrument in the axis of the piece.

Commencing at the muzzle, the diameter of the bore is measured at intervals of a calibre, as far as the trun-

nions. From that point to the seat of the shot, a diameter is measured at every inch, and for every quarter of an inch for the rest of the bore. No variations over 0.03 of an inch are allowed, and that must be in excess.

86. **Trunnion Square.** The trunnion square consists of a horizontal piece of iron with two perpendicular limbs projecting from it, one of them being movable on the horizontal piece, so as to admit of increasing or decreasing the distance between the limbs. The bottom edges of the limbs are in the same plane, parallel to the upper edge of the connecting piece, so that when the square is placed with its feet resting on the trunnions, the upper edge of the connecting piece is parallel to their axis. A point, sliding in a box, which is movable along the horizontal piece, projects down, and is fitted with a thumb-screw, to fasten it in any position. Each of the limbs has an iron plate projecting from its side, the lower edge of which (a half calibre above the lower edge of the limb) is perpendicular to the limb. It is placed on top of the trunnions, whilst the edges of the feet press against the side to determine whether the trunnions have the same axis perpendicular to that of the piece.

87. To find whether the axis of the trunnions is in the same plane with that of the piece, the feet are placed on the *top* of the trunnions, and their edges touch the rim-bases; the slider is pushed down till its point touches the surface of the gun at its highest point midway between the vertical limbs: secure the pointer at this place with the thumb-screw. Turn the gun over, and apply the square in the same way to the other side. If the feet now rest on the trunnions, and the pointer

touches the surface of the gun, the two axes are in the same plane. Should the point of the slider not touch, the axis of the trunnions is below that of the piece; but should the point touch and the feet not, the axis of the trunnions is above that of the piece. If the alignment of the trunnions be accurate, the edges of the feet will fit on them when applied to different parts of them; and if their axis is perpendicular to that of the piece, the edges of the feet will touch throughout the trunnions, while the iron perpendicular projection will rest on the top of them.

The size of the trunnions is determined by the trunnion gauge, which is an iron ring, which must fit closely on the trunnion, its outside circumference being of the same diameter as the rim-bases, and thus serving to verify them at the same time.

88. **Trunnion Rule.** The trunnion rule is a long, graduated rule, having on it a piece of metal in the shape of an L, one leg of which rests on the top of the trunnion, while the other rests against its side, and the distance of the trunnion from the base-ring is read off from the staff. Other external dimensions of the piece are measured by a wooden rule, or verified by means of the profile board.

89. **Length of Bore.** To measure the length of the bore, push the measuring rod to the bottom of the bore, apply a straight-edge to the face of the muzzle, and read off the length on the rod.

90. **Position of Vent.** A rammer-head, or simply a profile cut to fit the bottom of the bore, is used to determine the point at which the vent enters the bore, by thrusting in a priming wire, and marking where it

makes an impression on the wood. The position of the exterior orifice of the vent is also verified.

91. **Inclination of Vent.** The inclination of the vent with the axis of the bore is found by the semicircular protractor and vent gauge.

The vent gauges are two pieces of steel wire, greater and less than the true diameter of the vent by .005 of an inch. Variations, in excess, reaching to .025 of an inch are allowed.

The vent searcher is a hooked steel wire, about half the size of the vent, used to detect flaws or cracks.

92. The dimensions of lock-pieces and sight-masses must be verified by profiles and measurements; the opening of the mouth of the cascable and the diameter of the jaws are verified by the cascable blocks.

93. The dimensions and form of chambers are verified by means of forms cut from wood or metal.

94. Some few variations from the true dimensions may be allowed by the inspector, viz.:

	Inches.																				
In the diameter of the bore,	<table style="display: inline-table; border: none;"> <tr> <td style="font-size: 2em; vertical-align: middle;">{</td> <td style="padding-left: 5px;">more, . . . . .</td> <td style="text-align: right; vertical-align: bottom;">0.03</td> </tr> <tr> <td style="font-size: 2em; vertical-align: middle;">{</td> <td style="padding-left: 5px;">less, . . . . .</td> <td style="text-align: right; vertical-align: bottom;">0.00</td> </tr> </table>	{	more, . . . . .	0.03	{	less, . . . . .	0.00														
{	more, . . . . .	0.03																			
{	less, . . . . .	0.00																			
Exterior diameters,	<table style="display: inline-table; border: none;"> <tr> <td style="font-size: 2em; vertical-align: middle;">{</td> <td style="padding-left: 5px;">when turned,</td> <td style="font-size: 2em; vertical-align: middle;">}</td> <td style="padding-left: 5px;">more, . . . . .</td> <td style="text-align: right; vertical-align: bottom;">.05</td> </tr> <tr> <td style="font-size: 2em; vertical-align: middle;">{</td> <td style="padding-left: 5px;">when not turned,</td> <td style="font-size: 2em; vertical-align: middle;">}</td> <td style="padding-left: 5px;">less, . . . . .</td> <td style="text-align: right; vertical-align: bottom;">.05</td> </tr> <tr> <td style="font-size: 2em; vertical-align: middle;">{</td> <td style="padding-left: 5px;">when not turned,</td> <td style="font-size: 2em; vertical-align: middle;">}</td> <td style="padding-left: 5px;">more, . . . . .</td> <td style="text-align: right; vertical-align: bottom;">.20</td> </tr> <tr> <td style="font-size: 2em; vertical-align: middle;">{</td> <td style="padding-left: 5px;">when not turned,</td> <td style="font-size: 2em; vertical-align: middle;">}</td> <td style="padding-left: 5px;">less, . . . . .</td> <td style="text-align: right; vertical-align: bottom;">.05</td> </tr> </table>	{	when turned,	}	more, . . . . .	.05	{	when not turned,	}	less, . . . . .	.05	{	when not turned,	}	more, . . . . .	.20	{	when not turned,	}	less, . . . . .	.05
{	when turned,	}	more, . . . . .	.05																	
{	when not turned,	}	less, . . . . .	.05																	
{	when not turned,	}	more, . . . . .	.20																	
{	when not turned,	}	less, . . . . .	.05																	
In the length	<table style="display: inline-table; border: none;"> <tr> <td style="font-size: 2em; vertical-align: middle;">{</td> <td style="padding-left: 5px;">of the bore, more or less, . . . . .</td> <td style="text-align: right; vertical-align: bottom;">.20</td> </tr> <tr> <td style="font-size: 2em; vertical-align: middle;">{</td> <td style="padding-left: 5px;">from rear of base-ring to face of the muzzle, more or less, . . . . .</td> <td style="text-align: right; vertical-align: bottom;">.25</td> </tr> <tr> <td style="font-size: 2em; vertical-align: middle;">{</td> <td style="padding-left: 5px;">of the cascable, from rear of the base-ring to the end, more or less, . . . . .</td> <td style="text-align: right; vertical-align: bottom;">.20</td> </tr> <tr> <td style="font-size: 2em; vertical-align: middle;">{</td> <td style="padding-left: 5px;">of the reinforce, more or less, . . . . .</td> <td style="text-align: right; vertical-align: bottom;">.15</td> </tr> </table>	{	of the bore, more or less, . . . . .	.20	{	from rear of base-ring to face of the muzzle, more or less, . . . . .	.25	{	of the cascable, from rear of the base-ring to the end, more or less, . . . . .	.20	{	of the reinforce, more or less, . . . . .	.15								
{	of the bore, more or less, . . . . .	.20																			
{	from rear of base-ring to face of the muzzle, more or less, . . . . .	.25																			
{	of the cascable, from rear of the base-ring to the end, more or less, . . . . .	.20																			
{	of the reinforce, more or less, . . . . .	.15																			

	Inches.
From the rear of trunnions to rear of base-ring, more or less, . . . . .	.10
In the length of chamber, more or less, . . .	.10
In the position of the { above axis of the bore, axis of the trunnions, { below axis of the bore,	.00 .20
In the length of trunnions, more or less, . . .	.05
Diameter of trunnions, less, . . . . .	.05

In the same gun, no variations to be tolerated in the position of the trunnions, or in their alignment.

In the vent, { diameter, more, . . . . .	0.025
{ " less, . . . . .	.000
In lock-piece, any dimensions, more, .1, less, . .	.00
Variation of position of exterior orifice of vent, .	.05
"                  "                  interior          "          "	.20
Depth of cavities, {	.00
	.10
	.25
On trunnions, within one inch of rim-bases, . .	.10
On trunnions, elsewhere, . . . . .	.25
Enlargement or indentation of bore by proof, not to exceed, . . . . .	.02

If two or more cavities should be near each other on the exterior, the gun may be rejected, though the cavities should be of less depth than the allowance in the table.

95. **Powder Proof.** After inspection, cannon are subjected to the powder proof. The United States navy ordnance is tested with the following charges, viz.:

	Weight.	Rounds.	Powder.	Weight of shell.
xi-inch,	16,000 lbs.	10	15 lbs.	135 lbs.
x- "	12,000 "	10	12 $\frac{1}{2}$ "	100 "
ix- "	9,000 "	10	10 "	72 "
				Weight of shot.
viii- "	63 cwt.	10	9 "	64 "
viii- "	55 "	10	7 "	64 lbs.
64-pdr.,	106 "	10	16 "	64 "
32- "	61 "	10	10 "	32 "
32- "	57 "	10	9 "	32 "
32- "	51 "	10	8 "	32 "
32- "	46 "	10	7 "	32 "
32- "	42 "	10	6 "	32 "
32- "	33 "	10	4 $\frac{1}{2}$ "	32 "
32- "	27 "	10	4 "	32 "

Except in the cases of the first three guns enumerated above, which are of the new pattern, one junk wad is placed over the ball in proof.

If in any lot of guns, proved under the same contract, as many as one gun in every ten shall burst or crack, the whole may be rejected.

96. **Preliminary Proof.** In addition to this test, one gun is selected from each lot, and fired 1,000 times with the service charge; of course this gun is not supplied to the service.

Gunpowder for the proof of cannon, shall be of the best quality service powder, of not less than 1,600 feet initial velocity.

The shot used must be of full weight, and not less than the mean, nor above the high gauge.

After the powder proof, the searcher is to be introduced, and all parts of the bore thoroughly examined.

97. **Water Proof.** When the powder proof is finished, the bore should be cleaned and examined; the vent should then be stopped with a greased wooden plug, the muzzle raised, and the gun filled with water, to which pressure shall be applied to force it into any cavities that exist; the pressure to be applied in the water proof is two atmospheres, or thirty pounds to the square inch. The penetration of water in this proof, through the metal of the piece, in any place, will cause the rejection of the gun, and if, on examination, after the water proof, there shall be any defects indicated by weeping or dampness in the bore, the gun shall be rejected. The water proof is alone to be depended on to detect minute clusters of cavities in the bore, which, for this purpose, should be perfectly dry, and examined by sunlight. All inspections, consequently, should take place in fair weather, and when the temperature is above the freezing point.

98. In addition to the proofs enumerated above, samples of the iron are to be taken from the castings, and tested by an ingenious machine invented by Major Wade, in which the tenacity of the iron and its capacity to resist compression, a bursting force, and transverse and torsional strains, are all measured in pounds.

These samples are taken from the sinking head and core pieces; the first mentioned are cut from that end which was in contact with the muzzle of the piece; the axes of the samples are parallel with that of the casting, and their distance from the axis of the head is equal to the distance from the axis of the piece to the middle of the solid wall of the piece after it is bored out.

99. **Marking Cannon.** After proof, guns that have

passed inspection and proof shall be marked with the register number, the initials of the name of the foundry, and the weight in cwts. and parts, on the base-ring ; with the weight in pounds on the face of the muzzle ; with the calibre and date on the right trunnion, and with the letter P and inspector's initials on the left trunnion. The stamps used shall be one inch in height, except those on the muzzle, which shall be a half inch in height.

Cannon rejected for imperfections not deemed of a dangerous character, or which received them accidentally in the course of proof, will be marked thus  $\text{æ}$  near the foundry initial. If rejected for defects of metal, they will also be marked X. M.; if for dimensions only, which cannot be remedied, X. D.; if from water proof, X. W.; and if from powder proof, X. P. Such as are rejected for defects of a dangerous character, will have one trunnion broken off.

After proof, a coat of fish oil is to be given to the guns which pass inspection, in order to preserve them from rust.

## CHAPTER III.

## CANNON.

100. **Form of Cannon.** Cannon are in general of a truncated conical form, with a cylindrical opening along the axis to a certain depth. The strongest part surrounds the seat of the charge. The form is one adapted to the effects of powder, the gases of which act equally in all directions, and with a decreasing force as the projectile moves toward the mouth of the piece.

101. **Colonel Bomford's Plan for determining the Decrease in the Thickness of Metal.** The rate of this decrease, however, was comparatively unknown until the late Colonel Bomford, of the United States Ordnance Department, succeeded in demonstrating an approximate law by an ingenious device. Commencing near the muzzle of an ordinary piece, a hole was bored perpendicular to the axis. In this a pistol barrel was securely screwed, and a bullet inserted in it. The velocity of the bullet blown out by the discharge of the gun was measured, and similar experiments being made in succession at different points along the piece, a series of velocities increasing toward the breech was obtained, showing the relative force of the powder at the various points, and giving an indication of the requisite thickness of metal. The results of these experiments are relatively as follows, in decimal parts.

At one calibre in rear of the centre of the shot,	.9758
At the centre of the shot, . . . . .	1.0000
At one calibre in front of the shot, . . . . .	.8149
“ two calibres “ “ “ . . . . .	.6767
“ three “ “ “ “ . . . . .	.6163
“ four “ “ “ “ . . . . .	.5291
“ five “ “ “ “ . . . . .	.4393

These decimals show the relative strength necessary at different parts to resist explosion. Evidently the thickness of the metal should be greatest at the seat of the shot; usually the thickness at this part is equal to the diameter of the bore, or one calibre; in the heaviest guns it generally exceeds a calibre from a tenth to a fifth; in lighter guns it is sometimes below a calibre; and in carronades, is about four-fifths of a calibre. But the thickness, whatever it be at that part, is, when fixed upon, the unit from which the decrease toward the muzzle is estimated.

102. **Captain Rodman's Improvement on the Plan of Colonel Bomford.** Captain Rodman, of the U. S. Ordnance Department has suggested an improvement to Colonel Bomford's method of determining the thickness of metal, which consists in substituting for the pistol barrel and bullet, a piston having a punch at one end. This is put in the hole made in the gun, and a block of copper so placed, that as soon as the piston is acted on by the inflamed charge, the punch is forced into the surface of the copper, making a certain indentation, which is afterward compared with one made in the same block of copper by the same or a similar punch, in a machine where any amount of pressure can be given by the application of weights. This, although not an accurate process, the

forces applied in the two cases being so different in their nature, gives probably the nearest approximation yet obtained.

103. **Length of Gun.** After arranging thickness of metal with regard to sufficient strength of parts, length of gun is desirable only as far as about eighteen or twenty calibres, because experience has shown that eighteen calibres in length will burn the highest service charges used in long guns, and less length will burn those for medium guns; also that a short carronade will burn an appropriate charge for that gun. If a double fortified long gun (200 lbs. of metal to 1 lb. of shot) were much shorter than eighteen calibres, some of its charge of powder might be blown out unburned; and so of the medium gun (150 lbs. of metal to 1 lb. of shot), if reduced in length much below sixteen calibres. The bore, then, must have length enough for this purpose of burning the whole charge; beyond that, length is comparatively of no consequence as regards range. If, however, it be carried to an enormous extent, it will act to diminish the range. Under Charles V., an enormous piece was cast at Genoa, which was fifty-eight calibres long, and carried a ball thirty-six pounds in weight. It had less range than an ordinary twelve-pounder, and was about being recast, when the expedient was adopted of cutting off from the muzzle, first, eight calibres, then six, and then one; and the range was found to increase as the piece became shorter; which shows that, there is for each piece a maximum length which should not be exceeded. The reason of this seems to be, that for any increase of length over what is necessary to insure the total combustion of the powder before the ball leaves

the muzzle, a loss of velocity follows from the friction of the ball against the sides of the bore.

The labor of running a gun out to battery, and the limited distance that a gun can be allowed to recoil on board ship, are strong arguments against increasing the length; therefore the gun must be made long enough to burn the charge, and to project sufficiently from the port, but no longer. For this latter reason, viz.: sufficiency of projection, in order to clear the channels, lariards of the lower rigging, chain plates, &c., guns of smaller calibre are generally cast longer, and consequently heavier, in proportion, than guns of larger calibre.

104. **Thickness at the Breech.** The thickness of metal through, from the bottom of the bore, in the line of the axis of the gun, is of superior consequence; for if a gun be weak there, strength in other parts will not save it from explosion. That thickness, measured from the bottom of the bore to the rear of the base-ring, is equal to the thickness given to the metal at the seat of the shot. To this is added whatever strength arises from the form of the base of the breech.

Although the charge of a medium gun is less than that of a long gun, there is not a proportional decrease in the thickness of metal in the parts about the breech, because the quantity of powder actually igniting at that particular spot, may be nearly the same in a medium as in a long gun. In the former, less of the smaller charge, and in the latter, more of the larger charge, ignites along the bore, for which reason increased length is allowed, as has been shown.

105. **Exterior form of Cannon.** The bore of a gun

being cylindrical, and the thickness of metal decreasing from the breech to the muzzle, the form of a gun becomes that of a truncated cone; or rather, the surface of the piece presents several truncated cones, forming offsets, which have been until very recently finished off with mouldings. These cones are called *reinforces*. If the action of the gas alone was considered, it would be necessary to give but little thickness toward the muzzle. But the shocks of the projectiles glancing along the bore would soon injure the accuracy of fire of a piece so constructed, and a thickness, greater than is required merely to resist the force of the powder, is necessary. A cylindrical figure is given to the bore of all cannon, in order not to increase the loss of the elastic fluid already occasioned by the vent, and windage which it is necessary to give the projectile; and at the same time to diminish the violence of the shocks against the interior; thereby preserving the gun and making the fire more accurate.

106. **Recoil.** It is evident that in firing a gun the bottom of the bore is reacted upon by a force equal to that which drives before it the projectile and the unconsumed portion of the charge itself, for the inflammation of the charge is not instantaneous. We may then conclude that if the gun is of the same weight as the projectile, it will take up motion in a contrary direction with a velocity proportionally greater as the charge is heavier. This excess of velocity is due to the weight of the charge, the gases of which continue to react upon the bottom of the bore after the projectile has left the gun. The retrograde movement imparted to the gun by the effect of the charge is called the *recoil*, and should

be kept within certain limits, that the service of the gun may be convenient. Now we know, in mechanics, that the velocities are in inverse ratio to the masses; hence, if we have a gun 200 times heavier than the projectile, the recoil will not exceed the  $\frac{1}{200}$  of that which it would have been in the purely theoretical hypothesis, where the gun was supposed to be of the same weight as the projectile. Very light guns have a great recoil, and quickly destroy their carriages; very heavy guns have easy recoil, but are deprived of facility of manœuvring, a quality very essential to their use in service. There is a certain harmony then necessary to be preserved between the weight of a gun, the weight of its projectile, and its charge of powder.

107. **Effect of Recoil on Range.** It was thought that the recoil of a cannon must necessarily affect the velocity, and consequently the range, of the ball; but all experiments tending to elucidate this point go to show that with cannon the recoil is not apparent in its effect upon the velocity of the ball. Hutton says, referring to some experiments on this subject, "varying the weight of the gun produced no change in the velocity of the ball. The guns were suspended in the same manner as the pendulous block, and additional weights were attached to the pieces, so as to restrain the recoil; but although the arcs of the recoil were thus shortened, yet the velocity of the ball was not altered by it. The recoil was then entirely prevented, but the initial velocity of the ball remained the same."

It is evident that if the gun commence to recoil at the same moment that the shot commences to move from its seat, the recoil of the gun must exert some effect upon

the initial velocity of the shot, tending to diminish the range; but if the weight of the gun be so great in proportion to that of the shot as to prevent it from taking up motion until the shot is clear of the muzzle, no subsequent recoil can affect the range of the shot.

Suppose a shot fired from a 32-pounder of 57 cwt., with a full service charge, the ball will take up a velocity of 1,600 feet per second; now

$$V : v :: m : M$$

$$V = \frac{v m}{M}$$

or the velocity of recoil is equal to eight feet per second. Add to the weight of the gun the weight of the carriage, and the velocity of recoil will be still more reduced. Now add to this difference of velocities of gun and shot, the greater difficulty of overcoming the inertia of the cannon than that of the shot, and it is very possible that the shot will be clear of the muzzle before the cannon commences to obey the impulse which it has received. In this manner it is possible to explain the results as shown in Hutton's practice, but it is incorrect to suppose (what would be inferred from his statement) that the recoil does not, under any circumstances, affect the range of the projectile.

108. **Effect of Recoil on Range of Small Arms.** In the case of small arms, for example, it has been distinctly shown by experiments carried on at Springfield Armory, in 1855, by Lieutenant J. G. Benton, U. S. Army, with rifles, that there was a perceptible difference in the range of the balls when fired from the shoulder and from a fixed rest, due to the recoil that the piece was permitted to accomplish when fired from the shoulder. The reason

for this effect being perceptible in the small arm is (supposing the proportional weight of ball and piece to be the same, as in the case of a cannon), that its greater length prevents the ball from clearing the muzzle until after the piece obeys the impulse to recoil, and that the, relatively, want of *compressibility* of the metal in rear of the charge tends to communicate motion more rapidly to the piece. In the case of the cannon the large amount of metal in rear of the charge may be considered as composed of a number of layers, each of which receives its impulse in succession, and the cannon will not move until the impulse is communicated to the whole mass; but, in the case of the small arm, the amount of metal in the breech being comparatively small in proportion to the entire amount of metal in the piece, it yields quickly to the impulse of the force applied. Thus, if a cannon were constructed having the greater part of its weight in the fore part of the gun, thereby leaving a disproportionately small quantity of metal in rear of the charge, the want of compressibility of the metal at the breech would cause the gun to take up its motion of recoil rapidly, and might thus affect the velocity of the ball. Were this cannon constructed of an unusual proportional weight, this would lessen the distance to which the recoil would extend, but it would not tend to delay the commencement of the motion.

109. The consideration of the subject of compressibility leads to the detection of an error in Hutton's practice, inasmuch as he considered that by adding weights to the gun he produced the same effect as though he had concentrated that much more metal in the breech of the piece. This is manifestly an error,

since, from what has been said, it is evident that the gun with weights attached will take up motion more rapidly, than if the extra weight had been concentrated into the breech of the gun itself. The gun, with the weights attached, as soon as *its* mass is impressed with the impulse of the force applied, will take up motion *carrying the weights with it*, imparting to them a sudden motion; whereas were the extra weight concentrated in the breech of the gun itself, it would not take up motion until the whole mass was directly impressed with the impulse of the force.

It does not follow, however, that a correction of this error would alter the results in Hutton's practice, for, "when the recoil was entirely prevented, the initial velocity of the ball remained the same." It is probable then that the reason of the recoil of the cannon exercising no influence upon the initial velocity of the ball is, as has been stated, that the ball is clear of the muzzle before the commencement of the recoil, and the commencement of the recoil will be delayed in proportion to the compressibility of the metal in rear of the charge, which compressibility will depend upon the amount of metal situated at that part of the gun.

110. **Windage.** The diameter of the bore is always a little greater than that of the projectile, in order that the latter may enter easily, and that the service of the gun may never be interrupted by its jamming. The difference between the diameter of the projectile and that of the bore is called *windage*. Windage impairs the accuracy of fire, and occasions a great loss of gas, which diminishes the effect of the charge; it is also the principal cause of the deterioration of cannon.

111. Shot are cast with less diameter than the bores, in addition to the reasons mentioned before, so as to allow for their expansion, which, at a white heat, is one seventieth the diameter.

With the reduced windage of .1 inch, shot of a higher calibre than 42's will not, when at a white heat, enter the bore. Thus the highest diameter of a 42-pound ball when cool is 6.90 inches, and when at a white heat 6.998. The diameter of a 42-pounder bore, is 7.018 inches; consequently a 42-pound hot shot has only .02 inch windage. The shot of an eight-inch gun is, when cool, 7.90 inches in diameter; at a white heat it is 8.013 inches di-

Fig. 10.



ameter, or .013 greater than the diameter of its bore. The figure represents a shot in the bore of a gun, and the crescent-shaped space between the two circles indicates the windage ring.

112. **Chambers.** When a light gun is intended to throw heavy projectiles, we can only diminish the recoil by reducing the charges of powder; but as these charges occupy a small space, and would otherwise

Fig. 11.



Fig. 12.



be difficult to keep in their proper places, the bottom of the bore is contracted into the form of a chamber. The chamber may be cylindrical, figure 11, or conical, or gomer, figure 12.

A cylindrical chamber which is narrow and deep gives a greater range than one which is wide and shallow, but they sometimes break the shot, because they act upon a small segment of its surface; this inconveni-

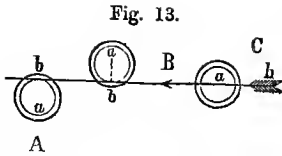
ence is not experienced with wide chambers, and particularly with the gomer chamber, where the action of the charge is exerted upon an entire hemisphere. The cylindrical chamber is the one used in the navy shell-guns of the old pattern and 32-pounder of 27 cwt.; the gomer chamber (called after its inventor) is in use in the navy howitzer and the shell guns of new pattern.

For small charges, the presence of a chamber is always advantageous, whatever may be the length of the gun, but the advantage is more marked as the gun is shorter. As the length of the gun is increased and the charge augmented, the influence of the chamber becomes less sensible, and the point at which its influence ceases to be felt is at a length of from ten to twelve calibres, and a charge of one-eighth of the weight of the projectile. In long guns firing with service charges, the presence of a chamber would diminish the velocity by lengthening the charge and diminishing the rapidity of its inflammation.

113. **Form of the Bottom of the Bore.** In nearly all guns the bottom of the bore or of the chamber is terminated by a plane which is connected with the adjacent surfaces by small arcs of a circle; this arrangement favors the cleansing of the bore and gives greater strength at the breech.

114. **Trunnions.** Cannons are mounted on their carriages by means of the trunnions, their common axis being perpendicular to that of the gun. The size of the trunnions is proportioned to the force of recoil; their position is fixed so as to diminish or favor the recoil of the carriage as circumstances may require.

For the carriage, at first, resisting the movement by virtue of its inertia, the piece, in the first instant, can



only have a tendency to turn on its trunnions; we see then that if the axis of the trunnions be below that, A, of the gun, the breech will bear down upon the carriage with a force proportional to the distance between the two axes, and that by this pressure a friction will be produced upon the deck which will diminish the recoil. On the contrary, if the axis of the trunnions be above the axis of the piece, B, the breech will have a tendency to rise and to leave the carriage, the pressure will be relieved from the carriage and the recoil will be favored; finally, the recoil will be transmitted directly to the trunnions, C, if their axis be at the same height as the axis of the gun, and there will be less disturbance of the flight of the projectile.

Trunnions are usually cast, in diameter and length, equal to a calibre. Formerly their axis was below the axis of the gun, and when so placed the gun was said to be *quarter-hung*; the object was to give an unobstructed side sight; it had also, as has been shown, the effect of diminishing the recoil, but the strain was too great on the carriages. The practice has been discontinued, and guns are now cast *centre-hung*, that is, with the axis of their trunnions passing through the axis of the bore.

115. **Preponderance.** The position of the trunnions with respect to the centre of gravity of the gun, exercises a certain influence upon the recoil. In guns that are fired at small elevations, the breech is heavier than the muzzle, the object of which disposition of the metal is to diminish the recoil, raise the muzzle of the gun,

and give it a fixed position ; otherwise the reaction, due to the elasticity of the carriage, would raise the breech and depress the muzzle, which would be inconvenient, On the contrary, in mortars, which are fired at great angles, the muzzle is heavier than the breech in order to facilitate the pointing. In these pieces, the trunnions are now placed entirely behind the piece, so that the chase of these rests upon their elevating quoins, which are placed in front. This excess of weight of one part of the gun over the other is called *preponderance* of the breech or muzzle. The measure of preponderance is the pressure sustained by the quoin or screw when the gun rests on its trunnions, the axis being horizontal, deducting friction. The usual preponderance is one-twentieth the weight of the gun.

116. **The Rim-bases.** The *rim-bases* serve to strengthen the trunnions, and prevent lateral motion on the carriage.

117. **The Vent.** The *vent* is the cylindrical channel which serves to communicate the fire to the charge. As the velocity of the gas produced by the combustion of the charge is very great, it escapes in a large quantity by this opening ; and as this escaping gas does not contribute to increase the velocity of the projectile, it follows that the effect of the charge will diminish with the increase in the size of the vent ; besides, if it be very large, it has a greater tendency to increase, than if it were smaller, on account of the increased velocity of the gas which escapes ; for these reasons, the vent has been fixed at dimensions which permit us to employ a priming wire of sufficient size, and tubes, while recent experiments show that the loss of force by the regulated vent is inappreciable.

118. **Influence of the Position of the Vent.** The influence of the position of the vent upon the velocity of the shot and the violence of recoil is appreciable. Experiments with charges of one-third (the weight of the ball), give results as follows: when the vent entered one-sixth the calibre from the bottom of the charge, it was found to give higher velocities to the ball than when entering at any other point; and when the vent entered at two-thirds the length of the cartridge from its bottom, the greatest recoil of the gun took place. These experiments also showed: 1st. That when the vent was made through the cascable in a line with the axis of the bore, the instantaneousness of ignition was so increased as to produce effects similar in violence to those arising from the explosion in a gun of detonating powder, viz.: to score the gun, break the shot, and impair its accuracy; 2d. That when the vent was set at an angle of  $30^\circ$  with the bore, effects of the same kind, but not to the same degree, were produced; and 3d. That when the vent was set at right angles with the axis of the bore, the parts of the charge ignited in succession, giving to the shot accelerating velocity, which produced no injury to the gun, and was favorable to the accuracy of the shot's flight.

With friction tubes it is objectionable to have any inclination to the vent, as it renders it easier to pull the tube out of the vent. The vents of some new guns in the army have, in consequence, been placed perpendicular to the axis.

119. **Phenomena in the Bore on the Combustion of the Charge.** In order to understand thoroughly the resistance of cannon, let us examine what takes place in the

bore when the piece is discharged. The fluids produced by the combustion of the charge, and a small quantity of unconsumed powder, rush at once between the upper side of the bore and the shot, which, by virtue of its inertia, resists the movement; the current presses it upon the lower side of the bore, and causes an indentation, which increases in depth at each discharge; this cavity is called a lodgement; the lodgement gives rise to a *burst* formed immediately in front of it by the displaced metal. The shot escaping from its lodgement, strikes the upper side of the bore, is reflected upon the lower side, and thus moves, ricocheting in the bore, and producing, by these repeated shocks, ordinarily to the number of three, indentations along the bore. These ballotings of the ball along the bore are sometimes violent enough to produce cracks and crevasses, to bend the chase of a bronze piece, and to render explosion imminent.

120. **Professor Treadwell on Lodgements.** In reference to lodgements, Professor Treadwell, of Harvard University, says, "I am inclined to attribute the indentation mostly, if not entirely, to the compression of the back hemisphere of the ball under the enormous blow of the explosion, producing a corresponding enlargement of the ball in its diameter transverse to the axis of the bore. The smith produces such a change of form in his bar of iron, at pleasure, by the blows of a sledge applied to its end. The operation is called *upsetting*. This enlargement must impress itself upon the part of the bore upon the under side upon which the shot rests, and is alone sufficient, in my mind, to account for the whole mischief.

"This view of the subject is confirmed by the form

of the lodgement, which consists, at first, of a single narrow impression, exactly corresponding to a very small segment of the ball, and not in the least in advance of the spot on which the ball rests before the discharge. Now this would be the exact form and place of an impression produced by a sudden enlargement of the ball, and an equally rapid recovery of its figure, which it would derive from its elasticity. But if the lodgement were produced by the pressure of the fluid upon its upper surface, it ought to form a long groove or channel, ceasing only with the diminished pressure of the fluid near the muzzle. Furthermore, the lodgement is greatest when a hard oakum wad is used behind the ball. Now, such a wad must prevent, in some degree at least, the escape of the fluid, and therefore diminish the downward pressure. But such a wad, driven hardest against the middle of the ball, in its rear, would act most advantageously to produce the lateral enlargement by *upsetting* it, as before described.

“Hard cast-iron guns do not exhibit this indentation in so great a degree,\* because, being unmalleable, they are incapable of a permanent change of form without fracture. With them, therefore, this pounding of the ball being repeated a few hundred times, shatters the walls of the gun, which, at length, gives way at once, and goes to pieces.

“It must be obvious, that if the lodgement be attributed to either or both of these causes, it may be prevented by a most simple and easy means. This is nothing more than providing that the ball shall, at the moment of the explosion of the powder, have no part in contact

\* The professor was experimenting with wrought-iron guns.

with the bore of the gun, but that the windage space shall be equally distributed about the whole circumference. This may be entirely secured by enveloping the ball in a bag made of felt, or of hard woollen cloth, having an additional patch upon its under side, to compensate for the weight of the ball. It would seem impossible that, in this condition, the ball, receiving the pressure of the powder equally distributed in the direction of the axis of the calibre, should touch the gun more than by a slight graze during its flight.

“It was during a course of experimental firing with a soft wrought-iron gun that I had an opportunity of observing the formation and increase of the lodgement; and here I was led to the experiment of placing the shot in a bag. My experiments were not sufficiently extended and varied to lead me to an assured conviction that the evil may be entirely prevented by this practice, but they were enough to lead me to a confident expectation of that result, as I could never detect the formation of any lodgement or any increase in one previously formed when the bag was used.”

121. **Injuries to Cannon.** Cannon are damaged more or less rapidly by use; in general the pieces of large calibre are those which most readily yield to the effect of a heavily sustained fire, which results from this, that the tenacity and the resistance of the metals are constant, whilst the intensity of the effort to destroy increases with the weight of the projectile and of the charge employed. This will be better understood from the following explanation.

122. **Increase of Strain due to Increase of Calibre.** In artillery practice, the restraining power which causes

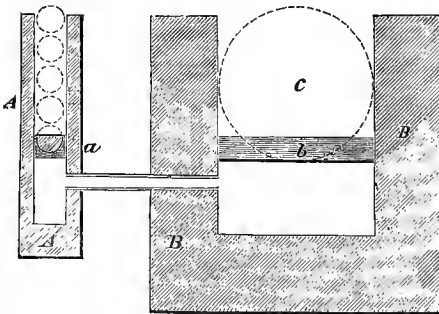
the powder to act against the walls of the cannon is derived principally from the inertia of the shot. Now, let us compare the difference of the force of powder as exerted upon a small and a large gun respectively. It is perfectly well known that if we have a pipe or hollow cylinder of say two inches in diameter with walls an inch thick, and if this cylinder will bear a pressure from within of 1,000 pounds per inch, another cylinder of the same material, of ten inches in diameter, will bear the same number of pounds to the inch if we increase the walls in the same proportion, or make them five inches thick. A cross section of these cylinders will present an area proportional to the squares of their diameters, and if the pressure be produced by the weight of plungers or pistons, as in the hydrostatic press, the weight required in the pistons will be as the squares of the diameters, or as four to one hundred.

Now carry this to two cannon of different calibres, and take an extreme case. Suppose the calibre of one to be two inches in diameter, and the other ten inches, and that the sides of each gun equal, in thickness, the diameter of its calibre. Then, to develop the same force, per inch, from the powder of each gun, the inertia of the balls should be as the squares of the diameters of the calibres respectively; that is, one should be twenty-five times as great as the other. But the balls, being one two, and the other ten inches in diameter, will weigh one pound and one hundred and twenty-five pounds respectively, the weights being as the cubes of the diameters (8 to 1,000 or 1 to 125). Hence each inch of powder in the large gun will be opposed by five times as much inertia as is found in the small gun.

This produces a state of things precisely similar to that of loading the small gun with five balls instead of one;\* and although the strain thrown upon the gun by five balls is by no means five times as great as that by one ball, there can be no doubt that the strain produced by different weights of ball is in a ratio as high as that of the cube roots of the respective weights. This would give, in the example before us, an increase of from one to 1.71, or the stress upon the walls of the ten-inch gun, would be seventy-one per cent. greater than upon those of the two-inch gun.

The foregoing statement and comparison, however, do not present the whole case; for they are made upon the supposition that the charge of powder, in each instance, is as the square of the diameter of the shot, or that the cartridges of the two and the ten-inch guns are of the same length. This, if we take the charge of the small gun at one-third of a pound, would give but eight and one-third pounds for the large, or one-fifteenth of the weight of the shot. The velocity obtained from this

Fig. 14.



\* The state of things here described will be comprehended by a glance at this figure. The two cylinders *A* and *B*, made in the proportions of one to five, will resist an equal hydrostatic pressure, and the weights or plungers *a* and *b*, with which they are loaded, will remain supported upon the water in equilibrium, if an open communication be made between them by the

pipe *d*. But if we load the larger one with the ball *c*, instead of *b*, we shall require five balls, as shown in the small cylinder *A*, to balance the pressure of *c*.

charge would produce neither range nor practical effect, and, to obtain these results, that is 1,600 feet per second, we must either increase the force through the whole length of the gun to five times that required for the small gun, or, the force remaining the same, we must provide for its acting through five times the space. By an increase of both the charge and the length of the bore, the result may be obtained, but this increases enormously the strain upon the gun.

123. It does not appear obvious, at a first view, how an increase in the charge should increase the tension of the fluid produced from it, if the cavity enclosing it be proportionably enlarged. If a steam pipe a foot long will sustain the pressure of a given quantity of steam of a given temperature, a pipe two feet long, of the same thickness and diameter, will sustain the pressure produced by a double weight of steam from the same boiler. Why then should the pressure upon a cannon be increased by a double length of cartridge? The difference seems to be this; with the steam the pressure is as in a closed cavity; with the powder, the tension depends upon the movement of the shot while the fluid is forming. Now, whether the charge be large or small, the motion of the shot commences while the pressure is the same in both cases, and before the charge is fully burned, and with the same velocity in both cases; but with the large charge, the fluid is formed faster than with the small, while the enlargement of the cavity by the movement of the shot is nearly the same in both cases. This destroys the proportion between the sizes of the two cavities, and the tension must increase faster, and become greater, from the larger charge. The law of this increase

cannot, from the complicate nature of the problem, be stated with any reliable exactness, but we may conclude from the increased velocity of the shot and many other effects, that the stress thrown upon the gun by different charges of powder, within ordinary limits, will not vary essentially from the square roots of those charges.

If, then, we increase, in the example under consideration, from a charge of  $8\frac{1}{2}$  pounds to one of 32 pounds, the stress upon the gun, being as the square roots of these numbers, is raised from 2.88 to 5.65, or from 1 to 1.96. Having already increased the stress upon the gun by the shot from 1 to 1.71, if we multiply these together, we have a total increase of from 1 to 3.35. That is to say, if, under the conditions stated, we load a gun of two inches calibre with 1 shot and one-third of a pound of powder, and a gun of ten inches calibre with one shot and thirty-two pounds of powder, the stress upon each square inch of the bores will be 3.35 times greater with the large than with the small gun; when, at the same time, if the walls of both have a thickness proportional to the diameters of the calibres in each, the large gun will be incapable of sustaining a greater pressure per inch than the small one. Even with a charge of twelve pounds of powder, the stress upon the large gun must be more than double that upon the small gun when charged with one-third the weight of its ball.

124. **Injuries to Bronze Cannon.** The high temperature and enormous tension of the gases give rise to other injuries in cannon. In bronze pieces, the tin is melted above the seat of the shot, which produces cavities whose surface is rough and furrowed; these are due to the fact

that the gases, obliged to escape through so confined a space as the windage-ring, are compressed, and develop an increase of heat susceptible of producing this effect. From the same cause cracks are formed, principally about the outer angle of the chambers of those cannon which have the cylindrical chamber.

125. **Drooping at the Muzzle.** Bronze pieces are subject to another injury resulting from quick firing, and consequent heating of the piece, viz.: "drooping at the muzzle." By the heat, the gun is expanded, the expansion extends to the whole length of the bore, so that the whole gun becomes lengthened by the "end-on" strain of its expanded interior. The co-efficient of expansion is so great, and the power of elastic recovery of form, so small, that in extreme cases the extension due to the end-on strain surpasses the elastic limit of recovery, and the gun becomes permanently lengthened. When in this state the firing is continued, and the metal becomes much heated throughout (though hottest in the inside) heat is carried off by convection from the lower side of the gun, by the ascending currents of the air around it, so fast, that the *upper side of the gun is relatively heated and expanded more than the lower side; and when the cross strain thus produced has bent the metal beyond the limit of its elastic recovery, the gun "droops at the muzzle,"* as it is called, an effect ascribed by some to the "softening of the metal by heat," a condition that could not happen until a temperature should have been attained at which no cartridge could be placed in the gun without its instantly exploding; in fact, more than a red heat. The "drooping" would be observed at the breech as well as at the muzzle were it not that the

very fine

breech is supported; were the piece supported at the two ends, instead of on the trunnions, the centre parts of the gun would rise and become arched or hogged.

126. **Injury to Cannon in Proof.** The injuries which have been mentioned, are common to all guns, but those of iron are subject to these effects in a less degree than bronze; iron guns, however, have the inconvenience of bursting unexpectedly with small charges. Formerly, when guns were subjected to great strain in the proof, they have been known to burst afterward with the service charge; this, very justly, has been charged to the effect of the heavy strain that the metal of the gun was subjected to at proof, a strain far greater than any that it would be called upon to endure in service; it is hence thought that many a good gun has been burst by subjecting it to an unfair strain in proof, and that all the guns that were formerly received were probably much more likely to burst, than if they had not been subjected to this strain. The present order for proof charges, as already stated, is a wise innovation on old usage. During a heavily sustained fire the vents of guns enlarge, they take an irregular and angular form, and it is worthy of note that, when a piece bursts, the plane of rupture nearly always passes through this orifice, and begins at it. The crack from the vent has been found to increase gradually up to a certain time before the bursting takes place, and has been known to be arrested by the boring of a new vent.

127. **Increase of the Durability of Bronze Cannon.** The durability of bronze cannon may be much increased by careful use, and by the precautions of increasing the length of the cartridge, or that of the sabot, or using a

wad over the cartridge in order to change the place of the shot; by wrapping the shot in woollen or other cloth, or in paper, so as to diminish the windage and the bounding of the shot in the bore.

**128. Indication of Effect of Service in Iron Cannon.** Iron cannon are more subject than bronze to the corrosion of the metal, by which the vent especially is rendered un-serviceable from enlargement. The principal cause of injury to iron cannon is the rusting of the metal, producing a roughness and enlargement of the bore, and an increase of any cavities or honey-combs which may exist in the metal. The service to which an iron cannon has been subjected may generally be determined by the condition of the vent and chamber, or bottom of the bore.

\* **129. Inspection of Vent.** In order to examine the condition of the vent, impressions are taken of the interior orifice with softened wax, and if they show that the vent is corroded in furrows, and enlarged considerably in diameter at its junction with the bore, a permanent impression is taken in lead to show the conical enlargement. The implements required for doing this are, a piece of copper wire, a lever about twice the length of the bore, a small button of lead judged to be of sufficient size to fill the vent at least one inch from the bore. This is to be pierced lengthwise to receive the wire.

To take the impression, shove the wire into the vent, let it pass along the bore and out at the muzzle; put it through the leaden button, and tie a knot at the end. Draw the wire back through the vent until the leaden button is felt to have taken firmly into the inner orifice. Apply the lever, making its end bear on the button, and

force it well in. This done, disengage the button by pushing in the wire.

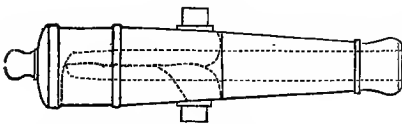
130. **Lifetime of Cannon.** The lifetime of a gun is generally estimated at from one thousand to twelve hundred rounds with service charge and one shot. Experience, however, proves that it is not only the great number of rounds fired which strains and destroys the gun, but that much influence is exerted by the high elevations at which a gun is fired in order to obtain range. A gun which, at  $6^{\circ}$  elevation, could stand without a strain two hundred rounds, would be likely, at an elevation of  $30^{\circ}$  to burst before fifty rounds were fired. The explanation seems sufficiently simple. A gun fired at  $6^{\circ}$  elevation recoils as the projectile is projected forward in proportion to its relative weight and friction; but when brought up to an elevation of  $30^{\circ}$  the gun is entirely out of the horizontal, and cannot recoil as it does at an elevation of  $6^{\circ}$ ; the force is now exerted downward, and the gun impinges on its support, on the deck of a ship, or on the solid earth of a battery, which is comparatively immovable; thus the force which displaced the gun in the first instance, is now exerted on the sides of the gun. The initial velocity of the projectile is also increased with the angle of projection, which is due to the increase of resistance to the expansion of the gases due to that fraction of the weight of the projectile which presses upon the charge; this increased resistance occasions a more tardy displacement of the projectile, and the force developed is increased, thus increasing the strain upon the gun.

131. **Strengthening Bands on Cannon.** The ancient method of forming guns from a number of pieces, and hoop-

ing them together after the fashion of a barrel, no doubt gave rise to the use of bands, mouldings and rings on the exterior, with an idea that they were strengthening the piece. Latterly these have been modified in order to produce a certain finish in the appearance of the piece, it being presumed that even if they did no good, they certainly could be productive of no harm. We will show that all these bands are causes of weakness to a gun.

132. **Causes of the Fractures in Cast-Iron Cannon.** In Mr. Robert Mallet's work "on the Construction of Artillery," many important facts bearing upon the subject are laid down; and among the rest is the general direction and course of the lines of fracture in cast-iron guns which have burst under fire. It is generally laid down that such guns burst through the vent, that being a weak or starting point for the action of the powder. From there the line of fracture passes along the axis to the front of the trunnions, where it turns off to the right or left, or both, leaving the rest

Fig. 15.



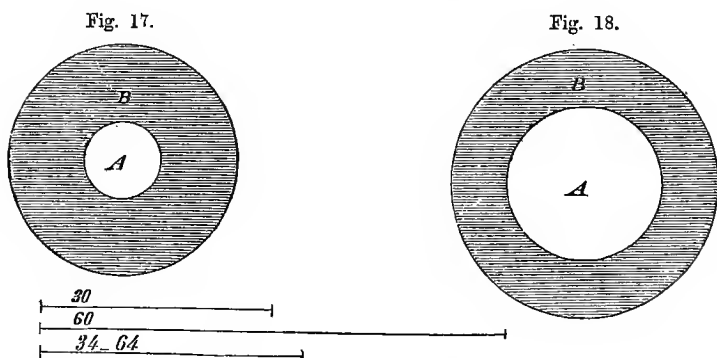
of the chase entire. That this is by no means always the case it is not necessary to state; but the heavy

dotted lines in figure 15 will show the most usual course for the fracture.

On examining a burst piece, the dividing plane in the direction of the axis will be found suddenly curved on one or other of the sides near the exterior of the gun, as shown in section in figure 16, plate I, showing that the fracture commenced at one side, *s*, opposite

the inflected portion, and spread from that, the parts dividing and turning from each other upon the point of inflection at *f*.

133. **Unequal Strain on the Exterior and Interior of a Cannon.** Fracture, then, appears to commence at the interior, rending the metal apart from within to without, a result agreeing with mathematical investigations, since the metal must yield first where the pressure per square inch is greatest upon its resisting unit of section, and this is on the interior. The following demonstration clearly shows this, from the consideration of the unequal strain brought upon the interior and exterior of a hollow cylinder, when distended. Suppose figure 17 to represent the cross section of a hollow cylinder, like a cannon; *A*, the bore 10 inches in diameter, *B*, the walls or body, 10 inches thick. Let this cylinder be distend-



ed by internal fluid pressure until the bore is 20 inches in diameter, as in figure 18. The external diameter will be increased only to 34.641 inches.

For in figure 17, the whole diameter is 30 inches and contains an area of  $30^2=900$  inches; from this take the area of the bore,  $10^2=100$  inches, and we have 800

inches in the area of the solid walls. Now after it is distended, the area of the bore becomes  $20^2=400$  circular inches, and as the walls contain the same area as before the distension, viz., 800, we have  $800+400=1200$  circular inches for the area of the whole section, and  $\sqrt{1200}=34.641$  for the external diameter. Before the distension the circumference of the bore was  $10 \times 3.141=31.41$ , and the external circumference of the body was  $30 \times 3.141=94.23$ . After the distension the circumference of the bore is  $20 \times 3.141=62.82$ , and the circumference of the outside solid is  $34.641 \times 3.141=108.81$ . Every inch, then, of the inner portion of the wall has been doubled in length by the distension, while the external circumference of the wall has been distended only in the ratio of 94.23 to 108.81, or from 1 to 1.155, less than one-seventh part. Hence, with a cylinder such as has been described, if of cast iron, the inner portion will be rent, or strained beyond its elastic power, at the instant that the outside portion is strained with only one-seventh part of the load that it is capable of bearing.

The case of distension taken in the above example is an extreme one, for the purpose of showing more clearly the physical condition of the problem, but this makes the ratio of the differences less than they are when the distension is kept within the bounds of practice with iron cylinders. If, in the preceding case, the distension of the bore be made, what it may be in practice just before fracture, one-thousandth part of the diameter, we shall find the external portion will be distended, practically, but one-ninth part as much as the internal portion of the solid, and, if we take an infinitely small part for the distension, exactly one-ninth.

If the cylinder be made thicker than in the example, the load borne by the outside will be still less. If it be twice as thick as the diameter of the bore, the outside portion will be strained with only one twenty-fifth part of the load it is capable of bearing when the inner portion is rent, and all the other parts must be rent in succession without any increase of the load. The law of the diminution in the power of resistance may be stated as follows: suppose such a cylinder to be made up of a great number of thin rings or hoops, placed one within another, then the resistance of these rings, compared one with another, to any distending force, will be inversely as the squares of their diameters.

134. **Effect of Re-entering Angles on Cannon.** The planes of fracture follow the track, with almost unerring precision of all *re-entering angles* on the exterior of the gun. Thus, although the longitudinal fracture often passes through the vent, it more frequently passes along the re-entering angle formed by the lock-piece with the gun; while the transverse fractures follow the edges of the base-ring and reinforce mouldings, and those near the trunnions, the re-entering angles formed by these with the body of the piece. These general directions of the fracture cannot be the result of accident; there must be some cause to place the fracture there in preference to other parts of the gun.

135. **Arrangement of the Crystals of Iron in Cooling.** Mr. Mallet says, "It is a law of the molecular aggregation of crystalline solids, that when their particles consolidate under the influence of heat in motion, their crystals arrange and group themselves with their principal axes in lines perpendicular to the cooling or heating surfaces

FIG. 16.

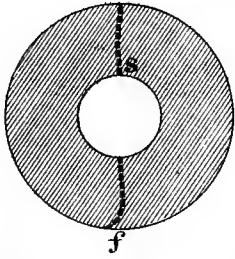


FIG. 19.

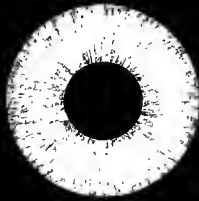


FIG. 20.

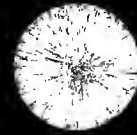


FIG. 21.



FIG. 23.



FIG. 24.

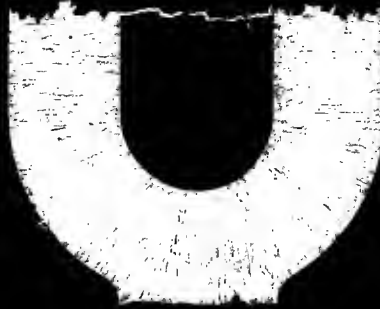


FIG. 22.



FIG. 28.

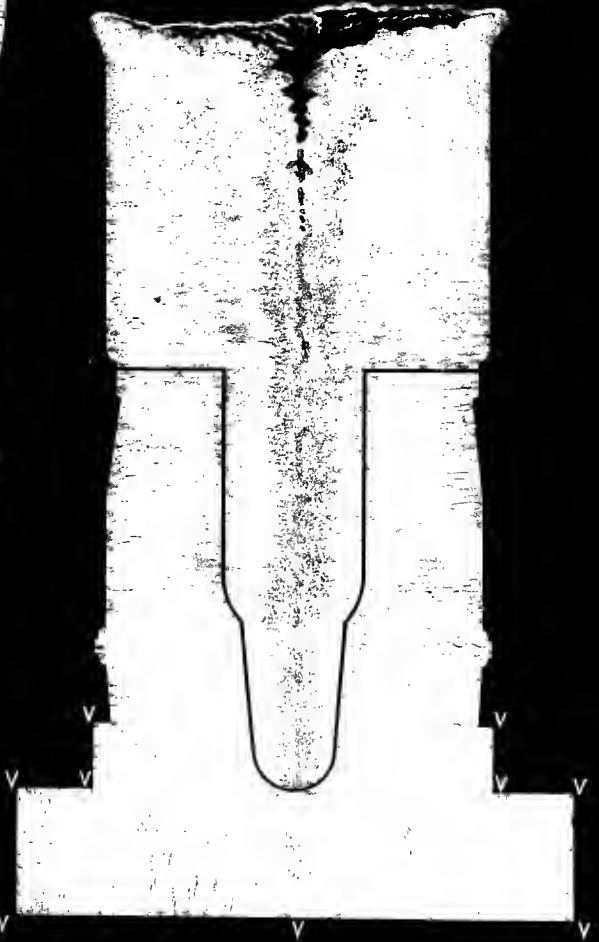


FIG. 27.



FIG. 25.

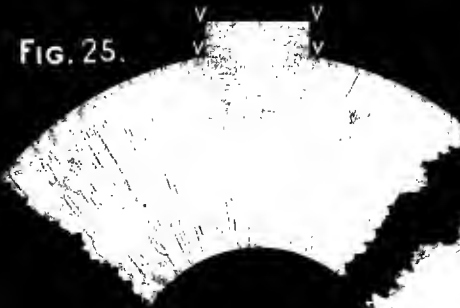
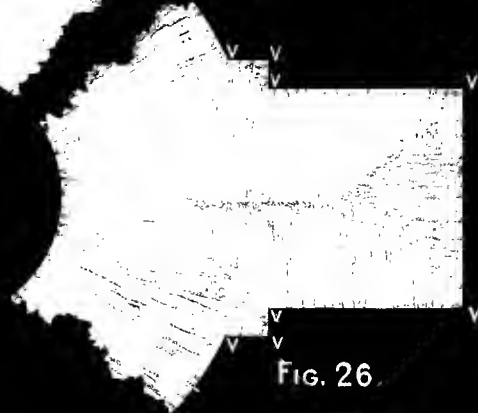


FIG. 26.





of the solid, that is, in the lines of direction of the heat-wave in motion, which is the direction of least pressure within the mass; and this is true whether in the case of heat *passing from* a previously fused solid in the act of cooling and crystallizing on consolidation, or of a solid not having a crystalline structure but capable of assuming one upon its temperature being sufficiently raised by heat applied to its external surfaces, and so *passing into* it."

If one of these crystalline bodies be cast in the form, say of an ingot, and "broken when cold, the principal axes of the crystals will always be found arranged in lines perpendicular to the bounding planes of the mass; that is to say, in the lines of direction in which the wave of heat has passed outward from the mass in the act of consolidation."

The same effect is produced by applying heat far below that of fusion to the surface of solids of similar substances. If a cylinder of lead, four or five inches long, and as many in diameter, be cast around a cylindrical bar of iron one and a half inches in diameter, and two or three feet long, the lead, cooling rapidly in contact with the cold iron, will have a perfectly homogeneous structure, entirely devoid of crystals. If the end of the iron bar be now placed in a furnace and heated redhot, and time be allowed for the heat to pass along the bar and into the lead until its temperature is raised to about 550° Fahr., it will, when struck several blows with a hammer, all fall to pieces, and show a complete crystalline structure with the principal axes of the crystals radiating from the centre of the cylinder. See figure 19, plate I.

If a flat, thick piece of malleable or rolled zinc which, if not homogeneous, has its fibres lying in the plane of the plate, be laid flat upon a cast-iron plate, heated to within a few degrees of the melting point of the zinc, it very soon becomes crystalline, the axes of the crystals being now all arranged perpendicular to the sides of the plate.

136. Any one who has ever remarked upon the formation and melting of ice, will have seen the same principles exemplified on a grander scale. The little sharp crystals, as they form, are all lying flat upon the surface of the water; when, in the spring, the ice becomes rotten from the heat it has absorbed from the water beneath and the air on top, these crystals will all be found arranged vertically, and are easily pushed through by the weight of the foot or a stick. Large floating cakes of ice have been known to disappear on being struck by a vessel or on striking the shore, called sometimes the sinking of the ice. The shock destroys the little cohesion remaining between the crystals, and the whole mass falls apart.

137. Cast iron is one of the substances which, in cooling, obeys more or less perfectly this law, so that it may be laid down as a fact that the crystals of an iron casting arrange themselves perpendicularly to the exterior surfaces. The crystals being small, this arrangement is not very apparent to the eye. Their development depends upon the character of the iron and the size of the casting, the largest casting presenting the largest and coarsest aggregation of crystals, but not the most regular arrangement of them, which depends upon the rate at which the mass is cooled, and the regularity with

which heat has been carried off by conduction from its surfaces to the surrounding mould. Hence in casting by what is called the *chilling* process, where the mould is cold thick iron, whose high conducting power carries off the heat rapidly, the most complete crystalline structure occurs perpendicular to the chilled surface.

The arrangement of the crystals in casting of different forms, can be better seen by referring to the figures which represent sections of the different forms. Figure 20, plate I., is a section of a round bar where the crystals all radiate from the centre.

In the square bar figure 21, plate I., they are arranged perpendicular to the four sides, and hence in the diagonals of the square, the terminal planes of the crystals abut or interlock; along these lines the crystallization is always confused and irregular, forming *planes of weakness*, along which the cohesion of the metal is less than in any other part.

In the flat bar, figure 22, plate I., the crystals are arranged as in the square, with an extension in one direction.

In figure 19 is shown the arrangement in a hollow cylinder.

Figure 23, plate I., represents a portion of the closed end of the cylinder of an hydraulic press which broke under a great pressure, the end of the cylinder having broken out from the sides in the form of a flat frustrum of a cone, showing that the planes where the crystals perpendicular to the different surfaces join confusedly together, are planes of weakness, along which, as has been said before, the cohesion of the metal is less than in any other part. In consequence of the failure of this

cylinder, the form was changed to that represented in figure 24, plate I., where the direction of the crystals, changing gradually, formed no planes of weakness; and this stood the pressure without breaking. The similarity of these forms to the breeches of guns will be readily recognized.

Figures 25 and 26, plate I., are sections of different re-entering angles found on guns as now cast; and show the planes of weakness resulting therefrom. Figure 25 is through the lock-piece; figure 26 is through a trunnion; and figure 27, plate I., through a reinforce band, or chase ring; and all show planes of weakness to exist exactly where the planes of fracture pass in burst guns, as will be seen by referring back to figure 15. "The conclusion, therefore, seems inevitable, that however incapable the unaided eye may be to discern any difference in the crystalline arrangement of one part of the gun more than of another, such planes of weakness do exist in the positions and from the causes here pointed out."

138. It follows, then, that in casting our guns, all *sudden* changes in the direction of the surface should be avoided, that all unnecessary projections, such as the base ring and chase ring, reinforce bands, mouldings, muzzle bands, &c., should be dispensed with, and that the piece when finished should present as unbroken a surface as possible, and with a rounding (if possible spherical) breech, so as to avoid the great planes of weakness that were formed at this place in guns of old pattern. With such a form there will be no use in adding more metal than is now supplied; the defect increases with the size of the casting, and the strength

gained is not enough to compensate for the increased weight.

139. It may be objected that these bands, ornaments, &c., are not cast on the piece, but turned from it after the casting is cool, and can therefore have no effect upon the arrangement of the crystal. Not certainly *at first*, but it must be remembered that the law quoted applies as well to the body when receiving heat as when giving it off; and that after a gun becomes heated by repeated firing, the heat, having passed through from the inner to the outer surface, has produced its effect upon the crystals, and arranged them normal to the surfaces by which the heat goes out. Hence old guns which have been a great deal used, take a crystalline form, and are liable to fall to pieces at any time from the shock of gunpowder. This is by far the most satisfactory way of accounting for the weakness and bursting of old guns. Cast-iron guns have not the tenacity of bronze, which commence splitting long before they burst; but the change gradually takes place in the *metal*, and when, after long use, the shock becomes too great to be borne, the mass flies apart like a huge cake of ice in the spring, which, in the winter, before its crystalline structure was upset, was capable of supporting thousands of tons.

140. **Effect of Irregularities on the Surface of Cannon on Vibration.** There is another evil effect resulting from protuberances or projections on the exterior of a gun which is of great importance. Wherever these irregularities exist in the substance of the metal, there the *waves of vibration* are interrupted, and the weak point then becomes fractured. The science of spring-making demonstrates the truth of this statement. Leave on a

coach spring an abutment of metal (like an old reinforce ring), and a few motions will be sufficient to break it, however well the spring may be constructed in every other part. The rigidity of this protuberance, by interrupting the waves of vibration, causes additional vibration in the adjacent and more yielding part, and thus produces fracture. The same thing occurs in all ill-constructed artillery; where the vibrations are checked, there is always danger of some weaker part giving way.

141. **Effect of Unequal Rapidity in Cooling.** In casting guns, some parts which are smaller than others, will cool the fastest, forming strains in the piece which are liable to act injuriously. Thus, for instance, the neck of a piece will cool much before the body, thus cutting off the supply of liquid metal from the sinking head, and a vacant space or cellular portion of metal is left in the interior of the gun, having very little tenacity. On this account the models for guns are not now made so sloping toward the muzzle, but approach more nearly a cylinder in shape, and the gun is afterward turned down by machinery. This is found to render the piece very much stronger.

142. **Effect of Unequal Shrinking in the Casting.** A great source of weakness in cast-iron guns arises from the unequal shrinking of the casting. The heat is conducted away from the outside; the outside, cooling, solidifies or *sets*, while the inside remains in a fluid state. As the inside cools, its tendency is to contract, but the cooled outer shell encloses more space than is required for the enclosed metal when shrinking in cooling. This destroys the equilibrium among the particles, leaving them *upon the stretch*, or in a state exactly opposite to

that in which, to give the greatest strength, they ought to be in; leaving, in fact, along the axis a line of weakness where the metal is soft, porous and with coarse and separated crystals, leaving, in spite of the constant feed of liquid metal through the sinking head, actual cavities in the centre of the casting.

Fortunately in pieces of artillery, this portion is nearly all bored out; but where the boring does not extend well back to the breech, a portion of this soft spongy mass remains, forming the bottom of the bore. This is more especially the case in very large mortars, and the defect increases, of course, as the mass of the casting becomes larger. Figure 28 plate I., represents a large mortar with the sinking head still on, and the bore marked out. The weak point is evidently at the bottom of the chamber. A remarkable exemplification of this weakness was exhibited in the English thirteen-inch mortars used in the bombardment of Sweaborg, during the last war with Russia. All of these mortars burst after an average of one hundred and twenty rounds. They split into two almost equal halves, in a plane passing through the axis and vent, and exhibited no defect or injury except just at the bottom of the chamber, where "a small irregular, cavity was found, with jagged sides and bottom, as though burrowed into by some corroding agent."

143. **Casting on a Core, or Hollow-Casting.** To avoid these defects, it has been proposed to cast guns, more particularly heavy mortars, hollow, or on a core, and in this way to have in cooling a hollow cylinder, which we have shown to be the strongest form. The piece may be cast on a core placed in the centre of the mould, just as a shell is cast.

Captain Rodman, of the Ordnance Department of the U. S. Army, has for some time been making experiments on a plan of his for casting guns hollow, and has succeeded in casting a gun of the enormous calibre of fifteen inches, which is probably the strongest iron gun ever cast of that calibre.

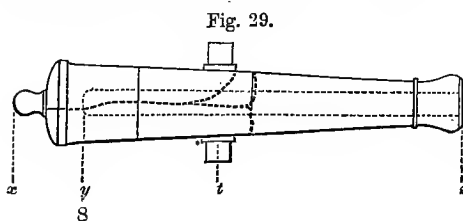
144. **Rodman's Plan of Hollow-Casting.** His manner of casting may be briefly described, as follows: a core is formed on a water-tight cast-iron tube, closed at the lower end. By means of an interior tube in the centre of the other, and open at the lower end, a stream of water is conducted to the bottom of the larger tube, and rising through the circular space between the two, flows out at the top. A fire is built around the jacket at the bottom of the casting pit, and the mould kept at nearly red heat. In casting an eight-inch columbiad, twenty-five hours after casting, the core was withdrawn, and the flow of water continued through the space left by it for forty hours longer. The amount of water used was about fifty times the weight of the casting, and the heat imparted to the water, and carried off by it, was equal to  $60^{\circ}$  on the whole quantity used. For larger pieces, the amount of water and time of cooling are greater.

All the guns cast in this way present a marked superiority in endurance over those cast solid in the ordinary way; and the eight-inch columbiad, mentioned above, sustained fifteen hundred rounds, including proof charges, without bursting, whilst another of the same calibre, cast solid, from the same metal, at the same time, and under precisely the same circumstances, failed at the seventy-third round.

It is evident how the metal of a piece cast in this manner avoids the defects pointed out as existing in a piece cast solid and allowed to cool in the old way; the merit of Captain Rodman's invention evidently consists in retarding the cooling of the outside by the application of heat, and hastening that of the inside by the application of cold, thus rendering the cooling of the whole mass more uniform, and preventing the formation of successive layers of different temperatures; or, if they are formed at all, making them commence on the interior, by which the strain is reversed, and actually made to add to the strength of the piece, the inner layer *setting* first, and each successive outer layer shrinking, in cooling, and *setting* around the layer inside of it.

145. **Effect of the Trunnions.** Another great cause of the want of strength in guns as at present formed, is the position of the trunnions, as regards the point to which the recoil of the gun is transmitted. The existence of these trunnions, by forming great re-entering angles on the surface of the gun, is of itself a great cause of weakness, as has already been explained; but their position on all pieces except mortars, has a weakening effect in a different way, which will now be explained.

The force exerted to produce recoil, acting as a pressure against the interior of the breech, is propagated as a force tending to stretch the metal of the gun from the section  $y$  (fig. 29), in line of the axis toward the



muzzle  $z$ ; the rate of propagation being extremely rapid, so much so that, to the senses, the

whole gun recoils together and as one mass, and at the same instant; yet in reality the first effect of the recoil is to elongate the gun, pushing out the breech part like one end of a spiral spring; the elongation traversing the whole length of the gun, and arriving at the muzzle, leaves it at its original length, assuming the elongation to have been far within the elastic limits of the metal. In its rapid progress, however, it has produced a strain in succession in the line of the axis upon every part of the gun.

146. If the gun have no trunnions, but, resting without friction, abut firmly against a fixed obstacle against the breech at  $x$ , then the segment in rear of the cartridge will be compressed by a force equal to the whole recoil in the direction  $y x$ , while the remaining parts of the gun will be extended by a force in the direction  $y z$ , which, at the transverse section  $y$  is equal to the recoil, and at the muzzle is equal to zero.

If the gun be fixed rigidly on trunnions placed in the usual position at  $t$ , the strain tending to tear or break them off is equal to the whole work done by the recoil.

Could, therefore, a convenient method be adopted for supporting guns upon their carriages without the use of trunnions, the recoil being received by a support entirely in rear of the piece, the trunnions could be dispensed with, and the gun very much strengthened in two ways. Muskets and other small arms are therefore arranged in the way best suited to their strength, and they can therefore be made much lighter than would otherwise be safe. The cannon of the ancients possessed this element of strength, for they were without trun-

nions, and transmitted the recoil to supports placed behind. In some of the new rifled guns, supplied to the navy, an attempt has been made by Captain Dahlgren to apply this principle by strapping on the trunnions.

147. **Effect of Age on Endurance.** In connection with this subject of endurance, an important fact was noticed in making some experiments in 1852. It was found that the length of time that a piece had been cast had a very great influence upon its endurance.

Three eight-inch columbiads of the same form and dimensions, and cast in the same way, were tried. One of them had been cast only a few days, the other two were six years old, and of metal of inferior strength to the first. The one tested immediately after casting failed at the seventy-second round; of the other two, the weaker failed at the eight-hundredth round, and the other sustained two thousand five hundred and eighty-two fires without yielding.

148. This apparent anomaly seems to be satisfactorily explained by the supposition that the strain which has been referred to as existing in the gun when cast is limited in duration, and that, like many other substances, iron possesses the property of accommodating itself to an unnatural position, and finally of adopting this as its natural one, and of actually being as strong or even stronger in that than in the original state; just as a barrel-hoop after becoming used to the new direction, will not only not return, when released, to the old, but require force to bring it back, showing that the fibres possess the power of accommodating themselves in accordance with the solicitation of external forces. There is nothing in the character of iron which precludes

this idea of a new arrangement of the fibres; on the contrary, as has been shown, it does take place under certain circumstances.

It would therefore seem to be advisable and of benefit to the strength of ordnance, that it should be allowed to remain for a certain length of time undisturbed after casting and before being tested; and, most probably, the longer this period the greater becomes the strength of the pieces.

149. **To render Cannon unserviceable.** In order to render guns unserviceable, drive into the vent a jagged and hardened steel spike with a soft point, or a nail without a head; break it off flush with the outer surface, and clinch the point inside by means of the rammer. Wedge a shot in the bottom of the bore by wrapping it with felt, or by means of iron wedges, using the rammer or a bar of iron to drive them in; a wooden wedge would be easily burned by means of a charcoal fire lighted with the aid of a bellows. Cause shells to burst in the bore of bronze guns, or fire broken shot from them with high charges. Fill a piece with sand over the charge to burst it. Fire one piece against another. Light a fire under the chase of a bronze gun, and strike on it with a sledge to bend it. Break off the trunnions of iron guns, or burst them by firing them with heavy charges and full of shot, at a high elevation.

When guns are to be spiked temporarily, and are likely to be retaken, a *spring spike* is used, having a shoulder to prevent its being too easily extracted.

150. **Unspike a Cannon.** When wishing to unspike a piece, if the spike be not screwed in or clinched, and the bore is not impeded, put in a charge of powder of

one-third the weight of the shot, and ram junk wads over it with a handspike, laying on the bottom of the bore a strip of wood with a groove on the under side containing a strand of quick match by which fire is communicated to the charge; if a bronze gun, take out some of the metal at the upper orifice of the vent, and pour sulphuric acid into the groove for some hours before firing. If this method, several times repeated, be not successful, unscrew the vent piece, if it be a bronze gun, and if an iron one, drill out the spike or drill a new vent.

151. **Preservation of Cannon.** In order to preserve guns which are not in service, they should be carefully placed on ranges of masonry, capped with iron skids or bolts. These must be so high as to admit of the guns being rolled upon them without their trunnions touching the ground, and so as to prevent the earth from being beaten against their muzzles by heavy rains. The surface over which guns are stowed should be clear of all vegetation. Before being stowed the guns should be thoroughly cleansed from all rust, and be lackered internally and externally. The vents, which should be upward, should be stopped with plugs made of soft wood, or oakum dipped in tallow; all screw holes should be plugged in the same manner as the vents. No tom-pions should be put into the guns, for moisture will enter the bore, no matter what precautions may be used, and the best manner for it to dry up is by leaving it exposed to the circulation of the atmosphere.

## CHAPTER IV.

## GUN-CARRIAGES.

152. **Conditions required of a Gun-Carriage.** Cannon are mounted upon carriages of various forms. Before proceeding to describe them, we will explain the conditions which they ought to satisfy to be of service at sea. Certain of these conditions refer to their facility of manœuvring under fire; others have reference to facility of transportation, whilst stability and simplicity of construction are of paramount importance.

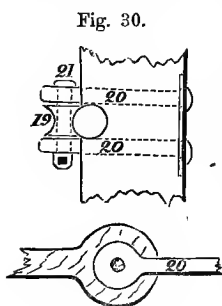
153. **Necessity of Recoil.** Under fire the carriage must yield to the force of recoil; it would quickly be destroyed, whatever might be its solidity, if it maintained a fixed position. At Gibraltar some attempts have been made to mount guns in the rock itself, but the recoil either broke the trunnions, or the rock gave way. The carriage should be of a weight proportionate to that of the gun; too heavy, it would promptly be destroyed by the shocks given it by the gun; too light, it would have an inconvenient recoil. The weight of the carriage ought always to be less than that of the gun. A very heavy gun upon a light carriage always does better service than a light gun upon a heavy carriage.

154. **Limit to Recoil.** On board of a ship, the limited space that we have at command in the rear of the battery renders it necessary to restrain the recoil within

certain limits ; we see, therefore, that we must diminish the recoil, either by friction properly managed, or by the elasticity of cordage, and avoid shocks which, are always injurious to the carriage.

155. **Friction Carriages.** Carriages of various forms have been proposed for adoption, in which the recoil is restrained by friction ; these usually consist of a slide and top-carriage, the friction of the latter on the slide being increased by a clamp and compressor, to be compressed before firing. The general objections to this arrangement are, 1st, that the crew of the gun may, in the heat of action, forget to compress the carriage on the slide, thereby greatly endangering themselves, and probably destroying the carriage ; 2d, that a shot striking any one detail of the system may derange all, and disable the gun.

156. **Breeching.** In general, the recoil is restrained by the aid of the *breeching*, a piece of rope of such length as to permit the muzzle of the gun to come within the port, and of a strength proportioned to the moment of recoil. The breeching is rove through an opening in



the cascade, through the breeching shackles on the brackets, and the ends shackled to the *starts*, fig. 30, in the bulwarks on each side of the port. The breeching as thus arranged, does not fulfil all the conditions required, because the strain upon the two legs when the gun is fired obliquely, is not equalized.

157. **Compound Breeching.** A compound breeching of chain and rope was proposed, some years ago, by

Colonel Romme, of the French service; the rope portion was rove through the cascable, and was long enough to fit the round of the breech, a portion of chain connected each end with a single forked breeching bolt, secured below the centre of the port sill. When the gun was run out, the breeching, which was spanned together at the breast of the carriage, bent below the carriage by its own weight, without requiring the aid of two men of the gun's crew, thereby reducing, by so many men, the necessary complement of each gun without impairing its efficient service. When firing obliquely, the breeching fastened to only one bolt in the side of the ship, is always equally strained.

This breeching, notwithstanding some apparent advantages, did not advance into favor, probably from the liability of the chain to be struck by shot, in which case the pieces, flying in every direction, would become so many instruments of destruction.

158. **Trucks for Navy Gun-Carriage.** The friction of a wheel is proportional to the ratio between the radii of the wheel and axle. The recoil of the carriage may be diminished by decreasing the diameter of its wheels, or increasing that of its axle. For this reason gun-carriages for sea service are mounted upon trucks, a species of solid wheel of small diameter. When the gun is discharged, the trucks, at first, slide upon the deck without turning, and it is not until a certain time has elapsed, depending upon the velocity of recoil, that they begin to rotate; but as soon as their friction is overcome, the motion becomes uniform, and the recoil would be of considerable extent if it were not checked by the breeching.

159. **Effect of Height of Carriage.** The position of the trunnions also exercises a certain influence upon the recoil; the higher the trunnions are raised above the axle-trees, the longer is the arm of the lever which presses the the inner trucks against the deck, and the more will the recoil be diminished.

In general, the carriage must have such stability that it will not be liable to capsize when under fire, or by the pitching of the vessel; nor to fall over on its face by the rolling, or when fired to leeward; this last defect can be remedied by placing the trunnion holes some distance within the outer axle-tree. It must have facility of horizontal motion for lateral training, and convenience of vertical motion, or elevation and depression to the extent that experience has shown to be necessary for the service to which it is destined.

160. **Deterioration of Gun-Carriages.** The prompt deterioration of wooden gun-carriages, when exposed to the weather, particularly in tropical climates, induced artillerists to attempt the substitution of iron as a material for their construction. These iron carriages are of wrought as well as of cast metal, and the most simple arrangement of the material has been adopted to insure the greatest strength, without an excess of material.

161. **Cast-Iron Carriages.** The experiments on cast-iron carriages have been principally carried on in France, Russia and Prussia; and it is found that carriages made of this material are liable to many and serious objections; if the guns they support are also of iron, it frequently happens that, with heavy charges, they are broken by the shock of the trunnions. This may occur even with a charge of one-third the weight of the ball,

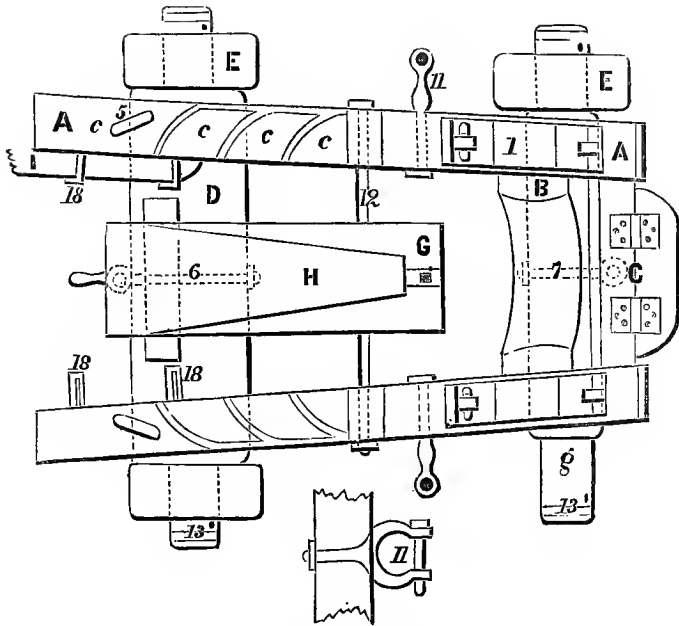
consequently we can employ no greater charges than one-fourth. If the battery in which they are placed be exposed to the fire of an enemy, a ball striking them breaks them into numerous pieces, which fly in every direction, and may cause the greatest destruction.

162. **Wrought-Iron Carriages.** In the United States, similar experiments have been made, but more especially in regard to wrought iron, that having been deemed the better material of the two. The results have been so satisfactory that wrought-iron carriages have been recommended for use altogether in garrisons. A carriage of this material, made after the plan proposed for garrison use, was submitted to every test to which it would be exposed in service, and sustained, satisfactorily, four thousand rounds without requiring, for the last two thousand, any repairs whatever. The use of iron carriages will probably be limited to garrison and light field artillery.

163. **Three forms of Carriages.** Among the various carriages that are proposed for our consideration, there appear to be but three forms; in one, the body is entirely supported by wheels or trucks; in a second, partly by trucks and a part upon a portion of the body which slides upon the deck; in the third, a bed, or top-carriage, moves upon a slide, which has, in general, motion around a pivot.

164. **Navy Four-Truck Carriage.** We will first review the common gun-carriage, and note its excellencies and defects. Figs. 30, 31, 32, 33, 34, 35.

Fig. 31.



## WOODEN PARTS.

The *brackets, A*, are made each of two pieces joined by a jog, *a*, and dowed. The remaining parts of the brackets are the *trunnion-holes, b*, *steps, c*, *quarter-rounds, d*, and *arch, e*.

*B*, *Transom*.

*C*, *Breast-piece* in two parts, the inner part fixed, the outer part movable, connected by hinges.

*D*, Front and rear axle-trees consisting each of square body, *f*, and *arms, g*.

*E*, Front and rear trucks.

*F*, Dumb trucks.

*G*, Bed and stool.

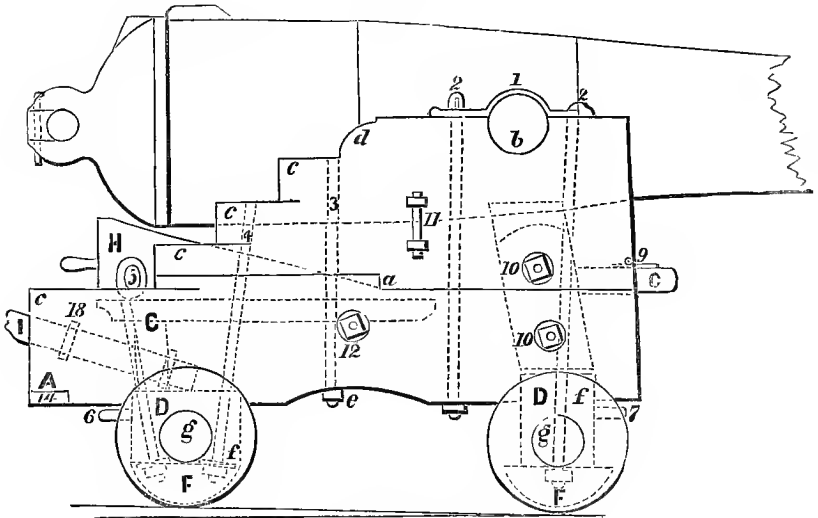
*H*, Quoin.

*Implements—J*, Handspikes. *K*, Chocking quoin.

Fig. 32.



Fig. 33.

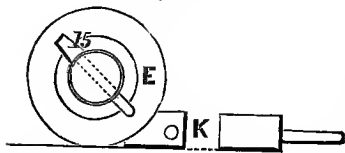


## METAL PARTS.

1. Two capsquares.
2. Four capsquare bolts and two keys.
3. Two bracket bolts.
4. Two rear axle-tree bolts.
5. Two side tackle eye bolts.
6. One traintackle eye bolt.
7. One transporting eye bolt.
8. Breast bolts.
9. Two hinges of breast pieces.
10. Two transom bolts (upper and lower).
11. Two breeching shackles and pins.
12. Bed bolt.
13. Four axle-tree bands.

14. Two chafing plates.
  15. Four lynch pins and washers.
  16. Quoin plate and stop.
  17. Ratchett for quoin stop.
  18. Four training loops.
  19. Breeching thimble (cast iron).
  20. Side shackle bolts for breeching.
  21. Shackle pin, plates and keys.
165. **Dimensions.** The arms of the axle-trees are two calibres in length, and one in diameter. The trucks are a calibre in thickness.

Fig. 34.



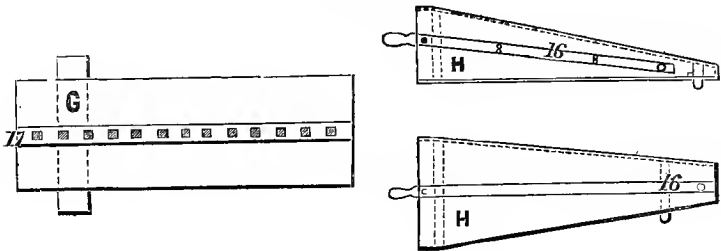
The brackets are a calibre in thickness, and of a height corresponding with the height of the port from the deck.

The transom is a calibre in thickness, and as broad as the space between the forward axle-tree and the gun will permit.

166. **Breast Piece.** The inner part of the breast piece slides into a mortice in the brackets in front of the transom; the height of its position in the carriage equals that of the lower sill of the port. The outer part hinges on the inner part. When the outer part is turned up, the carriage can be run out so as to have its fore trucks resting against the waterways, while the breasts of the brackets rest against the spirketting; by this means the weight of the gun and carriage is not allowed to concentrate on any one point of the side, a consideration of much importance when the guns are secured for sea, and the ship rolling heavily; when the outer part of the breast-piece is down, the fore trucks are brought well inboard, clear of the waterways, and the arc which the

breast piece then presents to the spirkettling enables the gun to be trained laterally, which is impossible when the gun is run out with the breast piece up.

Fig. 35.



167. **Bed and Quoin.** The bed and quoin are arranged to produce all the elevation and depression that the port admits; and, to prevent the quoin from flying out under the shock of firing, it is furnished with an iron projection on the bottom, which catches in the ratchett secured to the bed. The bed is kept in its place by being keyed to the bed bolt, as under fire it tends to fly forward. The inner end of the bed is supported by the stool, which rests on the rear axle-tree.

The transom and bed bolts hold the brackets firmly in their place.

168. **Trunnion Holes.** The trunnion holes, in which the trunnions rest, are cut with their centres distant two calibres from the fore ends of the brackets.

169. **Bolts connecting Brackets and Axle-trees.** The fore capsquare bolts, and the side tackle and rear axle-tree bolts pass through the brackets and axle-trees, thus securing them strongly to the brackets.

170. **Use of the Steps.** The steps of the carriage are the offsets in the brackets, providing a fulcrum for the handspikes in elevating or depressing the gun.

This gun-carriage has continued in its present form and proportions, without material alteration, for nearly three hundred years. It is, however, acknowledged to have great defects, which have caused many attempts to improve it. But no new carriage has yet recommended itself so far as to be adopted to the exclusion of the old one.

171. **Advantages of the Four-Truck Carriage.** The good points about this old carriage which have caused it to be adhered to through so long a time and so much service, are, 1st, strength; 2d, simplicity; 3d, stability; 4th, transportability; 5th, capability, in case of parting a breeching, of being brought up to its port again for reeving a new one without difficulty or delay. These points are all absolutely indispensable.

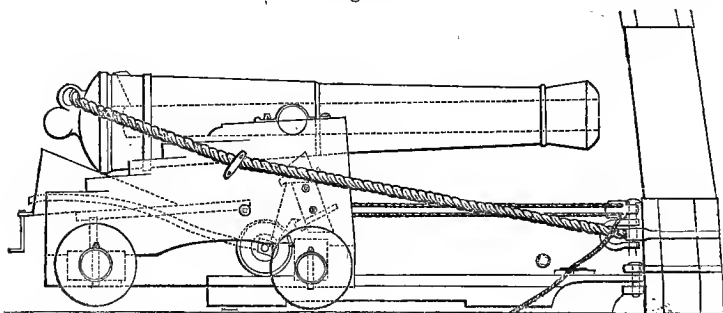
172. **Objections to the Four-Truck Carriage.** The objectionable features of the carriage are, 1st, it is, in recoil under a gun, very hard on the breeching; 2d, it requires great force to get it out to battery, but if it be made to move out easier on the trucks it will recoil more violently on the breeching and *vice versa*, so that it is difficult to remedy one of these evils without increasing the other; 3d, it gets out of the centre of the port, and in a sea way or under much heel of the ship is with difficulty and delay brought back to its proper central position; 4th, it trains slowly and unsteadily through a limited sweep, and the gun on it cannot be fired instantly when the sight is on with the object, but notice must be given, and a moment's delay experienced, for the crew to "drop tackles" and "unship handspikes," in which moment the yawing or rolling of the ship may throw the sight off the object; 5th, when the ship has

much heel, it is difficult to take in the slack of the train tackle, as the lee gun recoils, fast enough to catch and hold it in sufficiently far for loading,\* in which case the delay and labor of getting it in is considerable; 6th, when trained obliquely it recoils with an unequal strain upon the two legs of the breeching and their bolts; and 7th, when a lee gun runs out violently, the effect is to injure the ship, and by starting the shot from its seat endanger explosion of the gun.

173. **Ward's Gun-Carriage.** The late Commander Jas. H. Ward, of the U. S. Navy, proposed some years ago a modification of this carriage, which obviates many of the objections.

He alters the common service carriage by removing the dumb trucks, fig 36, and bolting a fore and aft piece

Fig. 36.



between the axle-trees, and introduces a fixed roller handspike immediately beneath the trunnions. This carriage is then placed on a slide of such height as to lift the trucks clear of the deck. The ends of the breeching are spliced together, and shackled to a bolt below the centre of the port sill.

\* This objection is removed by the use of the chocking quoins.

The defects of this carriage seem to be the injury done to the deck by the proximity of the slide, which would keep the lower decks from drying, also the weight and expense of the slide.

The advantages, however, outweigh the defects, for this carriage possesses many characteristics superior to those of the common carriage. These are, convenience of running out, ease of recoil, facility and steadiness of ordinary train, combined with equal transportability (a want of which is the most common defect of slide carriages), an equal strain is brought on both legs of the breeching, the gun is always in the centre of the port, and there is no necessity for the precautionary order, "ready," before firing.

Commander Ward has introduced some improvements lately, in connection with his carriage. The injury to the deck is obviated, being less now than with the old, or the Marsilly carriage; the weight of the slide is reduced and its strength increased. The question of cost seems to be a less important element in considering equipments than formerly, especially since late campaigns have shown that want of equipment costs most in the end, and economy in equipment proves to be the worst sort of economy, or none at all, if not lavish extravagance.

174. **Comparison of Ward's Carriage with the Four-truck Carriage.** The important question as to extent of training has been satisfactorily tested on board of the receiving ship North Carolina, at New York, where a carriage of this description, named by its inventor the *Novelty Carriage*, stood side and side with the old one in the battery. On each carriage was mounted an old

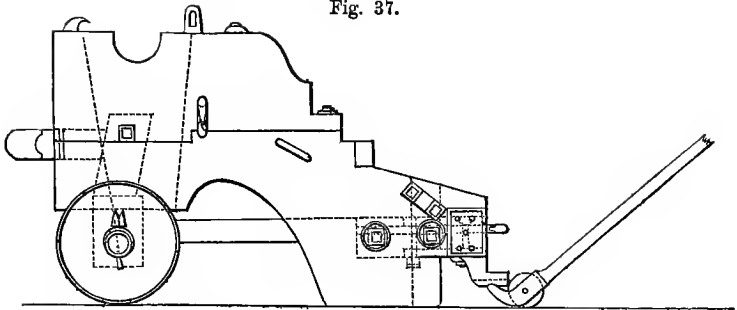
32-pounder gun of 61 cwt., both had equal breast pieces, and, when pointed abeam, projected equally beyond the ship's side; both, as they were trained to bear on the same object, showed the same projection, and both, when trained to the utmost (that is, with the old 4-truck carriage run out in the extreme after side of the port, then trained forward until wooded), bore on exactly the same object, and had exactly the same projection. The difference showed itself in favor of the Novelty Carriage by the great facility with which it could be jerked around from extreme forward to extreme aft. This rapid training is effected by means of a roller handspike, having two rollers, one on each side of the handspike, whose axes are parallel to the handspike, this, being placed under the rear of the slide, raises it from the deck, when the carriage is then easily trained by means of the usual handspikes shipped in the training loops; the curved form of the roller handspike enables the gun to be fired without unshipping it, which operation would have to be performed if the handspike were straight, as the slide is so short that the carriage, when in, projects some distance inboard of the slide.

It is a remarkable fact that this carriage, the invention of an officer of acknowledged ability, has never had a fair trial in the service; it is the opinion of many competent judges that it requires only the favor of opportunity to make its advantages apparent.\*

175. **Marsilly Carriage.** The Marsilly (navy 2-truck) Carriage, fig. 37, has superseded all others, in the French navy, for heavy cannon mounted in broadside. It dif-

\* The accomplished ordnance officer now at the head of the Bureau of Ordnance, has recently given orders for a fair trial of Ward's carriage.

Fig. 37.



fers from the common carriage in suppressing the rear axle-tree, and extending the brackets to the deck, upon which they rest, and by their friction check the recoil; running out is facilitated by a roller handspike placed under the rear of the carriage. Objections were raised to this carriage in consequence of its seeming to be deficient in transportability, but the following extract from the exercises of the Merrimac, under the command of Captain Hitchcock, proves the objection to be without force.

EXTRACT FROM THE EXERCISES OF THE UNITED STATES SHIP MERRIMAC, COMMANDER HITCHCOCK.

Transporting from side to side.

	WEIGHT.			TIME.
viii-inch	7,000 lbs.	.	.	1 m. 23 s.
ix-inch	9,000 lbs.	.	.	1 m. 45 s.

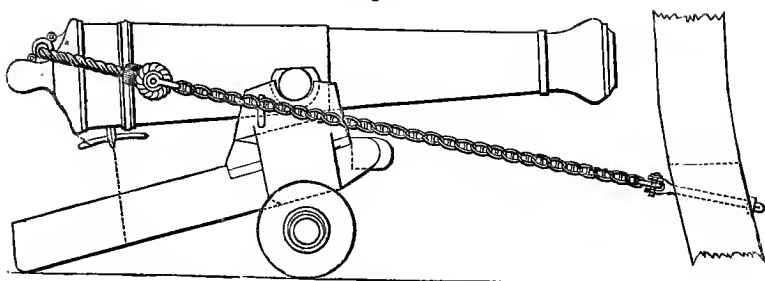
"The guns were in, and the time taken from the order to 'load and fire,' to the second fire. The gun was loaded, run out, fired, sponged, loaded, transported to the opposite port and fired.

"The guns with Marsilly carriages were readily moved by shipping the handspikes in the training loops, raising the after transom off the deck, and moving the piece wheel-barrow fashion."

This carriage has been adopted by the Bureau of Ordnance and Hydrography, and is the carriage on which the nine-inch gun is always mounted in broadside. This is the only carriage that has ever superseded to such an extent the old four-truck carriage in our service, and this has not been adopted until experience had fully proved its great merit. When mounted upon it, the heavy guns of Commander Dahlgren are worked with ease in a heavy sea-way. In thus acting in a deliberate manner before making an innovation, we have pursued the wisest course, and have followed the example of the French, whose system has been truly "systematic," rather than that of the English, whose system has been "experimental," we have not been led off by every thing that looked like an improvement, and so filled our stores with useless old material, but we have waited until experience had fully shown the advantage of the change. The English *Aide Mémoire to Military Sciences* says: "The great extent to which our *accidental* system has been carried, is now so great as to render alteration, to any great amount, well nigh impracticable. We have, at this moment, upwards of fifty authorized descriptions of ordnance, and in but few instances can the gun-carriage of different sorts of pieces be replaced by those of another kind in case of accidents."

176. **Romme Carriage.** The Romme Carriage, fig. 38, is worthy of notice as having attracted much attention, at one time, from the French service, and was partially adopted as one of a mixed battery into their service, but subsequent experience condemned it. Its general form is that of the stock trail field-carriage. Its advantages

Fig. 38.



over the common carriage consist in running out easier, recoiling less, greater ease, steadiness, and extent of train, permits a greater number of rounds to be fired in the same time, costs less, is lighter, being composed of fewer pieces, less liable to get out of order in ordinary service, and can be used with almost equal facility at sea or on shore; it occupies less space on deck, presents less surface to the fire of an enemy, and recoils equally on the two legs of the breeching (see breeching of Colonel Romme).

This carriage, however, has two inherent defects, in not giving sufficient elevation for extraordinary cases, and in having a tendency to fall over on its breast in firing to leeward, or when the ship is rolling. If we attempt to obviate this last defect by shifting the position of the trunnion holes, we increase the difficulty of train

Fig. 39.

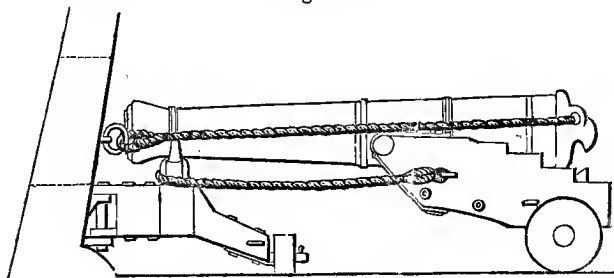
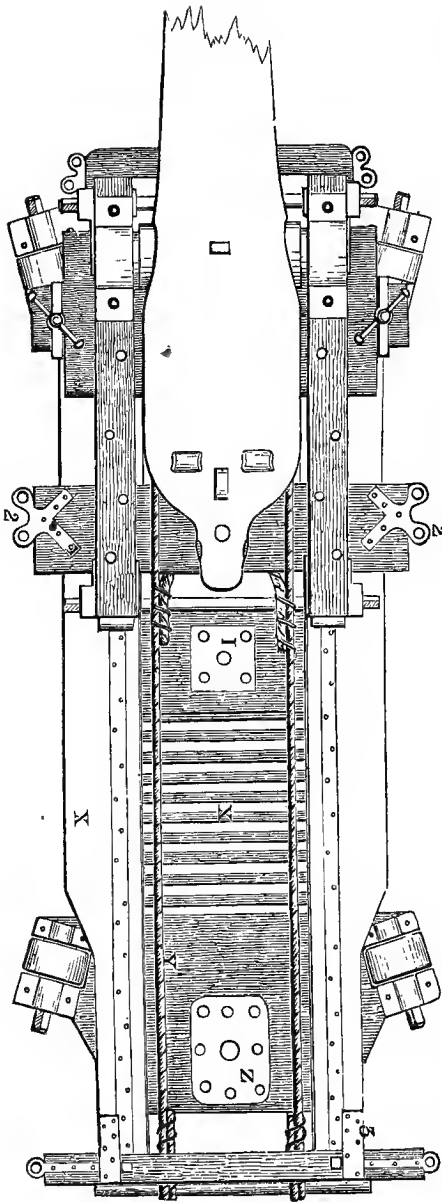


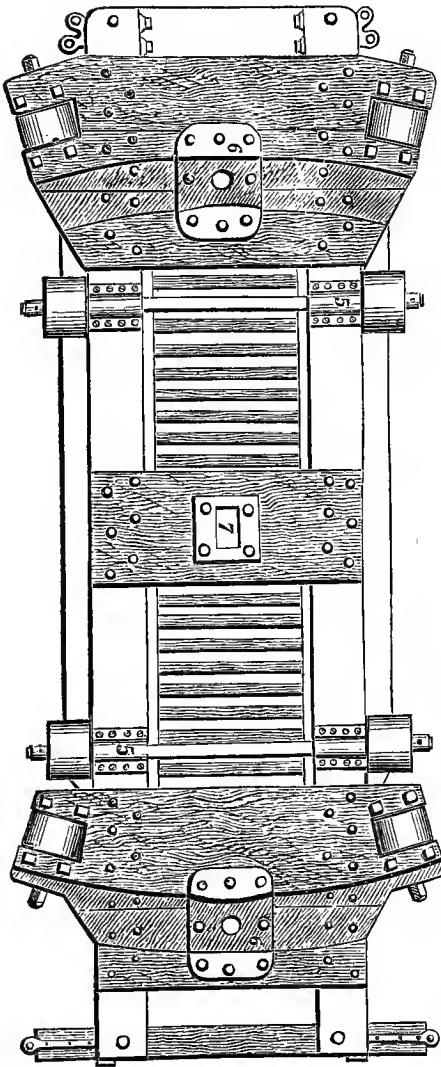
Fig. 40.



and running out, and the trail has so much friction as to cut up and destroy the deck.

177. **Marshall Carriage.** Another carriage experimented on at the same time with the Romme carriage, by a board of French ordnance officers, was the Marshall carriage, fig. 39, invented by Commander Marshall of the English navy. They report on this: "Easy to charge, the muzzle of the gun resting at a convenient height after the discharge. It affords the captain of the gun the opportunity of firing when his aim is on, without compromising the safety of the gun's crew, except when the lateral training passes beyond twelve or thirteen degrees forward or abaft the

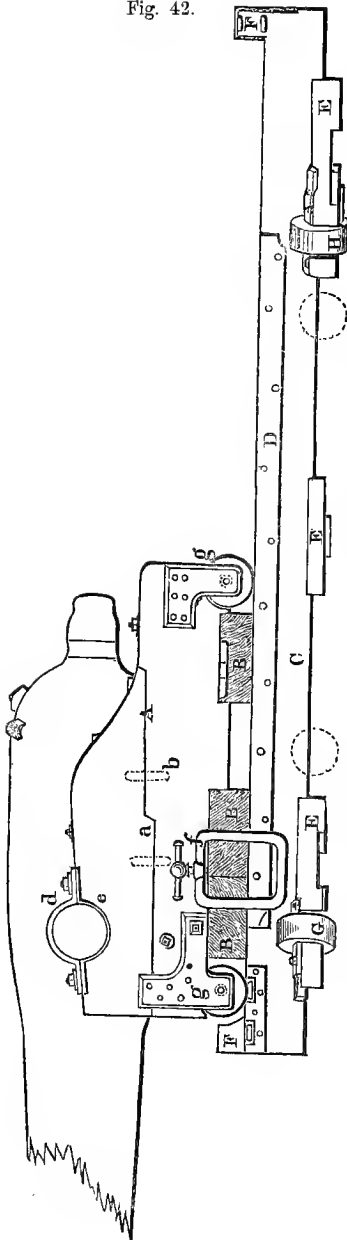
Fig. 41.



beam, or if the elevation is to be altered, when the preponderance at the breech is so considerable that it is only with great exertion and labor that the movement can be effected. This carriage is singularly hard upon the breeching, which it is necessary to shorten in from time to time, for if this precaution be neglected, the gun is liable to leap from the pivot-crotch, and pitch muzzle down upon the deck, which it would require great labor and time to replace. Difficult to shift from side to side, or from port to port. It cannot be mounted on shore to attack or defend a post which

it is desired to carry or preserve, an advantage possessed by both the ordinary and Romme carriages. It does not admit of quicker firing than the last, especially

Fig. 42.

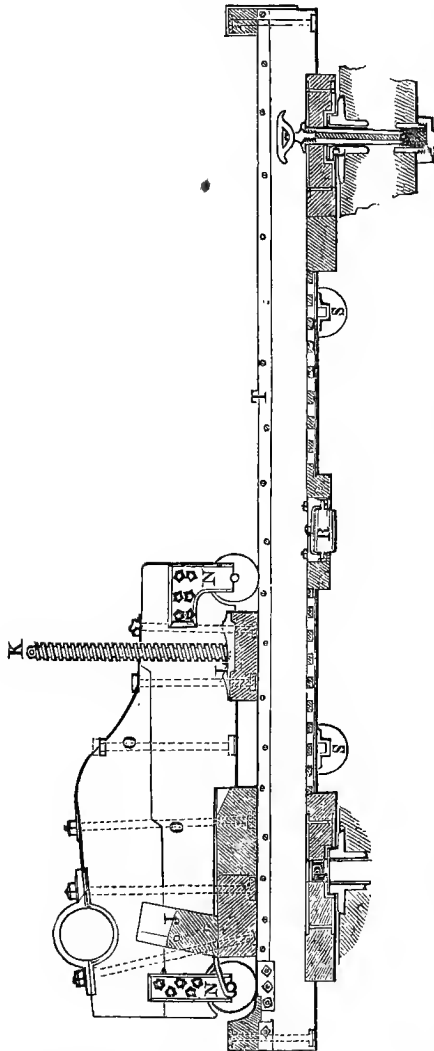


when the aim is to be altered, and has the further marked inconvenience of keeping the muzzle of the gun so near the port that the explosion is nearly always followed by a dense smoke which comes in-board, accompanied by sparks, which would favor combustion in the batteries, besides setting fire to the channels if mounted on a gun-deck. The report also of the discharge is especially annoying to the gun's crew, and to those of the adjacent ones."

#### 178. Ehrestham Carriage.

What has just been said of the Marshall carriage applies equally to the Ehrestham carriage, which differs in no respect from the Marshall, except in the disposition of friction clamps, designed to moderate the recoil. These clamps fulfil their design, but considerably complicate the handling of the carriage. It cannot be

Fig. 43.



transported from one side to the other in the battery, without recourse to machinery prepared to effect the movement, which leads to the conclusion that the Marshall carriage, with all its faults, is to be preferred to it. In 1850, a Swedish frigate, on the coast of Brazil, had her main deck battery mounted on this carriage, but it was not spoken well of by those who were shipmates with it.

#### 179. Pivot Carriages.

Guns, which are expected to be fired at greater elevations than the dimensions of ports will allow, are mounted upon pivot carriages. These carriages are formed of two parts, viz.: the brackets and their connections forming a top-carriage or bed, which is fitted to work on a slide. The slide is secured by a pivot bolt at one of its ends, upon which it is

traversed to bring the gun to bear upon an object, or to change its position for firing.

180. **Top Carriage.** The carriage differs from the common carriage in the suppression of the axle-trees, and the substitution in their place of three transoms, front, middle and rear, the lower sides of which, forming a plane surface, rest upon the slide, and by their friction modify the recoil. This carriage has a fourth transom, called the breast transom, occupying the same position as the transom of the common carriage.

181. **Slide.** The slide consists of two rails, slats extending across from the lower edge of one, to the lower edge of the other. The rails are jogged into transoms, front, middle and rear. Attached to the lower part of the front and rear transoms are rollers on eccentric axles, those of the rear transom being required for training, and those of the front transom being required for shifting; formerly there was no roller under the middle transom, but the length of the slide, and its consequent tendency to sag down in the middle, has caused the introduction of a roller under the middle transom in order to give support to the slide at that point.

Projecting from the outside of the rails are two flanges or compressor battens, one on each side. The lower lip of the compressor takes under this batten, while the upper bearing is in a socket let into the upper surface of the middle transom of the carriage, the compression of the batten between the carriage and the lower lip of the compressor is effected by means of a screw.

Figures 40, 41, 42, and 43, taken from the ordnance instructions, for the navy, for the year 1860, give the

official statement of the construction, &c., of the pivot gun-carriage in use in our service.

NOMENCLATURE OF PIVOT CARRIAGE.

Fig. 40.

*Wooden Parts.*—X. Battens and slats; Y. Rope stays.

*Metal Parts.*—Z. Upper pivot plate. 1. Middle roller plate. 2. Eyes for tackles. 3. Hurter straps. 4. Rail plates.

Fig. 41.

All metal parts are composition, except the axles, levers, elevating screw, and bracket bolts.

*Metal Parts.*—5. Transporting journals. 6. Pivot plates and guide flanges. 7. Middle roller.

Fig. 42.

CARRIAGE.

*Wooden Parts.*—A. Brackets, of two pieces with jog (*a*), and dowels (*b*); B. Transoms, front, middle and rear (projecting beyond the rails), jogged into brackets.

*Metal Parts.*—*d.* Capsquares; *e.* Trunnion plates; *f.* Compressor with screw and lever; *g.* Rollers and journal plates.

SLIDE.

*Wooden Parts.*—C. Rails; D. Compressor battens; E. Transoms, front and rear, each in two parts, middle in one part; F. Hurters, front and rear.

*Metal Parts.*—G. Shifting trucks; H. Training trucks with journals and eccentric axles.

Fig. 43.

CARRIAGE.

*Wooden Parts.*—J. Breast Transom, scored for elevation, as is also the middle transom.

*Metal Parts.*—K. Elevating screw; L. Saucer; N. Inside journal plates; O. Bracket bolts.

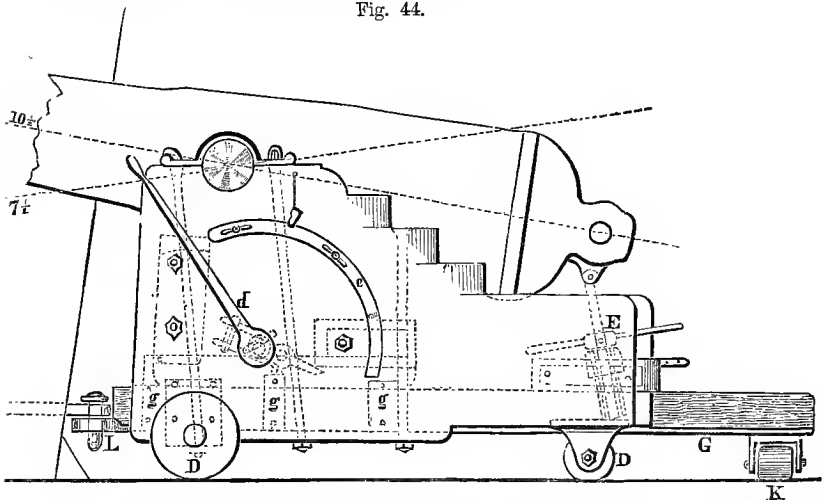
SLIDE.

*Metal Parts.*—P. Bossed sockets, plates and pivot bolts; R. Middle training truck, with journals; S. Transporting trucks, axles and journals; T. Guide plates, inside of rails.

183. **Van Brunt's Carriage.** Captain Van Brunt, of the United States Navy, invented a carriage some years ago, which, in its original form, was submitted to numerous tests in service, with but indifferent success. This carriage has lately been very much altered and im-

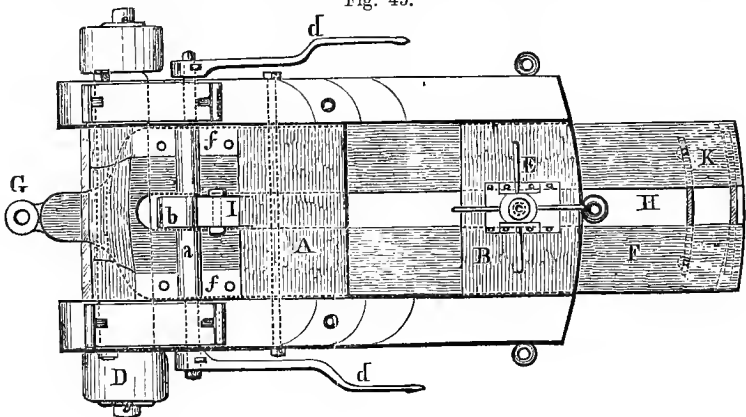
proved, and, in its present form, possesses characteristics which recommend it for use with broadside guns, particularly for light guns. It is a friction carriage, consisting of a top-carriage and slide.

Fig. 44.



The carriage differs from the common carriage in the suppression of the axle-trees, and the substituting, in their stead, of transoms; the carriage is placed on a slide, but four trucks which are secured to the brackets

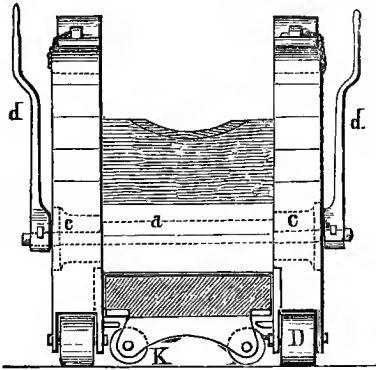
Fig. 45.



of the carriage by brass boxes and axles, resting on the deck at the sides of the slide, support the weight of the carriage, thus keeping the transoms of the carriage from resting upon the slide. This enables the carriage, in running out, to move freely on its trucks, as the common carriage.

In order to restrain the recoil, friction is produced by means of an eccentric shaft running across the carriage, fig. 45, having levers attached to it, which, when hove down, press two compressor blocks, *f f*, down on the upper surface of the slide, pressure on the under side

Fig. 46.



of the slide being at the same time produced by clamps *g g g*, fig. 44, which project a short distance under the slide. When the levers are hove down, then the slide is compressed between the compressor blocks on the upper side and the clamps taking on the under side. Train-

ing trucks, *k*, fig. 46, are attached by a brass box to the rear end of the slide.

183. The parts peculiar to this carriage, are,

OF CARRIAGE.

A, middle transom; B, rear transom; compressor composed of eccentric axle *a*, with catch *b*, journals *c c*, levers *d d*, spring catch for levers *e*, compressor blocks *f f*, and clamps *g g*; trucks D, attached to brackets by brass box and axles; and elevating screw E (Hart's), with levers, attached to rear transom.

## OF SLIDE.

Slot H, with catch-stop I. Training trucks K, attached by brass box. Pivot-bolt, loop, and socket L.

184. **Van Brunt's Carriage a Self-Compressing Carriage.** It is urged as an objection to friction carriages that, during the excitement of an engagement, the men may forget to tighten the compressors, and it is to obviate this objection that the catch-stop I, the catch *b*, and the spring catch for levers *e*, have been introduced into this carriage, making it a *self-compressing* carriage. Should the gun be fired before the compression has been made, the catch *b* will hang down in the slot below the level of the catch-stop I; as the gun recoils the catch *b* comes in contact with the catch-stop I, which contact turns the axle, bringing down the levers, which are caught by the spring catch *e*, thus effecting the desired compression, and preventing the return of the levers to the vertical position, which they occupy when the carriage is at liberty to move freely on its trucks.

It is argued that as the spring catch projects from the side of the bracket it will be always likely to foul ropes, &c., particularly on the spar deck; this is one of those objections which can only be answered by experience; as yet no opportunity has been afforded of testing it. The carriage has many fine points, and may be placed alongside of that of Commander Ward, with which it has some points in common. It is more elaborate, and has more appliances than the "Novelty Carriage," which would seem to make it much more expensive and much more vulnerable, that is, more likely to be disabled by a shot from an enemy, but experiments may show that its merits may justify the extra expense.

185. **Methods of obtaining Elevation and Depression.** In connection with the subject of gun-carriages, we will consider the methods in use for procuring elevation and depression.

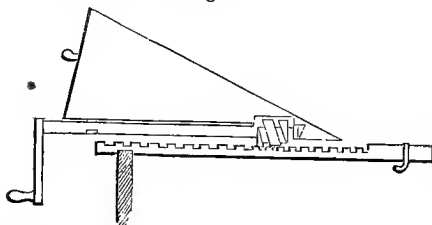
186. **Bed and Quoin.** The most ancient method is the *bed and quoin*. This method, retained until lately, in its original simplicity, is both inconvenient and dangerous; the elasticity of the carriage usually causes the quoin to jump out of the bed at each fire, endangering the men at the gun, and requiring time to replace it; not unfrequently the ratchett is made of cast iron, and is broken by the force of recoil. When rapid changes of elevation, however, are required, it has advantages over any other method; it will also admit of greater extremes of elevation and depression.

187. **Elevating Screw.** The *elevating screw*, which is readily removed and replaced, has a manifest superiority in its stability and uniformity over the old bed and quoin; it is wanting in rapidity of motion, but great changes of elevation are seldom required at sea. The best screws in the U. S. Navy are those of Dahlgren and Hart; the former's is a single screw working through the cascable; the thread of the screw is so adjusted that one complete turn is equal to a degree of elevation or depression. Hart's screw consists of a male and female screw, which are entirely buried in the axle-tree when extreme elevation is required.

188. **Ward's Screw-Quoin.** The *screw-quoin*, proposed some years ago by Commander J. H. Ward, and attached to his Novelty Carriage, presents advantages which make it compare well in efficiency with the elevating screw.

A shaft was secured, along its entire length, on the under side of the quoin, having on its end a male screw, only half of which projected below the quoin; on the upper side of the bed, in place of the ratchett, was laid

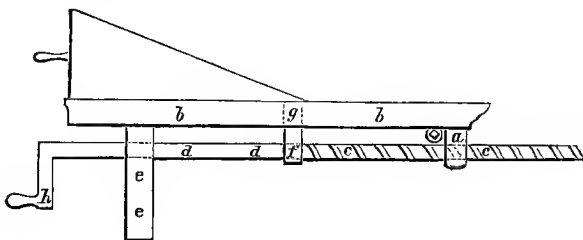
Fig. 47.



a half female screw in which the screw on the quoin worked. A crank projected inboard of the shaft, by which the screw was turned. The test of this screw-quoin developed objections which have been obviated by the inventor in the following manner.

**Ward's Improved Screw-Quoin.** Instead of the long half female screw extending the length of the bed, he now

Fig. 48.



secures to the end of the bed, beyond the bed bolt, a short female screw or nut *a*, which hangs below the bed *b*, and in place of the short male screw he introduces a long male screw *c*, as long as the quoin, tailed with a shaft *d*, also as long as the quoin. The bed has a slot where the half female screw was placed in the original invention. The shaft is supported at its rear end by passing, with a close fit, through the stool *e*. The quoin is secured to a collar *f*, near the junction of the shaft

and male screw, by a piece *g* projecting from the quoin, passing through the slot in the bed, and keying to the shaft collar. As the screw recedes, it carries back the collar and, consequently, the quoin attached to it, and both the handle of the shaft *h* and the quoin recede together.

This arrangement of the screw-quin has endured all the tests that it has as yet been subjected to, some of which have been very severe: at one time the thirty-two pounder, of sixty-one cwt., which was mounted on the Novelty Carriage on board of the receiving ship at New York, and to which was attached the improved screw-quin, was loaded with nine pounds of powder, and sixty pounds of closely packed wet sand, filling the gun to near the muzzle; when fired, the recoil was desperate, but the quoin did not move. The elevation and depression are a degree to a turn, and, in extent, all that the port admits.

The screw-quin seems to combine within itself all the advantages of the screw as well as those of the old bed and quoin, for it possesses the accuracy and stability of the vertical screw and its uniformity of motion, combined with greater rapidity of motion than that possessed by the old bed and quoin, but without the inconvenience and danger resulting from the liability of the old quoin to jump out under fire.

The present system of working both sides in the United States Navy, though the best that is practised, does not enable a ship to deliver her fire rapidly, with her guns mounted on the old, or the Marsilly carriages; but the guns mounted on the Novelty Carriage, with the improved screw-quin attached, could be worked by

half-crews as rapidly as the whole crews could work them mounted on the old carriage, and this fact is a strong argument in favor of adopting the Novelty Carriage into the service, if future practice should not develop some defects which are not now apparent.

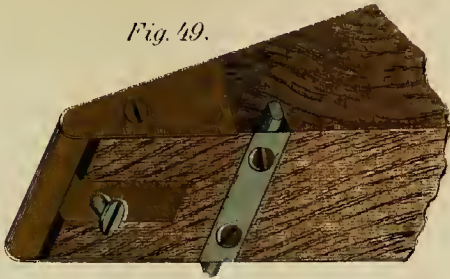
189. **Porter's Quoin.** Lieutenant D. D. Porter has introduced a modification of the old bed and quoin, which admits of their being used without the danger of the quoin flying out, and which also presents some other advantages. The stop on this quoin projects a certain distance below the under surface of the quoin, fig. 49, plate II., and is terminated by a head, which, being entered in the slot in the bed, preserves the axes of the bed and quoin in the same plane. Two projections, one on each side of the quoin, rest in the ratchetts on the bed, fig. 50, plate II., and prevent the quoin from flying out when the piece is discharged. The forward end of the quoin has a roller, on which it moves easily when the elevation is being changed, which is effected by *raising* the large end of the quoin, the neck of the stop being long enough to allow the projections on the sides of the quoin to be lifted clear of the ratchetts. Fig. 51, plate II., represents Porter's bed and quoin fitted for a pivot gun-carriage.

One advantage of this arrangement is, that the value, in elevation, of each notch of the ratchetts being known, we know the inclination of the axis of the piece from the position of the quoin; and this information would be of great importance at night when the breech sight could not be used for the purpose of directing a line of sight on the object whose distance was known. For example, suppose, in a harbor the ship on an even keel,



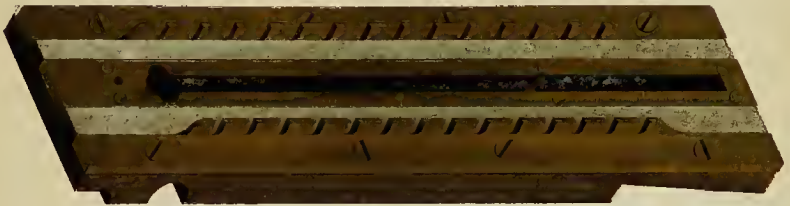


Fig. 49.



Porters Quoin.

Fig. 50.



Porters Bed.

Fig. 106.



Fig. 51.



Porters Bed & Quoin.

English Friction Primer.



it is necessary at night to fire at an object whose distance is known, the plane of fire might, with considerable accuracy, be made to pass through the object if at all visible, but the adjusting of the elevation by means of the breech sight would be a difficult and tedious operation; in such a case the notch of the ratchetts would at once give the necessary elevation, and in placing the quoin the captain of the gun would only have to feel for the notch. The tests to which this quoin have been subjected have been very satisfactory, and it may be considered now as the established quoin of the United States Navy when quoins are used.

190. **Rule for Mounting Guns.** The lower guns of a ship are usually carried from six to nine feet from the water. This establishes nearly the centre of the port. Ports are commonly three feet high, and three and a half feet wide. The gun-deck is usually laid from twenty to twenty-four inches below the bottom of the port. In mounting guns the rule is to place the centre of the trunnions in a horizontal plane, which is half a calibre below the plane passing through the centre of the port; consequently the gun-carriage must be high enough to sustain the gun in that position. The object in giving more space in the port above the gun than below, is that it may have more elevation than depression. This size of port and position of gun admit of about eleven degrees of elevation, and seven degrees of depression with the plane of the deck. When, therefore, the ship heels seven degrees, a weather gun may be placed level with the horizon, and a lee gun may be elevated four degrees with the horizon.

## CHAPTER V.

## GUNPOWDER.

191. **Origin of Gunpowder.** The inflammable property of a mixture of nitre, charcoal, and sulphur, was known long before its projectile force was discovered. Used in the form of dust, it is supposed by many to have been the substance of which the rockets and Greek fire of the ancients were made.

192. Gunpowder is said to have been discovered in Europe somewhere about the thirteenth century; but a somewhat similar compound is supposed to have existed many centuries before in China. Until toward the close of the fifteenth century it was used in the dust form, but about that time it was discovered that when formed into grains, its force was very considerably increased.

As gunpowder has become one of the principal agents in modern warfare, it is important to understand the means of collecting and preparing the materials of which it is composed, and the process of its manufacture.

193. **Nitre.** Nitrate of potassa, in connection with the nitrates of lime and magnesia, is obtained from several sources, among which may be enumerated calcareous caves, certain soils in warm climates, artificial nitre beds, and the mortar of stables, or other buildings long occupied by animals.

Many of the limestone caves in Kentucky, Virginia, and Tennessee, abound in nitrates. In Madison county, Kentucky, there is a cave 1,936 feet long, by forty wide, which contains the nitrates of potassa and lime mingled with the earthy matters in the bottom of the cave. From one bushel of this earthy matter, from three to ten pounds of the nitrate of potassa may be obtained.

The greater part of the nitre used in England is derived from the soil in various parts of the East Indies. It occurs in the same manner in various warm countries, as Egypt, Spain, &c., where it appears to be generated spontaneously at the depth at which the soil retains its moisture, and when dissolved by rains, the subsequent evaporation, by capillary attraction, causes it to rise to the surface, where it is deposited as a crust.

194. **Nitre Artificially Obtained.** In the north of Europe, where nitre does not occur as a natural product, various means have been employed to obtain it artificially; and similar means were used in France during the revolution, when that nation could not be supplied as usual, from Spain and other countries. The *nitre-beds* were most used. These were made by placing loosely on a floor of wood or clay, a layer, three or four feet thick, of calcareous matter, such as marls, calcareous sands, mortars from stables, &c., mixed with earth and various animal products, such as blood, urine, stable manure, &c. Vegetable matter was also found to be useful, probably furnishing potassa. The whole was placed under a shed, and occasionally moistened with additional quantities of blood or urine.

195. **Nitre-Walls.** In the *nitre-walls* used in Prussia, the materials are placed in parallel walls, about six or

seven feet high, and three or four thick, having one face plane, the other cut in steps, which serve to retain the rain which falls upon them. Each wall is covered with a layer of straw to prevent the too violent action of storms. The walls are placed near each other to prevent too rapid evaporation, and in each the materials are mixed with small bushes, which serve to support the walls. Reservoirs are made to collect the water that runs from these walls, and with this the materials are often sprinkled.

When the nitrification is sufficiently advanced, a small thickness is taken off from the plane face, and the nitre extracted. The undissolved residue is mixed with new materials and placed on the side of the steps. The walls are thus constantly decreasing on one side and increasing on the other; and the nitrification not only proceeds without interruption, but, when it has once been established, it proceeds with greater rapidity than at first. Less space is occupied by the walls than by the beds.

196. **Method of Obtaining the Nitre.** The method of obtaining the nitre from the earth of caves, from soils, nitre-beds, walls, &c., is the same for all. The soluble nitrates and other salts are dissolved from the materials by means of water. The solution thus obtained is mixed with carbonate of potassa, or the lye of wood ashes, which contains this salt, and the lime and magnesia are precipitated in the state of carbonates, while the nitric acid, previously combined with those bases, unites with the potassa. The solution is then evaporated, and the nitre crystallized.

197. **Pulverizing Nitre.** Nitre may be pulverized in

a mortar; but the following is the most expeditious method: a pan, with a spherical bottom, is placed over a slow fire, and in this the nitre is placed with water in the proportion of seven pounds of nitre to two quarts of water. The nitre is dissolved, and such impurities as rise to the surface are skimmed off. As the solution evaporates, the nitre is again crystallized, but as the solution is constantly stirred, the crystallization is disturbed and the nitre obtained in the form of a fine white flour. It is by disturbing the crystallization that it is pulverized for the manufacture of gunpowder, and it is in the state thus obtained when first mixed with the sulphur and charcoal.

198. **Charcoal.** The charcoal used in the manufacture of gunpowder is principally obtained from wood, and as the more combustible charcoals are the best for this purpose, the lighter kinds of wood are used for obtaining them. The kinds most used by powder makers are poplar, willow, sumach, alder, linden, hazle-tree, chestnut, and spindle-tree. Wood contains about fifty-two per cent. of carbon.

In Spain flax and hemp are used, but the charcoal obtained is generally inferior to that obtained from wood. The best is obtained from poplar and willow, and in the same tree the younger branches are to be preferred to the older ones. In our own country, the marsh willow and Lombardy poplar are used almost exclusively, and are said to be equally good. When the sap has commenced running in these trees, such branches as are less than an inch and a half in diameter are cut, peeled, and deprived of their pith, when that is found to be large. From these, when dried, the charcoal is obtained.

199. **Obtaining Charcoal by Distillation.** The best method of obtaining charcoal for powder is by distillation. This is performed in cast-iron cylinders, each about five feet in length and two feet in diameter, at one extremity of which the wood is introduced through an orifice provided with a sheet-iron cover. At the other extremity are holes through which a stick of wood is occasionally drawn to ascertain the progress of distillation. Another opening communicates with a canal, by which the gaseous and volatile matters are conducted through condensers to a chimney. The distillation is known to be nearly complete when the vapors which escape are of a yellowish color, and the samples of charcoal of a brownish yellow, brittle, and of good lustre. The fire is then allowed to diminish, and the carbonization to continue by the heat of the cylinder. When this is ended the charcoal is emptied into extinguishers, which are provided with covers to prevent the access of air, and in these it is cooled.

Sometimes the wood to be charred is placed in sheet-iron cylinders, which are placed one after the other in a cast-iron retort. Each cylinder being withdrawn when the wood is charred, becomes itself an extinguisher by having its orifices closed. By this means the process continues without interruption.

Sometimes the wood is placed in an upright cylinder of brick in the centre of which the fire is received in a smaller cylinder of iron. The top of each cylinder being closed, with the exception of a small aperture, the heat is allowed to act upon the wood until it appears that little or no gaseous matter remains to be expelled. The aperture of the inner cylinder is then closed, the

fire becomes extinguished, and the mass is allowed to cool.

Another process has lately been introduced in France, by M. Violette, and considered a great improvement. This consists in transmitting, through the wood, high-pressure steam, producing more effectually even than fire, the desired result.

The charcoal is usually made in the immediate locality of the powder factories, and, as it readily absorbs moisture, is made only as it is wanted.

**200. Temperature at which the Charcoal is prepared.** As the combustibility of charcoal is inversely to the temperature at which it is prepared, it is made for gunpowder at a heat below redness. The method of obtaining charcoal by distillation renders it easy to char the wood uniformly and at a low temperature. When properly prepared, it is light, friable, soils much, and is very combustible. When recently prepared charcoal is pulverized and laid in heaps, it absorbs oxygen so rapidly as sometimes to produce spontaneous combustion; serious accidents have occurred at powder mills from this cause; the charcoal should therefore be exposed several days to the air before it is pulverized.

**201. Sulphur.** Native sulphur is most abundant in volcanic countries, where it is found in lavas, the craters of extinct volcanoes, and sometimes is seen subliming from those still in action. Sicily and the neighboring volcanic islands are examples. Sicily has long supplied all Europe with this article. The color of sulphur is sometimes taken as an indication of its purity, and the citron yellow is preferred to the other colors; the purity, however, can be ascertained by heating it; when pure

it evaporates and leaves no residue. The refined sulphur of commerce, which is commonly in the form of rolls, is used for gunpowder without further purification.

202. **Refining Sulphur.** Sulphur is refined in one of two methods; one is by simply fusing it, when the heaviest impurities sink to the bottom of the vessel, and the lightest rise to the top. The intermediate portion, being left pure, may be withdrawn. The other method is by sublimation, by which the sulphur is vaporized at about 170°, and again condensed in the form of a fine powder called "flowers of sulphur." When melted and run in moulds it is called "roll sulphur."

203. **Treatment of the Materials before Incorporation.** The materials used in the manufacture of gunpowder are first separately pulverized. The nitre is made fine enough by disturbing its crystallization, as above described; but the sulphur and charcoal are generally pulverized in a kind of turning barrel made of iron plates and of prismatic form. Small balls of iron, of the size of musket balls, are placed in the barrel to aid in reducing the materials to powder while the barrel revolves. Thus prepared, the materials are carefully weighed and mixed in the required proportions, these proportions varying according to the uses for which the powder is intended.

204. **Proportions of the Ingredients.** The proportions required by regulation for cannon powder in the U. S. service, are,

Nitre, . . . . .	75 to 76
Charcoal, . . . . .	15 to 14
Sulphur, . . . . .	10'

By increasing the proportion of nitre, the powder be-

comes quicker and better fitted for sporting; by increasing the proportion of charcoal it becomes stronger, but, as this substance absorbs moisture rapidly, the powder will not keep so well. The sulphur is not essential to the strength of gunpowder, but it unites the materials, protects them from moisture, and gives to the grains the firmness required for transportation.

205. **Incorporation.** The materials having been weighed out in the proper proportions, are placed in some mill where they are mixed by beating or otherwise until thoroughly incorporated.

**Pounding Mill.** In some countries the mortar and pestle are used, and the time of beating varies from three to twenty-four hours. The usual time is fourteen. During this process, the materials are moistened sufficiently to prevent them from being thrown from the mortar. The spherical form or pear-shaped is considered the best for the mortar, on account of the facility it gives in bringing the materials under the pestle successively as it rises up the sides. The mortar is made of hard wood, and the bottom, which receives the strokes of the pestle, is sometimes strengthened by introducing a piece of wood selected for its peculiar hardness.

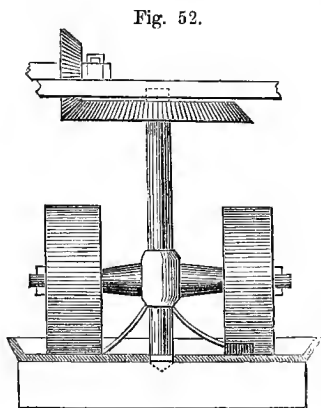
The pestle is made of wood, and is covered at its lower extremity with copper; it is raised by water or other power, and allowed to fall by its own weight. Several of these mortars are generally arranged in a row, and constitute what is called the *stamping or pounding mill*.

The pounding mills are used altogether in France, for the military service, but the charcoal used is made in open pits, where it is more thoroughly burnt and be-

comes more friable than cylinder coal, which last is too hard to be pulverized sufficiently by the action of the pestles. Each mortar receives about twenty pounds of composition. The charcoal, in small pieces, is first placed in with a quantity of water, and pounded for half an hour, after which the saltpetre and then the sulphur, previously pulverized and sifted, are put in, and the whole well mixed with the hand; and, after being pounded for an hour, it is transferred to the next mortar in the row, and so on, changing every hour. At the sixth or eighth change add a half-pint of water, to guard against explosion. During the last two hours no change is made, in order to allow the composition to form into cake. It is then taken from the mortar, the moisture reduced to four per cent. and then grained.

206. **Dust-Mill.** Sometimes the materials are mixed by placing them in a barrel, to which a rotary motion is given on a horizontal axis. The barrel is lined with raw hide, and small balls of copper are introduced to keep the particles from cohering. Mills composed of turning barrels are called *dust mills*. The materials

are then carried to the *rolling-mill*, where they are incorporated.



207. **Rolling Mill.** This mill consists of an iron or marble platform, upon which two vertical wheels are made to move, by being placed upon the extremities of a horizontal axle, to which motion is given by an upright shaft. These wheels

are of iron or stone, about six feet in diameter, and weighing about five tons each. The materials being placed upon the platform, motion is communicated to the wheels by water or other power, and sufficient moisture is added to enable the materials to form a hard cake. To prevent them from spreading too much upon the platform, a follower, like a plough, is adjusted for the purpose of confining them to the track. Care should be taken at first to spread the materials so as to form a cake of equal thickness throughout, otherwise slight shocks are given to the wheels, and explosions are sure to follow. The wheels revolve about ten times a minute, and after from one to three hours' running they are stopped, the *cake* broken into pieces, and carried to the graining mill.

208. The great danger of explosion to which the rolling mill is exposed has given rise to an invention which has for its object to prevent an explosion in one mill extending to the adjoining mills. This invention consists in placing a tub of water and an inverted funnel over each mill, and connecting a valve which is placed in the bottom of each tub, with a lever, to which the corresponding funnel is attached. These levers are so adjusted and united with each other, that an explosion at one mill, by throwing up its funnel, will cause the water to be discharged from every tub.

The incorporation in the rolling mill is effected much quicker than in the pounding mill, and it is found that it exhibits a greater degree of strength in cannon than powder incorporated in any other way. The rolling mill is used in our country and in England, but the French still retain the pounding mill.

209. **Graining.** When the cakes of powder have been taken to the graining mill, they are passed between grooved rollers, for the purpose of breaking them into fragments, and afterward between smooth rollers to give the degree of granulation required. For very fine grains a second set of smooth rollers is required.

210. **Glazing.** The grains are then freed from lumps and dust by being sifted in fine sieves or bolting cloths. If the powder is to be *glazed*, it is placed in a barrel lined with lead to which motion is given on a horizontal axis; small quantities are introduced at a time, and the grains become polished by friction against each other. The dust formed by the operation adheres to the barrel, and the grains, having been again sifted, are carried to the *drying room*, where they are placed in thin layers upon shelves. This room is generally heated by steam pipes, or stoves so adjusted as to prevent the communication of fire, which is effected by placing the furnaces on the exterior. The heat is kept at about 120° Fahr. for about twelve hours, when the powder is sufficiently dry for packing. Before packing, however, it is again sifted to remove the dust formed in drying. The dust may be worked over again to make inferior powder, or mixed with other composition in the mill.

211. **Effect of Glazing.** When powder has been glazed, it resists the effects of the air and transportation better than when unglazed, but the inflammability of each individual grain becomes less; large charges, however, are more rapidly consumed, when glazed, on account of the freedom with which the flame may circulate through the interstices, and envelop the whole mass.

212. **Size of Grain.** The size of the grains should depend upon the quality of the charcoal, the density of the powder, and the use to which it is to be applied. As powder is more inflammable in proportion to the lightness of the charcoal, any increase of that lightness should be accompanied by a corresponding increase in the size of the grains or the density of the powder, when it is to be used for the same purpose. But when used for different arms, the size of the grain should increase with the calibre. For sporting, the grain should be small; for cannon, larger; and for mining purposes, still larger. The form of the grain is also of some importance, the angular being more inflammable than the spherical.

When the powder has been manufactured as above described, the grains of different sizes are separated from each other by sieves prepared for that purpose; these sieves are six in number, the holes are of the following diameters, viz.:

No. 1	- - -	.12	of an inch.
No. 2	- - -	.10	" " "
No. 3	- - -	.09	" " "
No. 4	-	.06	" " "
No. 5	. -	.05	" " "
No. 6	-	.035	" " "

The first three are marked for "Cannon Powder," the last three for "Small Arms."

The powder for small arms should be more highly glazed than that for cannon.

213. **Packing Gunpowder.** The powder must be packed in well seasoned and substantial white oak casks, of such dimensions that, with one hundred pounds of pow-

der in each, a space of two inches will be left between the powder and the head of the cask when standing on end. The object of leaving this space is that, when the barrels are rolled or turned, the powder will be able to move; this will prevent it from caking in the barrels.

214. **Marking the Barrels.** Before leaving the manufactory, the barrels shall be marked on one head with the name thereof, date of fabrication, and kind of grain, in black. After proof, the proof marks are to be put on the other head, in red, thus:

The marks of the manufactory, year of fabrication. C. P. for cannon powder, or M. P. for musket powder.	}	On one head, in black.
Proved, 18— Initial velocity, in feet. Initials of Inspector's name.	}	On the other head, in red.

215. **Advantages of Graining.** Gunpowder is never employed in the state of a simple mixture of the ingredients reduced to a fine powder, but the mixture is always formed into grains. By this we obtain several advantages.

1st. Grained powder permits the flame to penetrate the mass more easily through the interstices of the grains; a simple mixture, although compressed, also leaves interstices between the particles, but they are not of sufficient size to permit the free passage of the flame, consequently the inflammation can only be communicated to the mass stratum by stratum, as it takes place, though much less rapidly, in the combustion of port-fires, which are composed of the same ingredients as gunpowder, but in a slightly different proportion.

2d. The powder, when grained, does not sift through the cartridge bags, or between the staves of the barrels; the transportation of the powder, and its employment become less dangerous in consequence of its graining.

3d. Grained powder does not absorb moisture as readily as a simple mixture.

4th. Each portion of the mass preserves the requisite proportions of the three ingredients in a better manner. In a simple mixture the proportion will be constantly destroyed by motion: the different ingredients in a barrel would evidently arrange themselves in the order of their densities, consequently the lower strata would contain the denser ingredients in excess, and the contrary with the others.

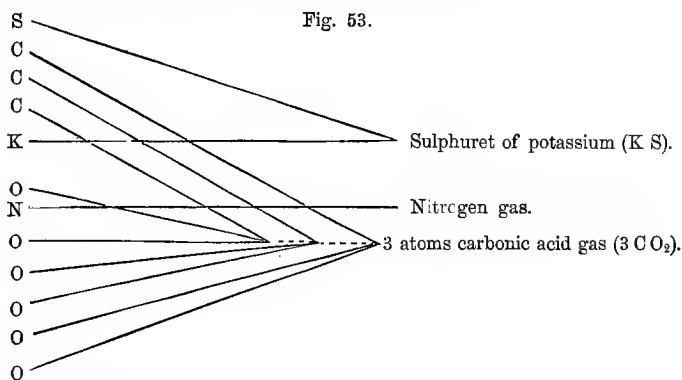
216. **Chemical Definition of the Ingredients.** Gunpowder, as has been shown, is a compound of sulphur, carbon, and nitrate of potassa. The nitrate of potassa is composed of nitric acid and potash; potash is a combination of potassium and oxygen (K O), and nitric acid is oxygen and nitrogen gas combined (N O<sub>5</sub>).

The chemical symbol for sulphur is S, that for carbon is C; the formula for gunpowder in the solid state is



217. **Phenomena attending the Change from a Solid to a Gaseous State.** Upon the application of heat to this solid, the gases (oxygen and nitrogen), in the nitric acid are disengaged from the potash, and the sulphur, having a great affinity for the potassium, decomposes the potash, thereby liberating another atom of oxygen. The oxygen disengaged combines in vivid combustion with the carbon in the proportion of two atoms of oxygen to one of carbon, forming carbonic acid gas. The nitrogen gas

remains independent. The powder has, therefore, on the application of heat, suddenly lost its solid form, and entered into the gaseous state, developing carbonic acid gas and nitrogen gas. The sulphur, united to the potassium, remains in the solid state, in form as a paste, forming a sulphuret of potassium, which is the residuum left in the gun after the combustion. The phenomena attending the change from the solid to the gaseous state are exhibited in the following diagram.



These gases, when first evolved, occupy a space differently stated from one to five thousand times greater than that occupied by the powder in its solid state; and this new form is engendered, and space occupied, with a velocity equal to 5,000 feet per second. The elevation of temperature due to this phenomenon is valued at 2,400° cent., and the tension of the gases at 7,500 times the atmospheric pressure.

218. **Combustion.** The inflammation of gunpowder, the taking fire of all the mass, should be carefully distinguished from its combustion, or change of state from a solid to a gaseous form. Powder does not inflame instantaneously; if it did, no gun could be made strong

enough to resist its force. Its inflammation is gradual and progressive, and in a gun the projectile commences to move, probably, before all the charge is ignited. The development of its force is affected by the proportion of the space which it occupies, to the space around it in the gun. It is found that as this vacant space increases (beyond a certain amount which has been found advantageous, and which will be spoken of further on), the projectile force of the powder greatly decreases, whilst its absolute force or shock seems to increase. Thus, for instance, when a ball is not rammed home, it is not moved by the first portion of the gas evolved, but it remains stationary until nearly the whole force of the charge is developed, when, acting by its inertia against the immense shock of this force, the violent reaction of the fluid takes effect before the ball moves, and bursts the gun. In the same way, a musket whose muzzle has been stopped with mud, or even snow, has been known to burst just behind the obstruction. As a gun is usually loaded, no such shock is felt; the ball moving with the first gas generated, its inertia is gradually overcome, and it furnishes space by degrees as the development of the gas requires it.

219. **Combustion more Rapid in a Closed Space.** Powder is consumed much more rapidly in a space partly closed, than in the open air; thus, in guns, where the flaming gases have no other means of escaping than between the projectile and the sides of the bore, or by driving the projectile before them, the combustion is very rapid, although requiring a definite interval of time.

220. **Rate of Burning.** The rate of burning may be determined by noting the time taken for the flame to travel

from one end of a uniform groove, in a plank or a piece of metal filled evenly with powder, to the other, protecting the flame from the action of winds, &c. The relative rates of two similar kinds of powder may be determined by filling such a groove, circular in form, one half with each kind of powder, and applying a light at one of their points of meeting. Of course, the one that burns past the opposite point of meeting, is the fastest powder. This test is the most satisfactory when applied to small-grained powder, which can be placed evenly in the grooves.

Of the three ingredients of which gunpowder is composed, the sulphur is the most inflammable. We can fuse it and even inflame it (which takes place at 270° Fahr.) without exploding the powder of which it forms a part; but, to do this, it is necessary that the temperature shall be slowly raised to the proper point by the gradual application of heat.

With a spark, produced by the collision of a flint and steel, we do not inflame the sulphur, and if we communicate the fire to the powder by this means, it is not the sulphur, but the charcoal, which first takes fire.

221. **Temperature necessary for the Inflammation of Gunpowder.** The complete inflammation of gunpowder requires that a part of its mass shall be raised to a red heat, or about 600°. We may convince ourselves of this fact by burning hydrogen gas in an eprouvette, in presence of the powder, which will not take fire, or by placing a small quantity of powder in contact with the flame of blazing paper, which, if quickly withdrawn, will not inflame it. The inflammation may be caused by a spark, or any other cause, which suddenly or gradually raises its temperature to the necessary degree.

*is at the lowest temperature?*

222. **Causes that will produce Inflammation.** According to various authors, powder explodes by the collision of iron against iron, iron upon brass, brass against brass, and less readily by copper against copper. By experiments made in England, it also explodes by the shock of bronze and copper, iron and marble, quartz and quartz, lead and lead,\* or when a leaden ball was fired against a pendulum sprinkled with powder; finally by contact with live coals, jets of gas, &c.

Powder brought in contact with a body in an incandescent state takes fire at once and explodes; thus the flint tears off small particles of steel in a state of incandescence, which soon communicate fire to the priming.

223. **Methods in use for Inflaming Gunpowder.** The three methods that are, or have been in use for the inflammation of gunpowder in service are: 1st. By contact with incandescent charcoal, as with the ordinary slow match. 2d. By the flame which accompanies the combustion of a mixture similar to that of gunpowder, as the port-fire. 3d. By a priming of fulminating powder. This last method seems to be, above all others, the most proper to attain the object. Their flame penetrates the mass with the greatest rapidity, almost instantaneously envelops the grains, and communicates to them the high temperature which is necessary to induce their inflammation.

224. **Inspection of Gunpowder.** Before gunpowder is received into service, it should be ascertained that it has been properly manufactured. It may have the required strength and still be incapable of being long preserved,

\*This was shown by placing some powder on a mass of lead, contained in a broken shrapnel, and, striking it with a leaden bullet, the powder was ignited.

and on this account it becomes necessary to inquire into the manner in which the mixing, pounding and other manipulations have been performed, for upon these the powder depends in a great measure for the preservation of its qualities. The grains should be hard, free from dust and of a uniform size. Their hardness is ascertained by trying to crush them with the finger in the hollow of the hand, their freedom from dust by pouring them on the back of the hand or on a piece of white paper, and their equality of size is determined by sieve gauges, or judged by the eye. By the regulations of our service, the powder shall be free from dust, the grains firm, and when fired in small quantities (say about ten grains) on a copper plate, shall leave no spots or foulness. Any spots left after the explosion would indicate too large a proportion of charcoal, which would render it susceptible to moisture, and operate against its capacity of being long preserved.

225. Several causes affect the velocity of combustion. We will notice

**1st. The Mode of Incorporation.** The intimacy with which the ingredients are mixed influences in a great degree the combustibility of the powder; the nature and force of compression modify the density of the grains, thus influencing the velocity of combustion. Perfect manipulation will produce a stronger and better powder with bad proportions, than imperfect manipulation will produce with good; this is especially apparent when gunpowder is used in large quantities in heavy ordnance. Powder of great density also strains the gun less than less dense and consequently quicker powder, while it produces the maximum of useful effect.

**226. 2d. The Dryness of the Powder.** This increases the rapidity of combustion in a great degree. Thus we may easily conceive that the vaporization of water absorbs a great quantity of heat which diminishes the temperature of the gases and consequently their tension. The humidity also occasions agglomerations of the grains, which do not leave sufficient channels for the free passage of the inflamed gases; finally, it causes an efflorescence of the nitre on the surface of the grains, forming a crust which inflames with difficulty.

**227. 3d. The Ratio of the Charge.** The heat developed increases with the charge, and, as the velocity of the gases increases with their temperature, it is therefore evident that a heavy charge is consumed proportionally quicker than a small one; it is also true that the loss of heat absorbed by the surface of the bore is much less sensible when the charge is great than when it is small, that is, the quantity absorbed is proportional to the surface or the square of the calibre of the gun, whilst the heat developed increases as the cube of the calibre.

Finally, several properties of powder, which accelerate combustion, have no effect when the charge is very small; thus, for example, the influence of the size and shape of the grain, which determine the free circulation of the flame through the mass, does not come in play when the charge is small, which, whatever may be the granulation of the powder, is almost instantaneously enveloped in flame.

**228. 4th. The Resistance to be overcome.** When the projectile offers a great resistance, it is not so quickly displaced as when the resistance is slight; its motion in

the first instance is then less rapid, and it evidently follows that the combustion takes place in a space more confined as the resistance to be overcome is greater. The smaller this space is, the more the heat is concentrated, the higher the temperature of the gases is raised, and consequently their velocity is increased, the inflamed gases have a less distance to expand through, and there follows from all these causes a train of effects all of which accelerate the combustion of the charge.

If the projectile offers but a slight resistance to the action of the motive force, this last will displace it during the first instants of its development, with a velocity proportionally greater as the resistance of the projectile is less. It follows that too light a projectile has the same inconvenience as too short a bore, for it shortens the duration of the action of the gases.

The resistance which the projectile opposes to the motive force is due to its friction against the surface of the bore, and its inertia, to which it is necessary to add a portion of its weight when the gun is fired at an elevation. This friction and inertia increase in the ratio of its weight, and the resistance which the gases have to overcome is therefore dependent upon this last.

The initial velocities obtained with the same gun and same charge, but with projectiles of different weights, are nearly inversely proportional to the square roots of the weights; whence it follows that the useful effects increase as the weights.

It is generally conceded, in practice, that the same charge of the same powder always produces the same velocity, whatever may be the angle of elevation; but it must be admitted, all other things being equal, that

the initial velocity of the projectile, and therefore the useful effect of the charge, increases with the angle of projection.

229. **5th. The Place where Fire is Communicated to the Charge.** When a quantity of powder is contained in an enclosed space, all the sides of which offer an equal resistance, it is evident that the inflammation and complete combustion will be the quickest possible when the fire is applied to the centre of the charge.

In cannon, however, the force developed does not meet with the same resistance in all directions; the projectile yields as soon as sufficient force acts upon it, and, as the combustion of powder requires a definite interval of time, it follows that a great part of the charge is not consumed until after the displacement of the projectile. The combustion is completed in a much greater space than that occupied by the charge, and the tension and velocity of the gases will be much less; besides, the unconsumed grains are mingled with the current of gas already developed, and driven forward from the place where the heat is most intense; and it necessarily follows that the complete combustion of the charge is retarded; therefore it appears to be evident that the combustion will be more rapid in proportion as the displacement of the projectile is slower.

Now, the position of the vent may influence the time required to displace the projectile. Thus, for example, with the regulated vent, it is the upper part of the charge, that which is in contact with the interior orifice of the vent which first takes fire; the inflammation is communicated to the parts adjacent, and promptly reaches the projectile; the inflamed gases, endeavoring

to escape above this last, displace it; it follows that, in this position of the vent, the space in which the combustion takes place, increases from the first, and that it is completed in a space much greater than that at first occupied by the charge.

If the vent be pierced in the direction of the axis, its interior orifice is at the centre of the bottom of the charge, and the inflamed gases do not come into immediate contact with the projectile until after the complete combustion of the charge has taken place. The projectile cannot take up motion until this occurs, unless motion is communicated to it by the unconsumed powder still interposed between it and the gases already developed; but this transmission requires a certain time, and it is probable that the combustion will be so rapid that the displacement of the projectile will be scarcely sensible before the combustion of that part of the charge in contact with it. It would appear from this reasoning that the direction of the vent, in order to produce most rapid combustion, ought to terminate at the centre of the bottom of the charge, or in the direction of the axis.

Experiments made in France in 1830, have proved the truth of this conclusion. These experiments were made at three different schools of artillery, as nearly as possible under the same circumstances, with three guns of the same calibre, in which the vents were pierced; for the first, in the prolongation of the axis of the piece; for the second, in a line inclined  $30^\circ$  to the axis; for the third, at an angle of  $70^\circ$  with the axis.

The results of these experiments were: 1st, That the last mentioned position of the vent produced the least recoil, and that it had also an advantage over the other

two positions with respect to range and accuracy of fire. 2d, That this position did not cause any sensible alteration in the gun, whilst the enlargement of the bore was considerable in those guns in which the vent was in the axis, or formed an angle of  $30^\circ$  with the axis.

The great indentations which have been observed in the pieces with the vent in the axis, or inclined to it at an angle of  $30^\circ$ , can only be explained by supposing a more rapid combustion of the powder in them than in those having the vent more inclined from the axis, for those injuries which are due to the expansive action of the gases ought necessarily to increase with the tension of these gases.

230. **6th. The Material of which the Gun is composed.** The qualities of the gun, as a good or bad conductor of heat, lower more or less the temperature of the gases, and differently retard the duration of combustion. It is shown by experiment that iron guns give longer ranges than those of bronze, probably because bronze is a better conductor of heat.

231. **7th. The Size and Form of the Grain.** We have already stated that the granulation of gunpowder renders its combustion more rapid, because it permits the free circulation of the flames through the mass, which they almost instantaneously penetrate. If the powder be not grained, and, in consequence, the interstices between its particles are small, the flame can only penetrate the mass little by little, and the combustion ensues in successive strata. We see examples of this in port-fires, which, notwithstanding their quick composition burn from five to ten minutes; in rockets, which raise themselves to a considerable height before the combustion is

finished; or in the fuze of a shell, which burns long enough to permit it to reach the object before it communicates fire to the bursting charge which is contained in the shell.

The size and regularity of the interstices determine the greater or less difficulty of the passage of the flame, which communicates the inflammation to the mass in the direct ratio of the surface of the grains which it encounters; thence it follows that the size and form of the grain should exert a great influence upon the velocity of combustion.

The form of the grain is either angular or spherical; each of these forms gives the grain certain properties, some of which are favorable, others injurious, to the rapidity of combustion. The surface of grained powder, and the density of its mass is, for equal size of grain, greater in angular than in round powder. These two circumstances favor the rapidity of inflammation; the sudden checks received by the flame cause it to surround the grain, while it is more or less reflected from the glazed and curved surface of round powder.

232. **8th. The Influence of Glazing.** The glazing of the grains facilitates the rapid transmission of the flame through the mass, but it impedes the penetration of the inflamed gases into the interior of the grains, and considerably diminishes their combustibility. This last effect is readily explained: first, because their polished surfaces, the pores of which are partly stopped up, reflect the inflamed gases, and do not permit them to act readily; second, because the greater density of the grains which have been glazed renders the penetration of the gases into the interior of the grains more difficult.

When the quantity of powder is small, and in consequence the flame is transmitted with facility through the whole mass, glazed powder will be slower than that which is rough; but when the charge is heavy, the rapid penetration of the gases through the mass, so that the whole is completely inflamed before the displacement of the resistance, may shorten the total duration of the combustion, and the whole be consumed in less time than an equal quantity of rough powder.

In the *eprouvette*, glazed powder has a marked disadvantage. In cannon, on the contrary, particularly those of heavy calibre, glazed powder is always superior.

**233. Character of the Action of the Gases.** The action of the gases upon the projectile does not appear to be similar to a pressure, but is rather to be considered as a series of impulses or shocks; for these gases being possessed of a greater velocity than the projectile, particularly at the instant of their evolution, have a constant tendency to outstrip it, and therefore impel it with an intensity which depends on the relative velocity of the two bodies. The transmission of this excess of velocity from one to the other is by infinitely small degrees, and their action ceases when the velocities become equal. This velocity accumulated in the projectile, is not the product of the instantaneous effort and pressure of the gases, but rather the sum of the efforts which they have exerted against it, thus the gases evolved by the combustion of the charge acting constantly upon the projectile during its passage along the bore, impress upon it an accelerated motion.

It is easy to conceive the existence of an explosive body which, during the act of explosion, shall evolve

the whole of its gases at once. Fulminating silver approaches this mark; wherefore, though no gun can be made strong enough to restrain them, they are contemptible as projectile agents. In point of fact, in proportion as an explosive body evolves its gases suddenly, so does the force of it approach the nature of the force displayed by *liquid* pressure. If about five grains of gunpowder, made up into a small cartridge, be fired in a common wine bottle corked, as can easily be done by an electrical device, the bottle would infallibly be shattered, and the fragments driven about with dangerous velocity; yet the force exerted on the sides of the bottle is much less than that produced by filling the bottle with water, inserting a tapering cork, and striking the latter with a sharp blow of a mallet; the latter experiment may, however, be performed with impunity, the operator holding the bottle in his hand.

234. **Harmlessness of Non-elastic Force.** A still stronger exemplification of the harmlessness of non-elastic force, considered as to its projectile agency, has been afforded by the bursting of the cylinders of various hydrostatic presses employed in the launch of the Great Eastern. The cylinders were rent as though made of wax, yet the fragments were not driven about, simply because the whole amount of force capable of being exerted by water pressure was exerted at once, water not being elastic, or so trivially elastic that we need not take cognizance of it. It will be perceived from this that the essential characteristic that must be possessed by the propelling force is *elasticity*, which may be defined as the gradual putting forth of motive force within limits.

A very quick powder almost instantaneously gives a

violent impulse to the gun and projectile, displaces the latter, and drives it out of the gun; but the motive force, being suddenly developed, decreases very rapidly when the gases expand into a greater space, become less dense, and lose their caloric.

**235. Advantage of Slow Powder in large Charges.** A slow powder produces a more tardy displacement of the projectile, and impresses upon it as well as the gun a less violent impulse; but the projectile, moving less rapidly, is a longer time subjected to the action of the gases; and this effort itself decreases less rapidly, because the combustion of the charge is only completed during the passage of the projectile along the bore, which partly compensates for the loss of tension which the accelerating force has experienced by the decrease of density, and the diminution of the temperature of the gases already evolved.

If, then, the projectile does not too readily yield to the action of the gases, and the gun is of sufficient length to allow the time, during which the action continues, to compensate for the less intensity of the slow powder in the first instants, it may easily happen that the projectile has, on leaving the gun, an equal or even a greater initial velocity than a quick powder would have communicated to it. We must admit that the initial velocity is nothing but the sum of the partial accelerations of velocity which the projectile has received, and that a great number of slight accelerations, which slowly decrease, may equal or even exceed a smaller number of accelerations, much greater in the beginning, but rapidly decreasing.

Slow powder should be superior to quicker powder

when the charge is heavy, the resistance to be overcome considerable, and the gun long. Acting upon this now well established principle, Captain Rodman has experimented with his gun of fifteen inches calibre, mentioned in chapter II., with powder of grains of great size, as well as with cartridges formed of cakes of powder perforated with holes to admit the flame. The object evidently is to modify the celerity of combustion so as to develop gradually the force of the charge. The effect is to increase the range as well as to relieve the strain upon the gun. The conclusions that are arrived at from Captain Rodman's experiments, as well as from other experiments of a similar nature, go strongly to show that each calibre requires a peculiar size of grain in order to produce the best results, the size of grain required to produce these results increasing uniformly with the calibre.

**236. Advantage of Quick Powder in Small Charges.** In a mortar, the time during which the motive force acts upon the projectile is necessarily of short duration, at least when the resistance to be overcome is not very great. For these pieces it is necessary that the motive power should be rapidly developed, or, in other words, that the powder should be quicker proportionally as the projectile is lighter.

In small arms, the ball yields to the slightest development of the motive force; if, therefore, the projectile be not driven rapidly along the bore, the period of contact of the gases with the sides of the bore is prolonged, a sensible loss in the temperature of the gases follows, and consequently a great diminution of their living force. The powder that produces the maximum effect in small arms should therefore be quick.

237. **Maximum Charge.** The determination of the charge which produces the maximum effect is intimately connected with the preceding considerations. Thus there is a relative charge for all guns which produces the maximum velocity of the projectile, and this charge increases with the length of the gun; beyond this maximum the velocity decreases with the increase of the charge, but the recoil of the gun always increases with the charge. ✕

Major Mordecai says, the charge of two-thirds the weight of the ball may be considered the maximum charge, beyond which the velocity of the ball does not increase with the quantity of powder. According to Colonel Duchemin, the velocity produced by the maximum charge is to that produced by half of that maximum as fifteen to fourteen. The latter proportion (one-third the weight of the ball) should, therefore, never be exceeded.

238. The last cause that we shall cite as affecting the velocity of combustion is, THE SHAPE OF THE PLACE WHICH CONTAINS THE CHARGE. If the projectile be in contact with the charge, the gases will be of the greatest density, highest temperature, and greatest possible tension; but if a vacant space exist between the charge and the ball, the first impulse of the gases against the projectile will be extremely violent, but, since this last is not yet in motion, there is a very sensible loss of useful effect uselessly employed against the surface of the chamber, or bottom of the bore, which is violently strained by the gases which rebound from the projectile. The vacant space, therefore, diminishes the propellant force of the charge; for this reason, when

firing reduced charges from chambered guns, it has been shown that the range will be increased by filling this space with a block of wood or other substance.

239. **Effect of the Size of Chamber.** The size of the orifice of the chamber exerts an influence upon the initial velocity, and this influence is generally greater in proportion as the orifice is smaller, at least to a certain limit. For this reason cylindrical chambers, which are narrow and deep, give greater ranges than those which are wide and shallow. The most advantageous proportion between the length and diameter of chamber appears to be three to one. As the length of the gun increases, the influence of a chamber diminishes, until it becomes insensible at a length of about twelve calibres, and a charge of one-sixth the weight of the projectile.

240. **Proof of Powder.** When the powder has been inspected, as before described, its strength is proved by firing a charge from a small mortar called an *Eprouvette*.

241. **Eprouvette.** This piece is so cast that, when placed upon its bed, its angle of elevation is fixed at  $45^\circ$ . The chamber is cylindrical, and made to contain a charge very small in proportion to the weight of the projectile. The bore is very short, and the projectile is a solid ball. This proportion between the charge and the ball produces so little velocity in the flight of the projectile that there is no necessity of taking into consideration the resistance of the air.

The angle of elevation is fixed at  $45^\circ$ , because this is the angle of greatest range in a vacuum, and, the velocity being so small, we may consider the flight as taking place in a vacuum. It is evident that, firing under the angle of greatest range, the variations of initial velocity,

produced by different strengths of gunpowder, occasion greater variations in the range than would be produced under any other angle of fire.

In our service the eprouvette and ball are of cast iron, the chamber is made to contain one ounce of powder, the ball weighs 24 pounds, and the length of the bore is twice that of the calibre. The platform for the eprouvette should be a block of oak timber established on a foundation of masonry, with which it is connected by strong bolts; to this block, the iron bed plate is fixed by the three bolts provided for that purpose, the plate being also let into the wood about 1.5 inch to avoid bending the bolts. The ground where the balls are to fall should be free from stones, and not too hard.

The powder in each barrel is proved. For this purpose a sample of about three and a half ounces is taken from each, this sample is poured into a tin canister marked with a number, a corresponding one to which is inscribed with chalk on the barrel; from these samples the charges for the eprouvette are weighed on the proving ground, as they are required.

The eprouvette being washed clean, and dried by firing a scaling charge, is placed in its bed in a vertical position, in which it is supported by a wedge; the vent is stopped by a copper wire having a shoulder to prevent it from projecting into the chamber, and the charge of powder is introduced through a long funnel which is supported on the bottom of the bore, at the mouth of the chamber; the ball is then carefully lowered down, and the mortar placed on its bed, care being taken not to jar it roughly; it is primed with a small strand of quickmatch, and fired without delay.

Two charges are fired in this way from each sample of powder, and, if the two ranges differ more than twenty yards, a third charge is fired, and the two nearest ranges are used in obtaining the mean range. The mortar is scraped and wiped after each discharge, and it is washed and dried, as at first, after about eight shots.

242. **Ranges by Eprouvette.** The general mean range of new powder, proved at any one time, must be not less than 250 yards, but no powder ranging below 225 yards is received. Good cannon powder generally ranges from 280 to 300 yards, and small grain powder from 300 to 320 yards.

243. **Ranges condemning as unserviceable, &c.** The powder in magazines is considered unserviceable if it does not range 180 yards. It is then laid aside for salutes, practice with blank cartridge, &c. When it becomes less than 150 yards, it is condemned to be sold or re-manufactured.

Although the above is the established mode of proof for government powder, it cannot be disguised that a very imperfect test of the relative projectile force of gunpowder is thereby afforded. Slight variations in the density of the powder, which would but little affect its strength when fired in large quantities, produce great difference in the proof range; and variations in the size of grain cause still greater irregularities in the range, the powder being in other respects the same. In general, gunpowder of *small grain and low specific gravity* gives the highest range in the eprouvette, whilst experiments with the *Ballistic Pendulum* have shown that the greatest initial velocity in a shot, from a heavy gun, is produced by powder of *great specific gravity and of coarse grain*.

244. **Ballistic Pendulum.** Figures 54 and 55 represent the Ballistic and Cannon Pendulums, erected at the Washington Arsenal, for the purpose of experimenting on gunpowder, determining initial velocities, &c. The gun pendulum consists of a gun slung on a horizontal axis in such a way that the axis of the gun passes through the centre of oscillation of the pendulum thus formed, and is, when the gun is fired, perpendicular to the vertical plane passing through the axis of suspension. The axis then receives no shock, and, knowing the time of oscillation of the pendulum, a formula is deduced, by which the initial velocity of the shot, or the space passed over in the first second of time after it leaves the bore, is determined. The ballistic pendulum consists of a hollow cast-iron frustrum of a cone, slung in the same way as the gun, with its axis in the same horizontal plane as the axis of the gun when at rest. This cone is filled with sand packed in baskets or cases made of strong leather stretched over iron frames, the frame consists of two wrought-iron hoops, connected together by ribs of the same material; each hoop is made in three segments, and the corresponding segments of the two hoops which form one frame, are connected together, each pair, by three ribs of square iron welded to the hoops. The leather which covers these frames is brought over the outer faces of the hoops, and secured there by rivets, the sections of each hoop being connected together by the leather covering only. Four of these cases are placed in the pendulum *block*, and, forming what is called the *core*, are destined to receive the ball fired from the gun pendulum. A graduated arc under each of these pendulums shows, by means of a sliding

Fig. 54.

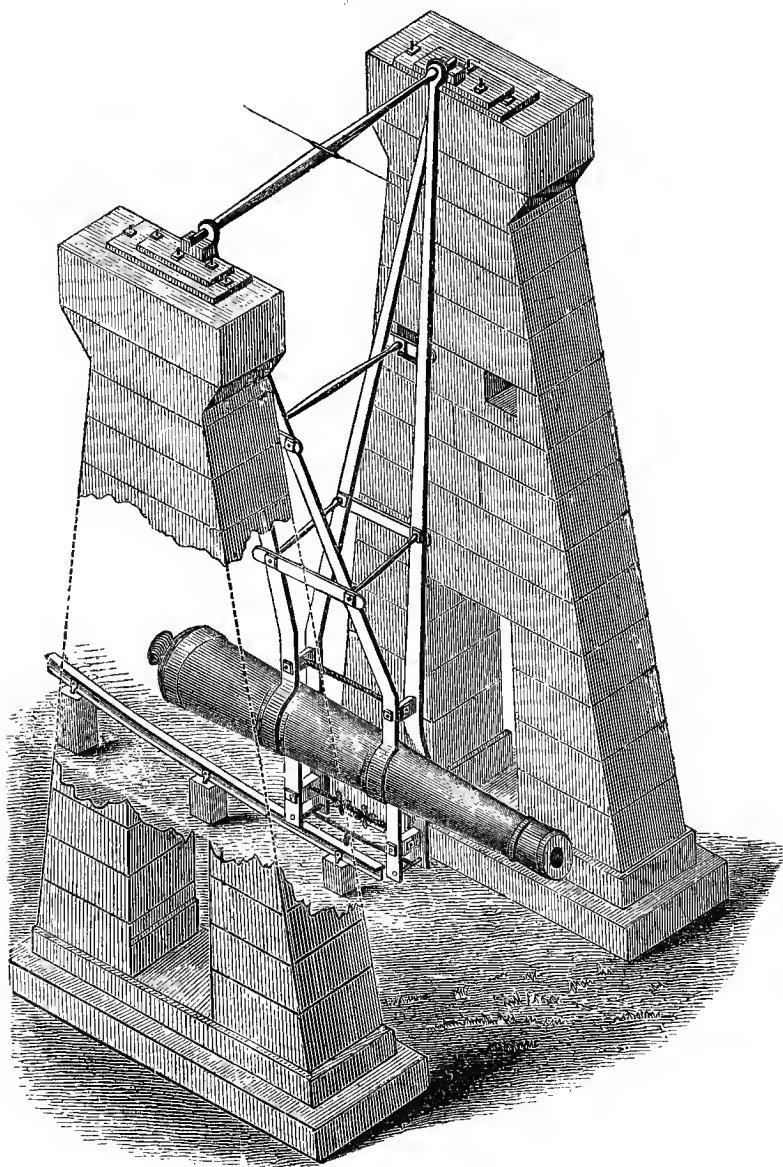
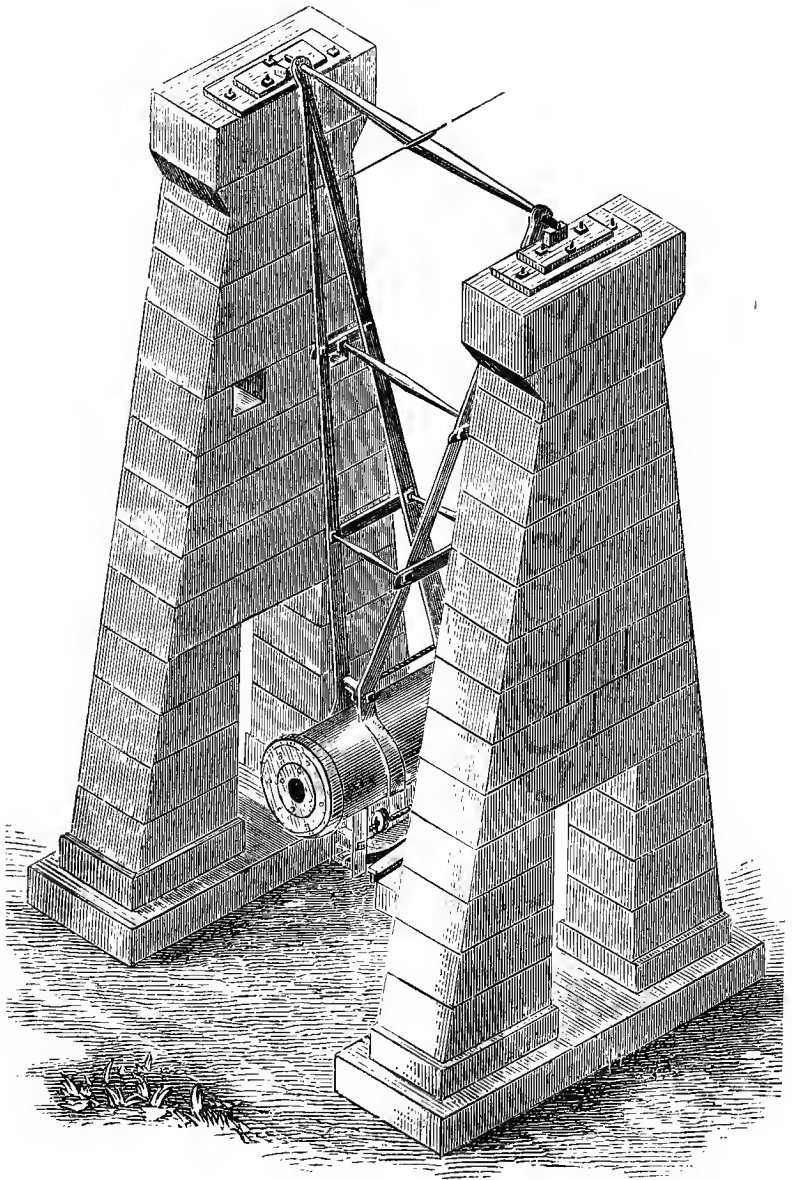


Fig. 55.



pointer, the angle through which they recoil when the gun is fired. This angle is, of course, the element from which the initial velocity is determined.

245. **Distance between the Pendulums.** In order to ascertain the least distance at which the pendulum could be placed from the gun without being too much affected by the blast, a 24-pdr. gun was suspended by a rod 20 feet long, and a disk, 34 inches in diameter, was attached to the muzzle. Against this disk blank cartridges were fired from another gun, a screen with a hole of 12 inches diameter being interposed between the gun and the disc. In this manner it was ascertained that, at the distance of 48 feet from the muzzle of the gun, the pendulum would be but slightly affected by the blast, and, in the practice with the pendulums, it was determined to place the axes of the two pendulums 55 feet apart. In order to intercept the blast of the gun as much as possible, a fixed screen of 2-inch oak plank is placed 17 feet in front of the face of the pendulum block, having a hole in it 12 inches in diameter for the passage of the ball.

These pendulums may be used together or separately; but when used together they serve as checks on each other, and great accuracy has been attained in determining the force of powder, as well as many other points important to the science of artillery, such as the proper size of the charge, its form, the proper position of the vent, the best length of bore, thickness of metal, effect of wads and sabots on the force and accuracy of the shot. To Benjamin Robins is due the invention of these pendulums, which, under the improvements of Hutton, have made such a great stride toward perfection in the determination of the strength of gunpowder.

246. **Loss of Force by Windage.** Some experiments were made by the ballistic pendulum, from which an estimate may be formed of the loss of force by the windage of a ball: thus, four pounds of powder was found to give to a ball, without windage, nearly as great a velocity as is given by six pounds to a ball having the windage of .14 inch; or, in other words, this windage causes a loss of nearly *one-third* of the force of the charge.

Some experiments also show that the loss of force, by the escape of gas through the vent, is altogether inconsiderable, when compared with the whole force of the charge or with other unavoidable variations which affect the velocity of the ball.

Experiments also show that no influence of the force of the charge can be attributed to the use of percussion primers for igniting the powder.

247. **Effect of Junk Wads.** In experimenting on the use of junk wads, it is found that the velocity of the ball is somewhat less than when fired with a grommet wad, indicating perhaps that the motion of the ball in the bore is more impeded by the friction of the wad than it is accelerated by the slight additional force which is developed in the charge by reason of the increased resistance. There can be little doubt that the wad diminishes the velocity of the ball very nearly in the proportion of the increased weight. Experiments which were afterward tried on the effect of wads in causing the deviations of the ball, show conclusively that the use of hay or junk wads is decidedly injurious to the accuracy of fire, and that, when a wad is required to hold a ball in its place, it should be made as light as possible,

in the form of a grommet. In these experiments it was found that the accuracy of fire was not affected by a sabot, or a hay wad, placed between the powder and ball; a result of great practical value, since, by this use of the wad or sabot, we are enabled to increase the durability of guns, and especially of brass guns, by changing the position of the ball, without impairing the accuracy of fire.

248. **Effect of varying the Length and Diameter of Cartridges.** Experiments were made on the effect of varying the length and diameter of the cartridges, from which it appears that the force of the charge is vastly reduced when the diameter of the cartridges is such as to entirely fill the diameter of the bore. This effect is readily understood when we consider that, in this case, the flame is communicated to the front part of the charge only by penetrating through the mass of powder; the ball must, therefore, be a good deal removed from its first position before the whole of the charge becomes inflamed, and, consequently, the gaseous fluid, expanding in a larger space, has its tension proportionally reduced. The advantage, in point of force, of the cartridge of reduced diameter was established, and this circumstance assumes great practical importance when taken in connection with another fact developed by numerous experiments in France, viz.: *that by reducing the diameter of the cartridge, the strain on the gun may be greatly diminished.*

In order to prevent the rapid destruction of brass siege guns, which is caused by the use of large charges, Captain Piobert proposed, in a paper written in 1833, to increase the space in rear of the ball by diminishing

the diameter of the cartridge, or by interposing an elastic wad between the powder and the ball. Numerous experiments on the relative injury to brass guns, by using the common and elongated cartridge, have fully realized Captain Piobert's anticipations, by showing that whilst the increase of diameter in the gun is much diminished by the use of the long cartridge, the force of the charge, in its action on the ball, is not lessened, but, in many cases, increased, and, to effect this object, it has not been found necessary to make the cartridges of an inconvenient length.

The most full and careful experiments which have been made on this subject, are those made at Metz, the general result of which was, that by reducing the diameter of the cartridge for the 24-pounder gun (the bore of which was six inches diameter) from 5.5 inch to 5.15 inches, which increased the length of the cartridge about two inches, the enlargement of the area of the section of the bore (produced by four rounds, with a charge of half the weight of the ball) was reduced *four-fifths*, whilst the initial velocity of the ball, as before stated, is somewhat increased; and the result is confirmed by numerous experiments with other large charges.

This effect of increasing the length and diminishing the diameter of the cartridge, seems to admit of an explanation similar to that which has been suggested with regard to the operation of the charge when the cartridge is of the whole size of the bore. For, in the present case, the flame produced by the combustion of the first or hinder part of the charge, expands rapidly in the empty space above the cartridge; its tension and the consequent strain on the gun before the ball is moved,

are, therefore, much less than in the ordinary case of a larger and shorter cartridge. At the same time, in consequence of this rapid expansion of the flame, it is communicated more quickly to the front part of the cartridge than when it has to pass through the mass of powder; and so much the more quickly in proportion as the transmission of the flame through the powder is more difficult, or as the powder is more dense, and the charge greater. Consequently, the complete inflammation and combustion of the whole charge, producing the final velocity of the ball, take place under these circumstances in a smaller space than before, although that space is sufficiently great to reduce very much the intensity of the action of the powder on the sides of the bore.

Be the explanation what it may, the facts are considered, in the French service, to be so well established, that the principle of reducing the diameter of the cartridge is adopted for all siege and garrison guns.

249. **Effect of Reducing Windage.** In considering a projectile agent, the first desire is to obtain velocity for the ball, the next in importance is to relieve the gun from undue strain; it has been shown that the reduction of the diameter of the charge effects both these objects. These objects, however, can be still further attained by the reduction of the windage of the ball. It is well known that a reduction of windage increases range, but it appears, from experiments made by Major Peter Hagner, of the ordnance department of the army, that *a reduction of windage reduces the strain on the gun.*

Major Hagner was engaged in investigating the strain produced upon a gun by different kinds of powder; the

piece used in the experiments was a plug eprouvette, the plug of which, retained by spiral springs, was forced out a certain distance to the rear by the force of the charge, showing, by the extent of pressure exerted against the springs, the power that was exerted to strain the gun. With the same powder, it was noticed that a slight difference in the windage of the ball produced a very marked difference in the strain on the gun, as shown by the plug, as well as in the range of the ball, which was always noted. This led to a series of careful experiments in order to substantiate fully the singular phenomenon exhibited, for, unlike what would have been expected, it was shown that, as the windage increased, *up to a certain amount*, the strain upon the gun also increased.

250. The following table represents the results of these experiments:

Eprouvette measuring 5.655 inches diameter of bore.

Sizes of balls, diameter 5.63 inches, 5.535 inches, and 5.485 inches.

Weight of balls twenty-four pounds.

Charge of powder, 1 oz.

Position of centre of gravity, in centre of ball in every case.

KIND OF POWDER.	AV. RANGE IN YARDS.	AV. PRESSURE ON PLUG IN LBS.	AV. PRESSURE PR. SQUARE INCH IN LBS.	DIAMETER OF BALLS.
Dupont No. 30.	288	301	1,179	5.63 in.
“ “ “	92	331	1,297	5.535 in.
“ “ “	52	207	811	5.485 in.

It will be perceived from this that, with a windage of .12 inch, the pressure per square inch was much increased,

while the range was reduced to one-third of what it was with a windage of .025 inch.

Again, increasing the windage to .17 inch, it will be perceived that the pressure was reduced, but the range was also reduced to one-sixth, nearly what it was with a windage of .025 inches.

251. We can take then, as an established fact, that increasing the windage up to .12 inch, increases the strain on the gun, while it reduces the range very considerably; but that a greater windage than .12 inch tends to relieve the strain upon the gun, but diminishes the range very sensibly. It is evident from this that the strain upon our guns in service might be much relieved by reducing the windage of our shot, which is now allowed to range between .1 inch and .14 inch. The great advantage, also, of the increased range would repay any increased trouble and expense in the manufacture.

252. The effect exhibited in the above table, is to be accounted for in the following manner: The strain on a gun is due to the resistance that is offered by the projectile to the expansion of the gases on the ignition of the charge; the greater this resistance, the greater will be the effort to burst the gun; in other words, the more rapidly the projectile takes up its progressive motion, the less will be the strain exerted upon the gun. Now, if the diameter of the ball be such as to fill up the entire diameter of the bore, the gases will direct their whole force to propel the ball toward the muzzle, and in this way the pressure upon the gun will be the soonest relieved, and the strain will be the least possible. If, however, the ball does not fill up the entire

diameter of the bore, but an opening is left between the upper hemisphere of the ball and the bore, the gases will not exert all their force to propel the ball toward the muzzle, but a portion of them will find vent through the windage ring, thus exerting a force on the top side of the ball, pressing it down on the lower side of the bore, and increasing its resistance to the propelling force by the friction generated through the means of this pressure: the resistance to the expansion of the gases is thus increased, and the consequence must be an increased strain upon the gun.

**253. Effect of the Escape of Gas through Windage Ring.**

The intensity of the friction generated by the escape of gas through the windage ring is not generally estimated at its true value; an instance that is known to have occurred in practice, will convey some idea of its power. A musket was loaded with a spherical ball, the windage being considerable, and the ball not being in close contact with the charge when fired; on discharging the piece, the ball, instead of proceeding out through the muzzle, tore a passage for itself through the under part of the barrel, coming out just below the middle band; the pressure of the gas, rushing through the windage ring, was so great that the metal of the barrel could not resist it, and was forced to yield to the violence of the pressure. It is this pressure which, increasing the resistance to the expansion of gases, increases the strain upon the gun.

**254. Proof of Gunpowder.** Returning to the subject of proof of gunpowder, we find, by comparing the results of the proofs by the eprouvettes with those furnished by the cannon pendulum, that the eprouvettes are

entirely useless as instruments for testing the relative projectile force of different kinds of powder, when employed in large charges in a cannon. Powders of little density or of fine grain, which burn most rapidly, give the highest proof in the eprouvettes, whilst the reverse is nearly true with the cannon. Nor do these instruments assign any superiority to powder which is well incorporated, over powder of the same kind, in other respects, which has been very imperfectly worked; on the contrary, they all give results with the powder incorporated by fifteen minutes' work, equal or superior to those furnished by the same powder worked ninety minutes.

255. **Use of Eprouvettes.** The only real use of these eprouvettes is, to check and verify the uniformity of a current manufacture of powder, where a certain course of operations is intended to be regularly pursued, and where the strength, tested by the means of any instrument, should, therefore, be uniform; but as a means of proving gunpowder received, as it is in our service, from manufactories pursuing different processes, the eprouvettes may be pronounced worse than useless, since they may lead to erroneous results.

The results with eprouvettes correspond generally with those given by the 8-inch mortar with a charge of 12 oz., by the one-pounder gun pendulum, and by the musket pendulum, in which, as in all cases where small quantities of powder are used, rapidity of inflammation is the most influential element of strength. The conclusion then is, that the only reliable mode of proving the strength of gunpowder is to test it, with service charges, in the arms for which it is designed; for which purpose the ballistic pendulum, and Navez's machine

(which will be described further on) are perfectly adapted.

256. **Correct Results obtained with the Six-pounder Gun Pendulum.** Although the present tendency to the use of cannon of very large calibre would make the proof by the pendulums more satisfactory if a 32-pounder were used instead of a piece of smaller calibre, still it does not seem to be necessary to resort to those heavy guns for obtaining a correct indication of the relative force of different kinds of powder. We see, indeed, that such an indication is not given by a one-pounder gun, but experiments at Metz have shown that the 12-pounder gun classes the powders in the same order of strength as the 24-pounder; and further experiments in the United States have shown that the 6-pounder field gun classes the various species of powder in the same order, and with nearly the same degree of relative force as the gun of larger calibre. As the use of the large ballistic pendulum is difficult, slow, and expensive, and as the indications furnished by the recoil of the cannon pendulum correspond with those given by the ballistic pendulum, it is proposed, for the usual proof of gunpowder, to make use of the cannon pendulum alone, employing a gun of the smallest calibre which will give correct results, and firing the balls into a bank of earth which would not make them unfit for ordinary service.

257. **Initial Velocity.** In the 24-pounder gun, new cannon powder should give, with a charge of one-fourth, an initial velocity of not less than 1,600 feet per second to a ball of medium weight and windage.

258. **Proof of Powder for Small Arms.** For the proof of powder for small arms, the small ballistic pendulum

is a simple, convenient, and accurate instrument. The cost of the apparatus might be very much reduced, without impairing the accuracy of the results, by dispensing with the musket pendulum, which is the most costly part of it, and simply firing the ball into the ballistic pendulum block, from a barrel set in a permanent frame. The initial velocity of the musket ball of .05 inch windage, with a charge of 120 grains, should be

With new musket powder, not less than 1,500 feet.

“ “ rifle “ “ “ “ 1,600 “

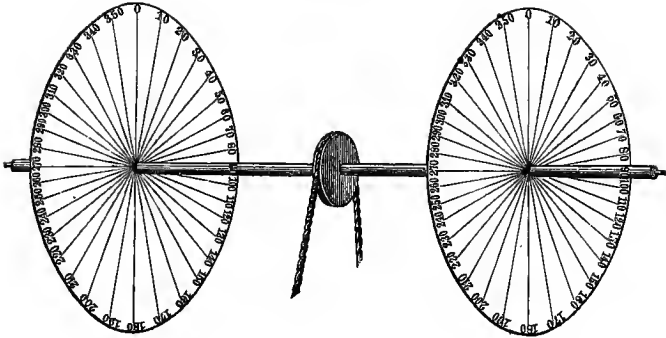
“ fine sporting “ “ “ “ 1,800 “

259. **Capacity for Resisting Moisture.** Although the projectile force of gunpowder is the most important quality to be attended to in the proof and inspection, its capability of being long preserved without much deterioration, and of resisting the effects of such exposure as it is subject to in service, must be regarded as of little less importance. This quality should, therefore, be tested either by comparing the quantity of moisture absorbed, under similar circumstances, by the powder which may be under trial, and by other powder of approved good quality; or by the application of a simple chemical test of the purity of the nitre, as it is on this circumstance chiefly that the capacity of the powder to resist the action of a moderate degree of moisture depends.

260. **Rotary Machine.** The initial velocity of gunpowder has been tested by a machine represented at figure 56, called the rotary machine.

Two disks of thin pasteboard, about six feet in diameter, are fixed perpendicularly upon a horizontal axis which passes through their centres, and is twelve feet in length between the disks. The disks are divided into

Fig. 56.



degrees by radii, drawn from their centres in such a manner that those of the same degree shall lie in the same plane passing through the axis of the machine. An axle, with a large fly wheel and drum upon it is placed at the same height and parallel with the first, and the two are united by an endless chain.

A cord having been wound upon the drum of the second axle, is passed over a pulley, elevated 30 or 40 feet above the ground, and a weight attached. At first the motion communicated to the machine is accelerated; but it finally becomes uniform or nearly so, and the time of one revolution is observed. A gun is then placed in the vertical plane of the axis, and fired in a direction as nearly parallel to the axis as possible. The perforations in the two disks give at once the angular distance between them. Representing this by  $E$ , and the time of one revolution of the machine by  $T$ , we shall have the time which elapses during the passage of the ball between the two disks by the following proportion:

$$360^{\circ} : E :: T : \frac{E T}{360^{\circ}}$$

Now, if we divide the space between the disks (12

feet) by the time, we shall have the velocity of the ball equal to

$$\frac{12 \times 360^\circ}{E T}$$

261. **Navez's Machine.** It is evident that if any machine can be produced for measuring the flight of projectiles, and can be indiscriminately applied to every gun used as it is in actual service, and be made to exhibit accurately the time occupied by the ball in passing over different parts of the trajectory, the whole problem of measuring the force of gunpowder is solved, to say nothing of the many important results which follow the possession of such knowledge.

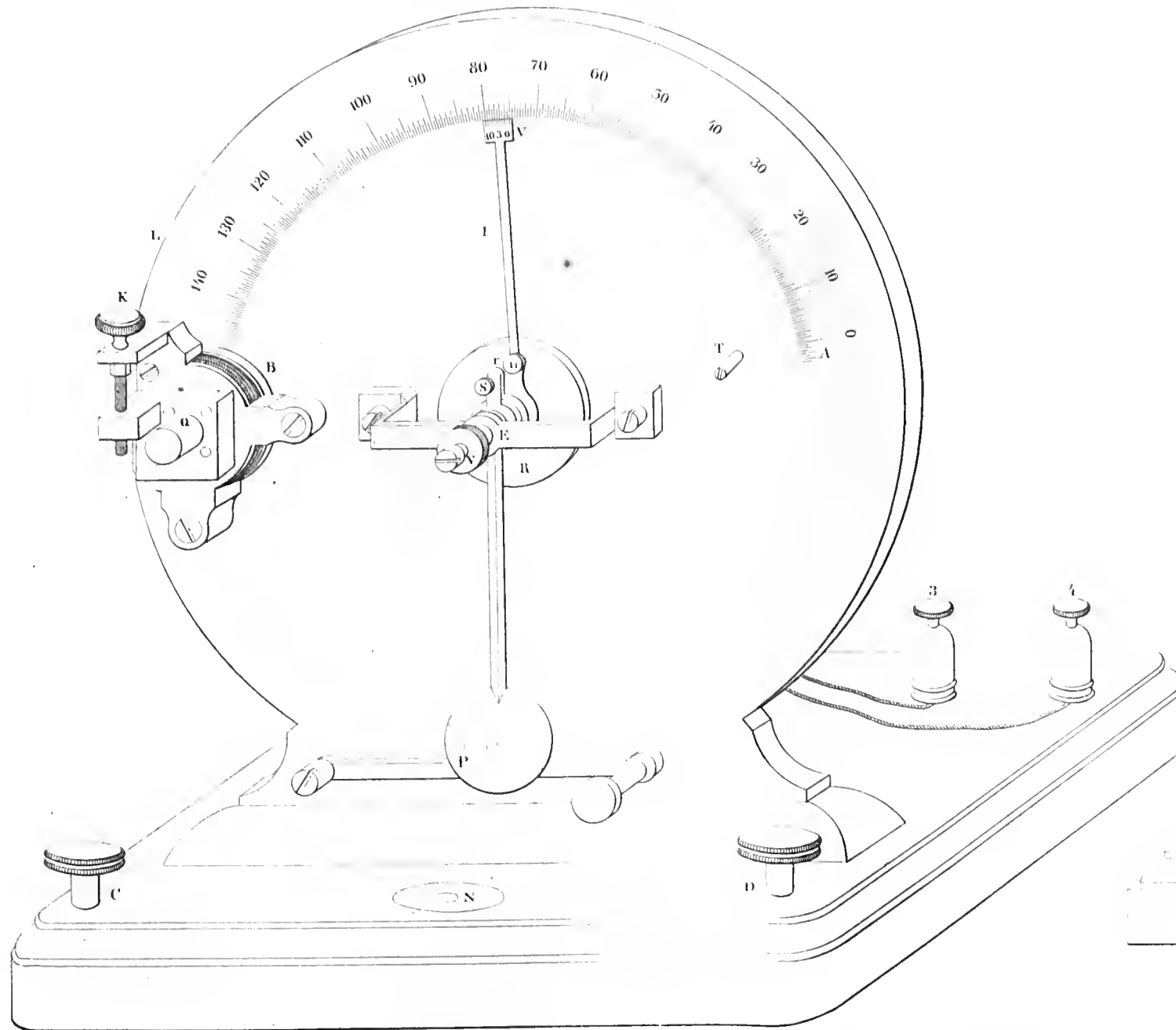
Such an instrument has been invented in the electro-ballistic apparatus of Captain Navez, of the Belgian army; it was invented ten or twelve years ago, and has been adopted into almost every European army. One of these instruments has been obtained for the U. S. Military Academy, and another is in operation at the school for artillery practice at Old Point Comfort.

262. The apparatus consists of three distinct parts, viz.:

1. The pendulum.
2. The conjunctor, or establisher of currents.
3. The disjuncter, or interrupter of currents.

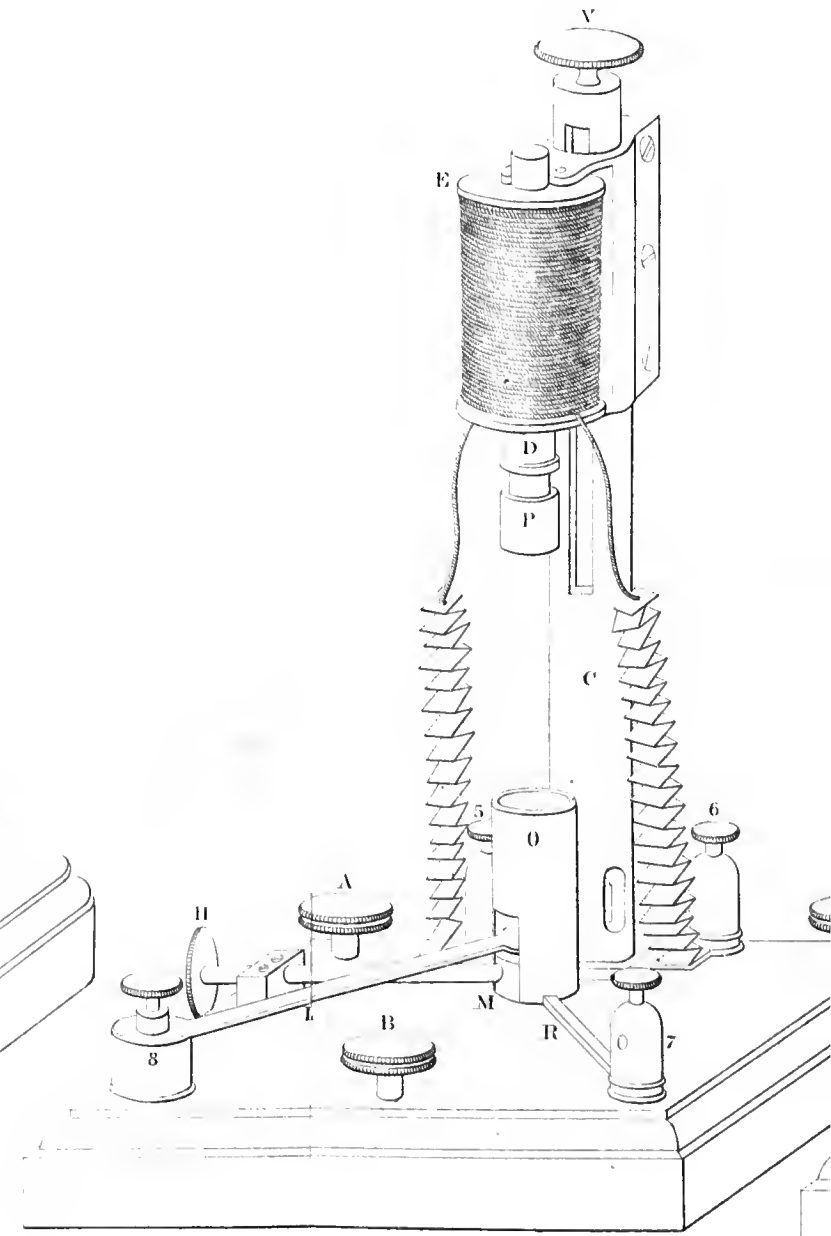
263. **The Pendulum.** The first consists, fig. 57, plate III., of a strong vertical plate of brass, L L, to which is attached a pendulum, P, the disk of which is also of brass, but has inserted in its side, at *p*, a small piece of wrought iron. The rod of the pendulum is of steel, and is inserted into a piece of very hard bronze, which serves as an axis of suspension for the pendulum.

Fig 57

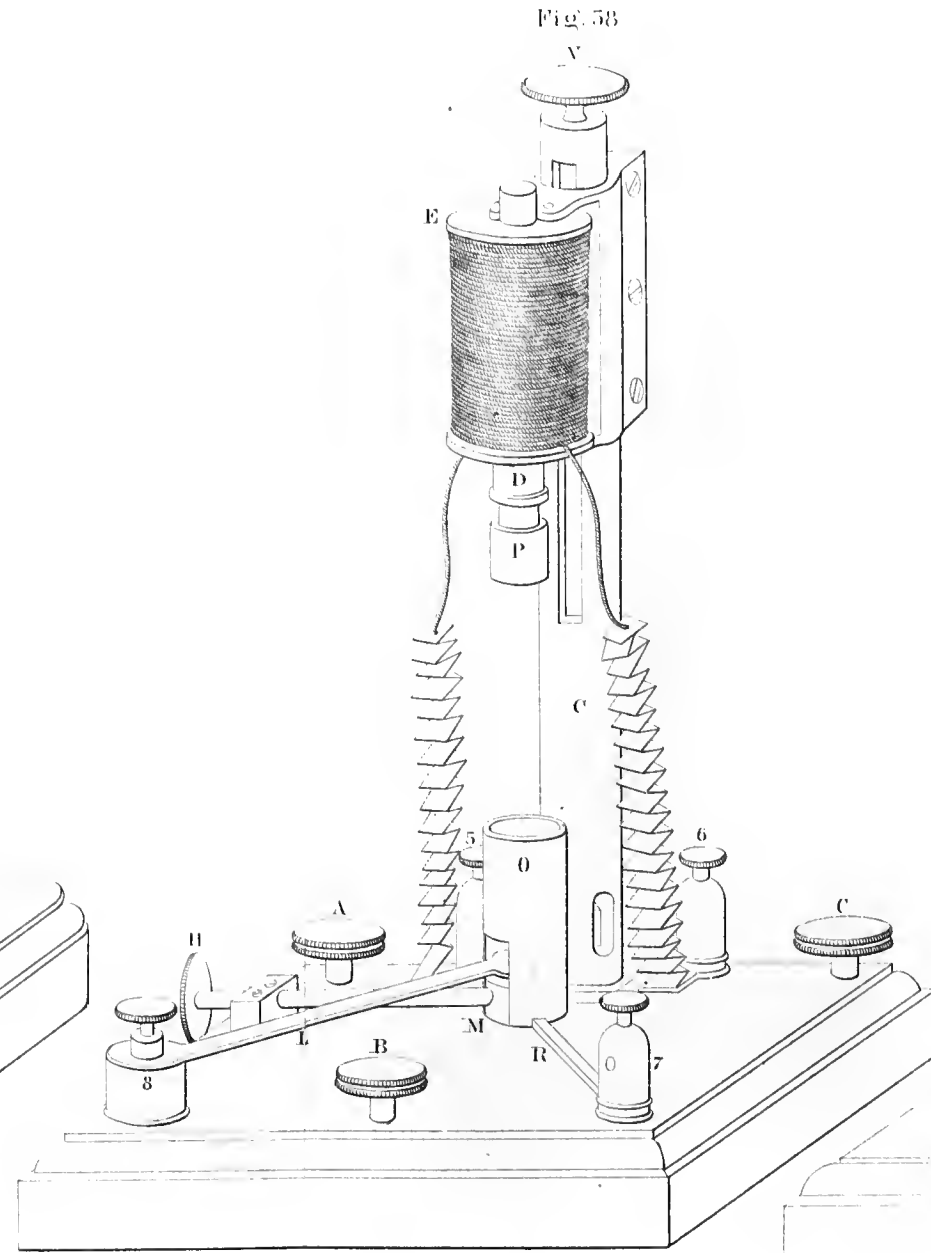
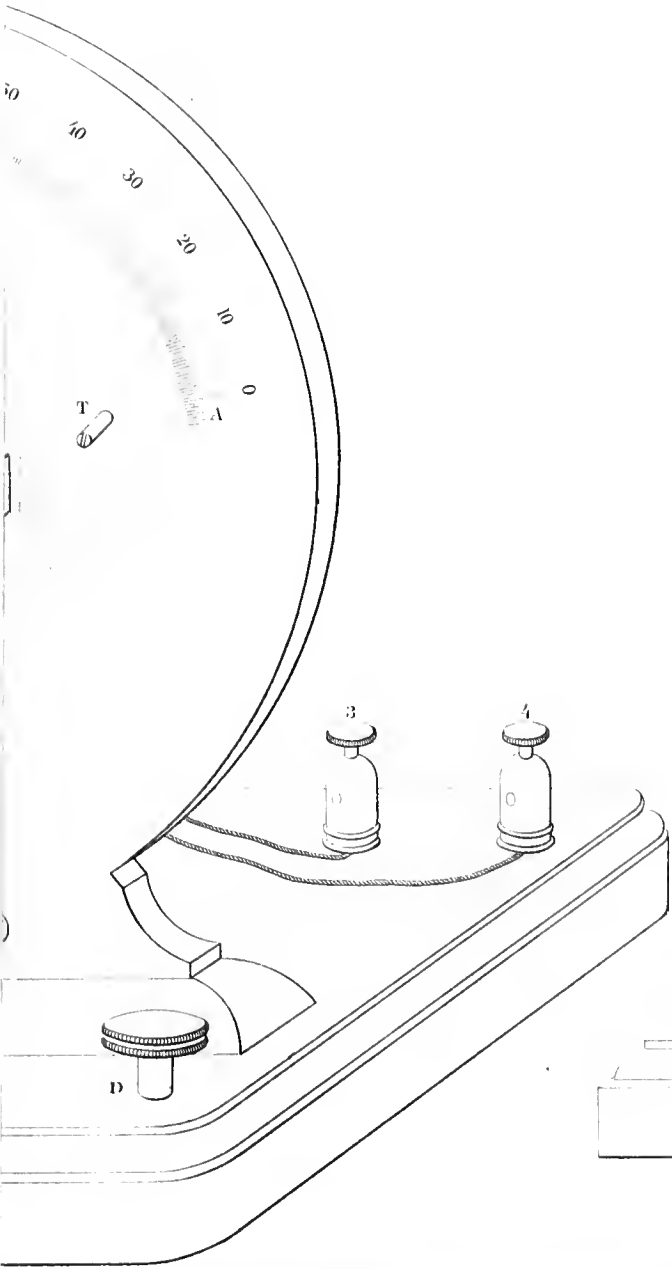


*Pendulum*

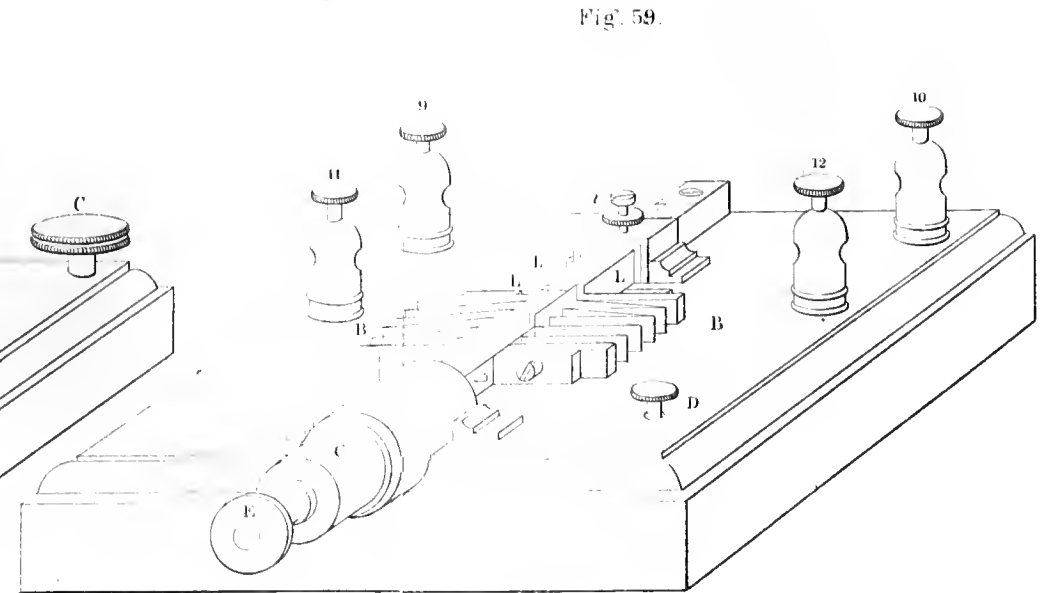
Fig 58.



*Conjuctor.*



*Conjunctor:*



*Disjunctor*

The bronze axle passes through another piece terminated by a circle of iron R, and the two are so nicely fitted that, when the axis moves, R, by friction, is carried around with it. By this arrangement the pendulum, in its movement, carries around with it the iron circle R, together with the pointer I, which is fixed to it. The screw *u*, which passes through the pointer and rests against the plate R, serves to regulate the distance of the vernier V, from the large plate L L. A pin, T, stops the pointer in such a position that the zero of the vernier coincides with the zero of the graduated arc, A B, divided into 150°. The vernier enables us to read the twentieth part of a degree, or three seconds. An opening is made near the edge of the plate L L, through which passes the end of an electro-magnet, shown at Q. This is mounted in such a way that it can be moved up and down by the screw K. At the centre of the plate L L, is placed a circular opening equal in diameter to the small plate R, allowing the entrance of the two extremities of a strong horse-shoe electro-magnet, which is placed behind the plate L L. The two ends of it approach each other sufficiently to allow them to fit accurately into the opening in the plate. The interval between them is filled by a plate of brass, pierced to allow the passage of the axle of the pendulum. This brings the back face of the plate R directly in front of and near the extremities of the magnet.

The instrument is fastened to a solid piece of wood, which is levelled by means of spirit-levels and screws, seen at N, C, D, &c.

264. **The Conjunctor**, fig. 58, plate III. An electro-magnet, E, moves along the column C; its movement

being regulated by the screw V. Two strips of copper, bent in zigzags, serve to establish communication between the magnetic wire and the screws 5 and 6.

Under the electro-magnet is a small iron cup, M, in which some mercury is placed. The screw H passes through the side of the cup, and serves to regulate the height of the mercury. Around the cup, and extending a short distance above it, is placed the brass cylinder, O. A copper ribbon or wire, R, connects the cup of mercury with the screw 7. From the screw 8 a blade of tempered steel, L, projects, the end of which being directly over the cup, has an iron point projecting downward toward the mercury.

A leaden weight, P, surmounted by a piece of wrought iron, is kept in the position shown in the figure by the attraction of the electro-magnet, E, when active. The wooden base to which this apparatus is fixed is levelled by means of three levelling screws, A, B, and C, and a plumb line hung in the inside of the column, and seen through slits cut along the length of the column.

265. **The Disjuncter**, figure 59, plate III. Two blades of copper, L L, separated by a piece of ivory, are connected, the one with screw 9, the other with 10 by copper bands running on the under side of the board on which this instrument is built.

Two other similar blades, L' L', which are also separated by ivory, form a movable system whose extremity may be introduced between the blades L and L, rubbing them slightly as they enter. Each of these movable blades is connected by the zigzag copper ribbons B, B, with a screw on its own side of the platform (11 and 12).

A steel rod jointed to the piece of ivory separating

the movable blades, passes through the cylinder, C, and having a thread cut on the end, screws into the knob, E. In the cylinder C is placed a strong spring, which, acting on the movable blades, keeps them separated from the fixed ones. By pressing on the knob E, the spring yields, and the movable blades are pushed up between and in contact with the others. A catch beneath the platform, and pushed up by a small spring, catches in a notch made in the steel rod, and holds it and the blades in that position until by pressing on the trigger at D, the catch is disengaged and the blades L' L' fly back.

266. These constitute the apparatus of Captain Navez; which, for use, is placed securely under shelter, where it will be completely protected from the weather.

The pendulum and conjunctor are placed on a heavy table, the feet of which rest on solid ground, and no part of which touches the walls of the building, in order that no disturbance may result to the instruments from the firing of the gun.

The disjuncter is placed upon a table not touching the other. The working of the disjuncter causes a jerk which interferes with the operation of the conjunctor if placed on the same table with it. Figures 57, 58, and 59, represent the three instruments in their proper positions.

267. It is very important to place the pendulum in such a position that the oscillating system between its initial point and that of stable equilibrium shall have passed over an angular distance of  $75^\circ$ , corresponding, from the construction of the instrument, to one-half the graduated arc. This is effected in the following manner: the pendulum bed is first levelled by means of the

levelling screws; the disk is then raised until the small piece of iron, *p*, comes in contact with the end of the electro-magnet at *Q*. The pointer, carried around by the movement of the pendulum, will rest against the pin *T*, and the zero of the vernier coincide with the zero of the limb. Let go the pendulum, and allow it to come to a state of rest. If in that position the zero of the vernier coincides with the seventy-fifth degree of the limb, the instrument is properly adjusted; if it does not the electro-magnet is lowered or raised by the screw *K*, and the operation is repeated until the zero does coincide with the seventy-fifth degree. Before raising the pendulum, see that the pointer is situated somewhere between 0 and 75°. The moment the pointer strikes the pin, the axis of suspension will commence to turn in the washer which supports the pointer, and continue to do so until the disk meets the magnet *Q*.

The conjunctor being placed alongside of the pendulum, its column is placed in a vertical position by means of its plumb-line and the levelling screws.

268. Two galvanic batteries are needed to work the apparatus. Bunsen's are generally used, fig. 60, plate IV.; and to avoid corroding the instruments from the gases evolved, the batteries are placed outside of the building which contains the instruments.

269. **Manner of Using Navez's Machine.** Two target frames, *C* and *C'*, plate IV., fig. 61, are placed along the line the shot is to travel, and at such distances as to comprise between them that part of the trajectory the time in describing which it is designed to measure. The size of these frames will depend upon the distances at which they are placed from the piece, and the accuracy

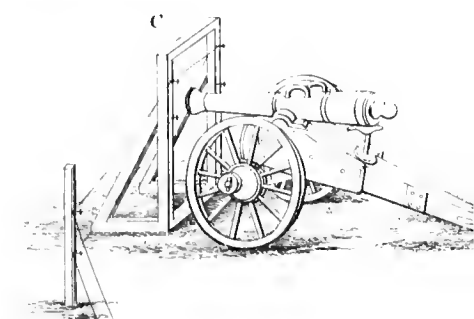
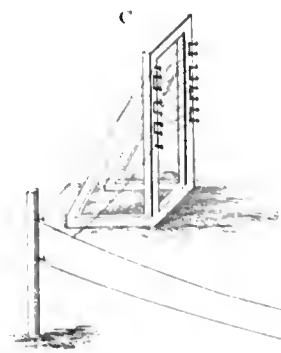


Fig. 61.

Fig. 60.

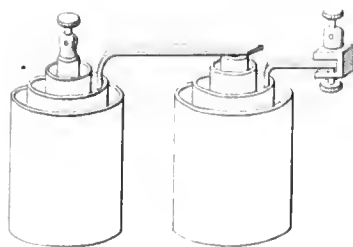
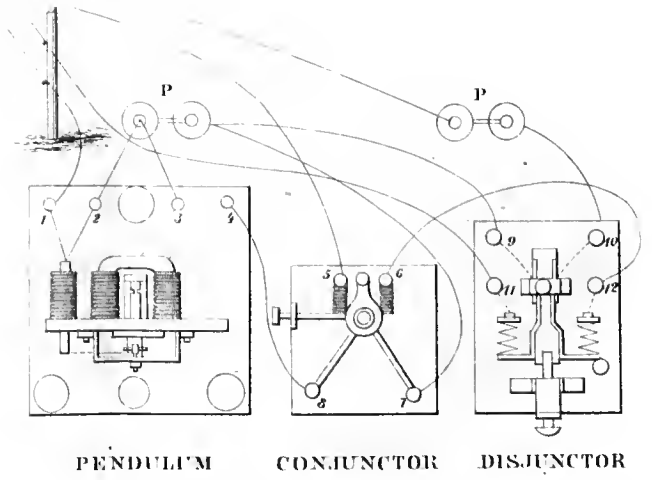
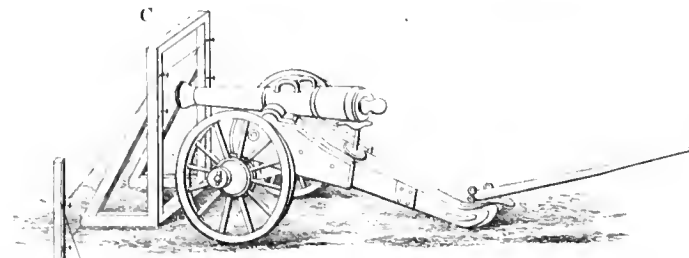


Fig. 61.



of fire. These frames are covered with copper wire in parallel lines, the spaces between being about two-thirds the diameter of the shot to be used. The apparatus, batteries, and targets, are connected by means of wires, which are held in their positions by the press-screws of the different instruments. Posts ten or fifteen yards apart are used to support the wire running to the targets, being provided for this purpose with nails covered with gutta percha.

270. Three currents are established for the working of the apparatus, whose courses will be designated on plate IV., fig. 61.

271. No. 1, leaving the battery, P, reaches the coil of the electro-magnet, Q, through the press-screw, 2, magnetizes that magnet and passes out through the screw 1 to the target C, from whence it returns to the screw 11 of the disjuncter, and passes into the left movable blade; and as this is in contact with one of the fixed blades (the knob E having been pushed up) the current passes on to the screw 9, and returns to the battery from which it proceeded.

272. No. II., leaving the battery, P', proceeds through the conductor to C', returning to the screw 5 of the conjuncter, from whence it passes into the coil of its magnet, magnetizing that, and passing out at the screw 6, it reaches the screw 12 of the disjuncter, passes through the right movable and fixed blades, and the screw 10, to return to its battery P'.

273. No. III., leaving the same battery as No. I. (P), passes through the coil of the large magnet of the pendulum, magnetizing it, and passing out by the screw 4, proceeds to the screw 8 of the conjuncter. The steel

blade carries it to the cup of mercury, from whence it goes to the screw 7, and so back to the battery P.

274. We will now describe the manner in which the instrument works. The gun is loaded, the disjuncter is not in gear, that is, the movable and fixed blades do not touch each other, and in the conjuncter, the point on the steel blade does not touch the mercury. None of the currents are established. The operator, seated before the instrument, with the right hand puts the disjuncter in gear to establish the currents I. and II. With the finger of the left hand, he raises the pendulum until the iron *p* in the disk touches the magnet Q, which, being magnetized, retains it there. The zero of the vernier coincides with the zero of the limb. He then suspends the weight P to the magnet of the conjuncter. This weight, when in position, has its axis coincident with the vertical axis of the magnet, in order that it may fall accurately in the cylinder O.

275. The operator now presses upon the trigger D of the disjuncter, releasing the movable blades, which, flying back, rupture the currents I. and II. *simultaneously*. The pendulum and weight commence falling as soon as their respective magnets become sufficiently unmagnetized. As soon as the weight strikes the end of the steel blade, this bends, putting its point in contact with the mercury, which, establishing current No. III., the large magnet of the pendulum becomes active, acts on the iron plate R, fixing that, and consequently the pointer attached to it. The pendulum, however, continues to oscillate, the axis turning in the muff.

276. Having noted the arc passed over by the pointer, which we will call S, withdraw the weight from

the cylinder O. This releases the steel blade, which, rising, breaks the current No. III., and the large magnet no longer attracts the plate R, which is pulled away from its position against the ends of the magnet by seizing the muff with the thumb and forefinger.

277. The disjuncter is immediately put in gear, the pendulum replaced in its old position, and the weight suspended again to its magnet. The operator now gives the signal to fire, and the projectile as it passes through the targets C and C', cuts the wire, breaking *in succession*, first current I. (when the pendulum begins to fall, moving the pointer along the graduated arc), and then current II. (when the weight P begins to fall), which, causing the iron point to enter the mercury establishes the current No. III. which, magnetizing the large horse-shoe magnet behind the plate R, stops the plate in its movement, thus fixing the pointer, which is found to have passed over a greater arc than when the two currents I. and II. were ruptured simultaneously. The difference between the arcs described by the pointer, when the currents are ruptured *simultaneously* and when they are ruptured *in succession*, will correspond exactly to the time employed by the projectile in passing over the distance between the two targets.

278. This method, then, consists in making the apparatus work two successive times under exactly *the same circumstances*. The first operation, effected by means of the disjuncter, is, in fact, the same as if the projectile cut both wires at the same time, or the space passed over was nothing; whilst, in the second, effected by means of firing, the space passed over by the projectile is that comprised between the two targets.

279. The principal advantages of the apparatus over all others yet invented, consists in its accuracy, the ease with which it is worked, and its cheapness as compared with the unwieldy and expensive machines used at present, in this country, for the testing of gunpowder. But its principal advantage is its applicability to every kind of piece by which the force of gunpowder, as it is actually used in every gun in service, can be determined.

280. **Storage of Gunpowder.** In the storage of gunpowder especial pains should be taken to secure it against the effects of moisture and the dangers of explosion. Powder magazines are generally built of brick or stone, in a very substantial manner, and in places free from moisture and remote from danger. Except in time of war, they are generally placed beyond the exterior works of fortified towns, and surrounded by a wall and ditch. They should be so constructed that the air may circulate freely through them, and the powder casks should be so arranged as to rest neither upon the ground nor against the wall. The condensation of watery vapor which takes place in hot weather upon the thick walls of brick or stone in magazines produces a degree of moisture which may be avoided, when the circumstances will admit, by building the magazines of wood.

281. In ships of war, the magazines are placed as low as possible, and carefully lined with lead. They are never entered except for the purpose of obtaining powder or of turning the barrels; and the sea air is always excluded as much as possible. The powder should be turned twice a year, and proved once in every five years.

282. **Damaged Gunpowder.** By the action of moisture the materials are separated; the nitre is brought out and crystallized upon the exterior, so as to prevent the inflammation of the grains, and unite them in lumps.

When gunpowder has been slightly damaged by moisture, it may be restored to a good condition by drying it on cloths in the sun, taking care to stir it frequently that the drying may be uniform. It is then proved anew.

When, however, small crystals of nitre are seen on the grains, and when lumps are formed, the powder can only be restored by remaking it. In this case, there is always a loss of nitre; the quantity of nitre required for the restoration of the powder is mixed with it, and the whole subjected to the same process as in the first manufacture.

When sulphur or charcoal has been lost in sufficient quantity to be observed, the powder is not reworked.

283. **Gun-Cotton.** In 1846 the announcement was made of the discovery of a substitute for gunpowder. This announcement was made by Prof. Schönbein of Bâle, Switzerland.

To prepare it, well-cleaned, ordinary cotton is steeped for about half a minute in highly concentrated nitric acid. It is then washed several times in pure water and dried, when it is ready for use.

When thus prepared, it explodes like ordinary powder, when struck a sharp blow, or when brought in contact with a coal of fire.

In the first experiments made, its projectile force was found to be so great as to favor the idea that for military purposes it was far superior to gunpowder; it being

found that, in moderate charges, its force was equal to that of about twice its weight of the best powder. But by further experiments it was found that its explosive or bursting force is much greater than that of ordinary gunpowder, resembling more the action of fulminates. It is, therefore, in its effects on guns much more injurious than powder; though for mining purposes it is well adapted, especially in sieges, as, burning without smoke, the workmen in the galleries would be less incommoded. From the rapidity of its action, it is suitable for loading shells, which are burst into a much greater number of pieces than when loaded with five times the amount of ordinary powder.

When compressed by hard ramming, as in filling fuzes, it burns slowly.

It is more liable than powder to absorb moisture, by which its force is rapidly diminished; but by drying it is immediately restored, with but slight diminution of strength, possessing thus one great advantage over ordinary powder, which is difficult to restore.

**284. Proportioning Charges of Powder.** The proper charge of powder for a gun is proportioned by the initial velocity of recoil which the charge will produce. The gun which recoils with least violence upon its breeching, when fired with full service charge of one-third, is the heavy long gun of two hundred pounds of metal to one of shot. The shot from this gun, with this charge, has an initial velocity of sixteen hundred feet per second; and the initial velocity of recoil of the gun is to the initial velocity of the shot inversely as their respective weights, and hence is eight feet per second. Eight feet per second may, therefore, be taken as an in-

itial velocity of recoil which it is well not greatly to exceed.

To determine the charge for proportionally lighter guns, it is necessary first to ascertain the velocity that can be given to a shot without producing a recoil of more than eight feet per second. This is called the *fixed velocity* of the shot, and is found thus :

Multiply the weight of the gun by eight, the safe velocity of recoil ; the product is the momentum of the gun, and hence also of the shot ; divide this momentum by the weight of the shot, and the quotient is the required fixed velocity of the shot.

The next step is, to determine the charge of powder which will produce this velocity, by the following rule :

As the square of sixteen hundred is to the square of the fixed velocity, so is one-third the weight of the ball to the required weight of the powder ; or in other words : multiply the square of the fixed velocity by one-third the weight of the ball, and divide the product by the square of sixteen hundred ; the quotient is the required weight of powder.

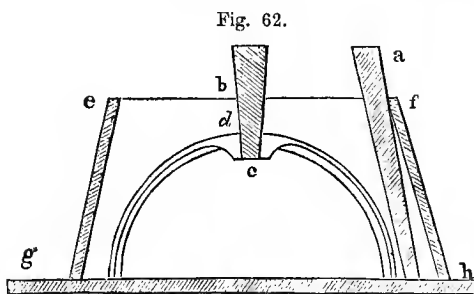
In proportioning the charges of powder for the navy shell guns, they will be found somewhat to exceed the amount of powder that would be given by this rule.

## CHAPTER VI.

## PROJECTILES.

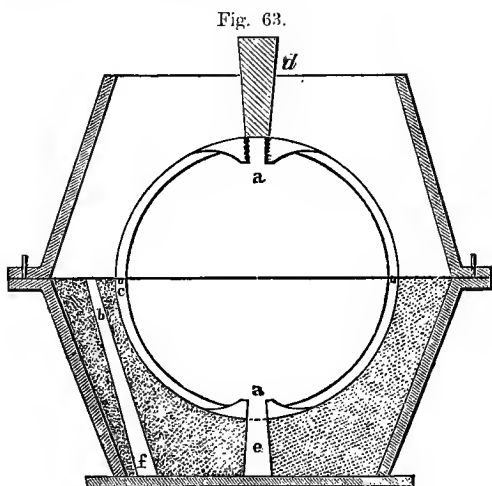
285. **Moulds.** In the manufacture of projectiles, iron moulds have sometimes been used, but are found to make an inferior, brittle article, liable to be easily broken, principally from the more rapid cooling of the metal. The moulds are now made of sand, similar to that used in casting guns, though a less refractory sand is needed, as the mass of metal is less, and possesses, consequently, a less amount of heat. It is, as before, mixed with clay-water, to give it form and consistency.

286. **Models.** The model consists of two polished hemispheres of copper, which, fitted together by means of a groove in one and projecting edge in the other, form a perfect sphere. One of these hemispheres is placed on a board or other plane surface. Over this is placed one half of the *flask*, a sheet-iron box in two parts, fig. 62, made to fit each other, for the purpose



of containing the mould. Each half has a movable bottom, taken off while the sand is being placed in. Each one of the copper hemi-

spheres has in the bottom a hole and thread of a screw, *c*, into which a handle can be placed to lift the model out of the mould, and on the outside at *d*, a corresponding hole and thread into which the handle *b* is not screwed. A round stick, *a*, is held in a suitable position against the board on which the flask rests, and the moulding is driven compactly in until the flask is full to the line *e f*, when it is accurately levelled off, the handle *b* unscrewed, and with the stick *a* removed. The bottom is placed on, secured in its place, and the whole turned over; the board, *g h*, taken off and the other half-model and flask adjusted on top of the first ones, dry sand being sprinkled on top of the half-mould *a* formed, to prevent the other from sticking to it: fig. 63.



After screwing the handle of the other half-model in its place, this flask is filled, the handle removed, and bottom put on in the same way as at first.

The top half is then taken off and turned over, and both half-models are taken out by screwing in the handle at *a*, and lifting them up carefully so as not to break the mould; a passage is cut at *c*, across the channel *b*, and if casting solid shot, the hole left by the handle at *d* is closed with sand. Any parts which have been broken away are

now repaired by hand, and the whole interior is covered with coke-wash; the mould is placed in an oven to be thoroughly dried, after which the two parts are fastened together, with the two apertures *b* and *e* uppermost.

287. **Casting.** The metal, in a proper state of fluidity is brought from the furnace in a ladle, fig. 64, of iron,

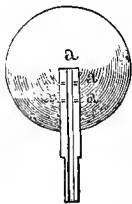
Fig. 64.



coated with clay, having wrought-iron or wooden handles, and poured into the mould at *f*, entering at the side to prevent injury to the form. As it rises, the air escapes at *e*, which also serves as a sinking-head to collect the scoria, if any enters, and furnishes metal to supply the shrinkage caused by cooling.

288. **Casting Shells.** In casting shells, the mould is made in the same way, but a *core* is needed in addition. This is a sphere of the proper size, made by compressing the moulding composition on a *stem*, fig. 65, by means

Fig. 65.



of two cups, the requisite compression being given by screws. This core is, by means of a gauge, placed exactly in the centre of the mould, and supported in that position by the stem placed in the hole, which, in casting solid shot, was closed. The core being subjected to greater heat than the other portion of the mould, should be made of a more refractory sand. The stem, besides supporting the core, forms the fuze-hole of the shell. It is formed of a thick wire covered with the moulding composition. The stem is sometimes made hollow, as at *a, a, a*, fig. 65, to allow the escape of any gases which may form from the effect

of the heated metal. After the casting has become cool, the core is broken up and removed; and the projecting portions at the gate *c*, fig. 63, and around the base where the two halves join, are taken off with a hammer and chisel.

289. **Polishing.** A number of the balls are now placed in a large revolving iron cylinder, which, by friction, polishes and makes the surface more uniform; after which, and before any lacker or grease is placed on them, they are inspected.

Projectiles for cannon are universally made of iron.

290. **Navy Shot and Shells.** Shot and shells provided for the U. S. Navy are made of gray or mottled iron, soft, and of good quality. They must be cast in sand moulds, and be smooth on the surface, spherical in form, and free from the defects named in the following process of inspection.

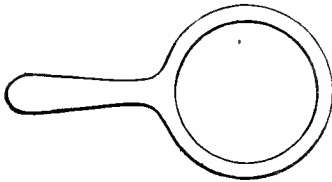
291. **Weighing.** To ascertain if they are of the proper weight, several parcels, of from twenty to fifty, are weighed, being taken from the pile indiscriminately. If any are found smaller than the rest, they are weighed separately, and rejected if they fall short of the proper weight by a small fraction, which has been successively reduced as the improvements in the art of casting enabled a higher standard to be reached. They generally exceed the required weight.

292. **Rule for Determining Weight, &c., of Shot and Shells.** To find the weight of a cast-iron shot of any diameter, multiply the cube of its diameter in inches by 0.134. The result will be the weight in pounds. If the weight of a shell be required, use in this rule the difference between the exterior and interior diameters in place of the

diameter. To find the diameter of a cast-iron shot of a given weight, reverse the rule: divide the weight by 0.134, and the cube root of the quotient will be the diameter in inches.

293. **Inspection of Shot.** The shot is inspected while perfectly clean, and before becoming rusty, so that the eye can detect any flaws or imperfections in the metal. If any attempts have been made to fill these with iron, cement &c., the shot is at once rejected without further examination. Such holes as are found are probed with a *searcher* of steel wire, or struck with the pointed end of the inspecting *hammer*. This hammer weighs about half a pound, and is flat at one end for sounding shot and shell, and conical at the other. Cavities over .2 inch deep cause rejection.

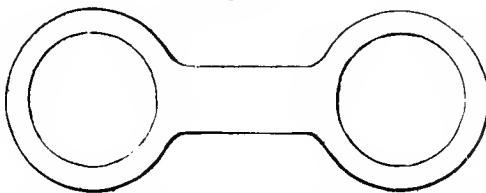
Fig. 66.



294. **Ring-Gauge.** The ring-gauge, fig. 66, is a ring of iron with a wooden handle, used to determine the diameter of the shot. Two sizes are used. The larger is 0.02,

or 0.03 inches greater than the *true* diameter of the shot, and the smaller, 0.02, or 0.03 inches less than the true diameter. The shot must pass *in any direction* through the large gauge, and *not at all* through the small one.

Fig. 67.



The size of grape and canister shot is determined by using a large and small gauge, attached at the op-

posite ends of the same handle, fig. 67.

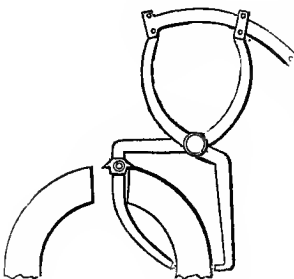
295. **Cylinder Gauge.** The cylinder gauge is a cast-iron cylinder with reinforce bands on the exterior, and an interior diameter equal to the diameter of the large ring-gauge. This is placed on blocks of wood, with one end about two inches higher than the other, in such a position as to be easily turned, so that it will not be worn in furrows by the shot rolling through it. The shot is then *rolled* through; they must pass through without *sticking* or *sliding*. In this last case, it shows that some one diameter is too large. In case they stick, they are pushed out from the lower end with a rammer.

The ring and cylinder gauges shall be examined before each inspection, and when found to have enlarged .01 of an inch, must be laid aside as unserviceable.

296. **Test of Strength.** To test the strength or soundness of shot, they are dropped from a height of twenty feet on a solid platform of iron, or rolled down an inclined plane of the same height against a mass of iron; after which they are again examined for defects of metal.

297. **Inspection of Shells.** Shells are inspected in the same way as shot, except the test of strength by dropping, but require in addition the following instruments, viz. :

Fig. 68.



298. **Callipers, fig. 68,** for measuring the thickness of the shell at points on the great circle, at right angles with the axis of the fuze-hole, which consists of two bent arms movable on a common pivot, and showing on a graduated arc the thickness of the metal; or,

Fig. 69,

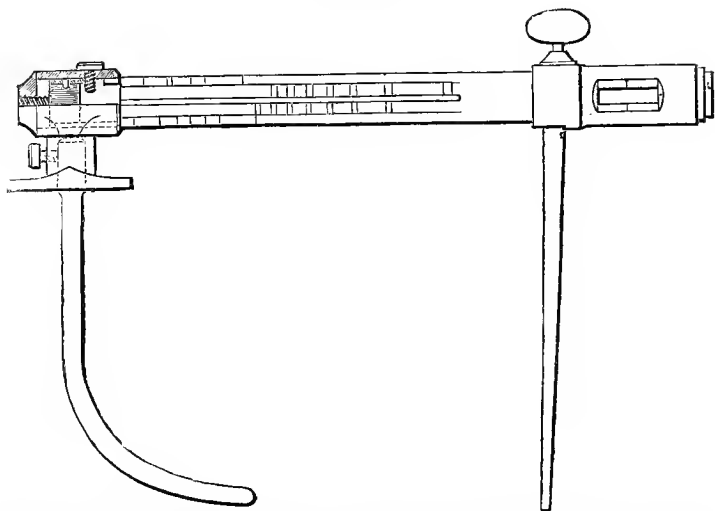
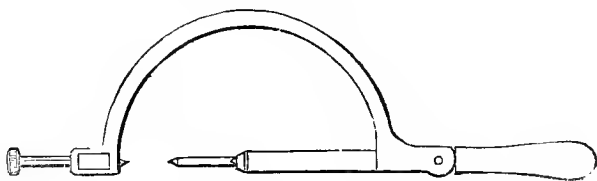


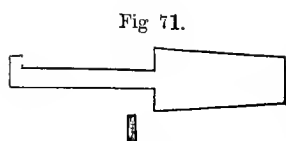
fig. 69, of one straight arm which is placed tangent to the outside of the shell, and one bent, which is inserted in the shell, the thickness being shown on a graduated limb which joins the two.

Fig. 70.



299. Callipers, fig. 70, for measuring the thickness of the shell opposite the fuze-hole, which consists of two straight arms connected by a circular piece. One of these arms is inserted in the shell, and the other, being movable, shows on a graduated side the thickness of the metal.

300. Gauges, fig. 71, for the dimensions of the fuze-hole, and thickness of metal at that point. These are



pieces of plate metal having inclined sides to fit the fuze-hole, with the proper dimensions marked on them for each calibre.

301. A pair of hand-bellows, and a wooden plug to fit the fuze-hole, and bored through to receive the nose of the bellows.

302. The shell is sounded with the hammer, to see if it is free from cracks. The thickness of metal is measured at several points on the great circle perpendicular to the axis of the fuze-hole, at the bottom, and at the fuze-hole. The diameter of the fuze-hole, which should be accurately reamed out, is measured with the gauge, and the soundness of the metal about the inside of the hole is ascertained by inserting the finger.

The shell is then placed in a tub of water, which should be deep enough to cover the shell nearly to the fuze-hole. Air is then forced by the bellows into the shell. If there are any holes in it, air bubbles will rise on the surface of the water, and the shell shall be rejected. This occasionally occurs from the escape of air from porous spots which do not extend to the interior of the shell. In this case the action of the bellows produces no increase of bubbles, which cease rising as soon as the spots or cavities are filled with water. Porous spots are also detected by their absorbing water, and drying slowly when exposed to the air, and shall likewise cause the rejection of the shell. Rejected shells are to be mutilated by chipping out a piece at the fuze-hole. Rejected shot are to be marked with an X near the *gate*, or point where the metal entered the mould.

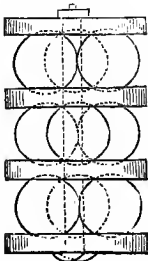
303. **Calibres.** The calibre of solid shot or balls is

expressed by the round numbers of pounds contained in them. At present there are but two solid shot used in our naval service, viz., the 64 and the 32. The different varieties of shot may be classed as follows: Round shot, bar shot, chain shot, grape shot, and canister shot. Bar shot and chain shot are not now in use.

304. **Bar Shot.** Bar shot consists of two solid hemispheres connected by a bar.

305. **Chain Shot.** Chain shot consists of two hollow hemispheres, which when their bases are brought together, enclose a piece of chain which is attached to both hemispheres. When the shot is projected, the two parts separate to the distance limited by the length of the chain, and sweep over considerable space; a chain shot has been known to cut a foresail from its yard; they are particularly serviceable in dismantling an enemy at short distances. Of course they are very inaccurate in their flight.

Fig. 72.



306. **Grape Shot.** A stand of grape consists of nine shot, fig. 72, of a size appropriate to the calibre used, which are held together by two rings, and a plate at each end of the stand connected by a rod or bolt.

Quilted grape consists of an iron plate and an upright spindle, around which balls are placed and held in their positions by a canvas bag, which is tied to the plate, and quilted on to the balls by means of strong twine, which is finally tied around the mouth of the bag.

307. **Canister Shot.** Canister shot is a tin cylinder with iron heads, filled with balls packed in with saw-

dust. The heads are movable, and the edges of the tin are turned down over them to hold them in their places. The balls are made of such a size that seven of them can lie in a bed, one in the middle, and six around, making the diameter of the balls about one-third that of the bore. These balls are made of cast-iron.

308. **Hollow Shot.** Hollow shot are divided into *shells, spherical case or shrapnel, and carcasses*; all of which are made of cast iron. Their calibre is determined either by the number of pounds contained in a solid shot of the same size, or by the number of inches in the diameter of the shell itself.

309. **Shells.** Shells are hollow shot, the interior space being formed of a sphere concentric with the outer surface, thus making the sides of equal thickness throughout. They have a conical opening, used to load the shell, and in which is inserted the fuze to communicate fire to the bursting charge. Formerly the shell was not filled through the fuze-hole, but another hole was made, called the filling hole, through which the bursting charge was poured into the shell. The resistance offered by a shell to the force of the powder increases with the thickness of its sides. The number of pieces produced when it explodes is the greater, all else being equal, as the metal is more brittle.

310. **Spherical Case.** Spherical case or shrapnel, as they are called, after the English general who has the credit of having introduced them, are thin-sided shells, in which, besides the bursting charge, are placed a number of musket balls. Their sides are much thinner than those of the ordinary shell, in order that they may contain a greater number of bullets; and these acting as a

support to the sides of the shell prevent it from being broken by the force of the discharge. The weight of the empty case is about one-half that of solid shot of the same diameter.

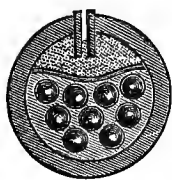
Lead being much more dense than iron, the shrapnel is, when loaded, nearly as heavy as the solid shot of the same calibre. When the shrapnel bursts just in front of an object, the effect is terrific, being in fact pretty much the same as a discharge of grape from a piece at short range. The moment when the shrapnel will do most service is at that distance when grape ceases to be effective. The balls, liberated from the case, have no velocity except that due to the remaining velocity of the case, the charge contained in the case being only sufficient to rupture it, and liberate the balls; in this consists its distinctive difference from the shell, the power of which lies much in the strength of the bursting charge that it may be able to contain.

311. **Charging Shrapnel.** Shrapnel, when first used, were loaded by simply dropping through the fuze-hole a number of balls, and afterward pouring in a bursting charge of powder which disseminated itself in the interstices left by the balls; the present method by confining the powder to a chamber, prevents the powder from being crushed by friction, and enables the bursting charge to be reduced. The present method of loading consists in dropping in the proper number of balls, and then pushing through them, until it rests on the bottom opposite the fuze-hole, a mandril grooved on both sides (first screwing a cup into the fuze-hole). Into this cup melted sulphur is poured, which enters the case through the grooves along the sides of the mandril, and when

the sulphur is cool, the mandril is withdrawn, leaving in the centre of the mass a small chamber in which the bursting charge is placed. Sometimes the mandril is not used, but the melted sulphur is poured in through the fuze-hole until the case is full, and when the sulphur has cooled, the space for the powder is bored out by a cutter, which removes both the sulphur and portions of the bullets from the space. This arrangement places the powder entirely free from contact with the bullets, and it is consequently not liable to be ground up by them while being transported or when the shell is fired. The powder can be placed in this chamber and allowed to remain without fear of damage or danger, and be all ready for use when required. Being, besides, in a compact mass, instead of scattered among the bullets, its power is much greater, admitting, as before stated, of a reduction of the bursting charge.

312. **English Shrapnel.** Figure 73 represents the

Fig. 73.



shrapnel in use in the English service, where a portion of the shell is partitioned off by a diaphragm of sheet-iron, establishing two chambers, one for holding the balls, the other for containing the bursting charge. The spaces between the balls are packed with coal dust. The object of the diaphragm shell is to guard against any chance of explosion of the bursting charge by concussion. In order that the balls may be released in a uniform manner, four grooves are cast in the interior of the shell, to determine the fracture.

313. **Carcasses.** Carcasses are shells having three additional holes, which are placed at equal distances

apart and tangent to the great circle of the shell which is perpendicular to the axis of the fuze-hole. They are filled with a composition consisting of a solution of equal parts of white turpentine and spirits of turpentine, incorporated with as much port-fire composition as will give the whole a compressible consistency; the port-fire composition must be previously mixed with a small quantity of finely chopped tow. When properly incorporated, this composition is compactly pressed into the carcass with a drift, so as to fill it entirely. Sticks of wood of about half an inch in diameter are then inserted into each hole of the carcass, in such a manner as to meet in the centre of the composition, in order that, when they are withdrawn, as many holes shall remain in the composition, in the same direction. In every hole thus formed, three strands of quick-match are inserted, of a length sufficient to allow of their being folded over the edge of the hole two or three inches; some dry port-fire composition is pressed into the interstices to keep the quick-match fast in its place. The quick-match must be coiled into the holes and secured, until the carcass is wanted, by fastening a small patch over the holes. Carcasses may be filled with the above composition omitting the tow, and the holes may be bored with a gunner's gimlet before the composition becomes hard.

Common shells may be loaded and used as carcasses in the following manner: the bursting charge is first placed in the bottom of the shell in a flannel bag, over which carcass composition is driven until the shell is nearly filled; then insert four or five strands of quick-match, which must be secured by driving more compo

sition upon it. These shells after burning as carcasses, explode.

314. **Sabots.** In order to preserve the shell in its proper position in a gun, a block of poplar, linden or other light close-grained wood is secured to the hemisphere opposite the fuze-hole; these *sabots* are strapped to the shells by straps of sheet-tin. Sheet-tin is made by coating sheet-iron with tin. The iron is first scoured, or thoroughly cleaned by means of an acid, and then immersed in melted tin.

315. **Hot Shot.** Hot shot are sometimes used as projectiles, particularly against ships when engaged with forts. Care is required in loading. The muzzle being sufficiently elevated to allow the ball to roll down the bore, the cartridge is inserted; a dry hay wad is placed upon it, then a clay or wet hay wad, and rammed down; and, if firing at angles of depression, a wad of clay or a wet hay wad is put over the ball.

The charges for hot shot are from one-quarter to one-sixth the weight of the ball. With low velocities, the shot splits and splinters the wood, so as to render it favorable for burning. With great velocity, the ball sinks deep into the wood, is deprived of air by the closing of the hole, and chars instead of burning the surrounding wood. The shot should not penetrate more than ten or twelve inches. The wood is not ignited until some time after the penetration of the ball.

The wads are made of hay or clay. Clay wads should consist of pure clay, or fuller's earth, free from sand or gravel, well kneaded with just enough moisture to work well. They are cylindrical, and one calibre in length.

Hay wads should remain in soak at least ten or fif-

teen minutes. Before being used, the water is pressed out of them.

When hay wads are used, vapor may be seen escaping from the vent on the insertion of the ball; but as this is only the effect of the heat of the ball on the water contained in the wad, no danger need be apprehended from it. With proper precautions in loading, the ball may be permitted to cool in the gun without igniting the charge. The piece, however, should be fired with as little delay as possible, as the vapor would diminish the strength of the powder.

316. **Martin's Shell.** Experiments have been made in England upon a new projectile, which is an ingenious substitute for redhot shot. It is styled *Martin's Shell*. It consists of an ordinary shell furnished with an iron screw stopper. Iron is melted in a furnace, and the shell filled with the molten iron before firing. To be effective it is necessary that the firing take place as soon as possible after the shell is charged, for the rapid cooling of the melted metal will so destroy its liquidity as to prevent the maximum effect from being exerted; for, on impact, the shell is intended to break, scattering the liquid metal in every direction, setting fire to any thing in the vicinity at all inflammable. Should it fail to break and scatter its contents, it must still be very formidable as a hot shot.

317. **Norton's Liquid Fire.** There is a composition, also, in England, known as "*Norton's Liquid Fire*." In the character of its effects, it rivals all that has been recorded of the old "Greek fire." The composition that Captain Norton uses consists of a chemical combination of sulphur, carbon, and phosphorus. He merely encloses

his composition in a metal, or even in a wooden shell, and its effects upon striking the sides or sails of a ship, a wooden building, or indeed any object at all combustible, is to cause its instant ignition. Captain Norton says, "Some months after Mr. Allison, civil engineer and chemist, had explained to me the component parts of his liquid fire, viz., phosphorus dissolved in bisulphuret of carbon, I contrived the following simple and safe means of demonstrating its working. I pierced a cork, somewhat larger than that of a wine bottle, longitudinally through its centre, and large enough for the head of a stout arrow to enter; in the other end I inserted a small glass vial filled with the liquid, and closely stopped with a wooden stopper broader on its outside end. The cork, thus prepared, I fixed on the head of an arrow, and shot it against a piece of loose canvas hung on a cord. On striking the canvas, the stopper was forced into the vial, and broke it in pieces, the liquid soaked into the canvass, and in a few minutes set it in a blaze."

318. **Form of Projectiles.** The projectiles fired from smooth-bored cannon are generally of a spherical form, this being the only one which admits the great velocities which are impressed upon them; if the sphere takes up a motion of rotation, the symmetry of its figure renders the effect of that resistance less irregular; and finally the centres of gravity and of figure are less removed than in any other figure, consequently the causes of irregularity are less numerous. If, on the contrary, they have an elongated figure, they take up a very irregular motion of rotation, experience an increased resistance on the part of the atmosphere, and have but little accuracy of flight.

319. **Resistance of the Atmosphere.** The resistance of the atmosphere, during the flight of the projectile, greatly diminishes its effect, and it is the influence of its figure upon this resistance which we should consider. If the elasticity of the air were perfect, and if its particles were independent of each other, the moving surface would impress upon these molecules a velocity equal to that which itself possessed, and the resistance would be proportional to the square of the velocity; but this supposition is not true, for experiment demonstrates that the resistance of the atmosphere increases in a higher ratio than the square of the velocity.

Though not perfectly so, still the air is highly elastic, and when a projectile moves in it, the anterior strata, to a certain distance, are condensed, their pressure increased, and a certain velocity communicated to them; these strata at first escape laterally, then rush in to fill the void in the rear of the body with an accelerated velocity, encountering the posterior hemisphere of the projectile with a less velocity, and exerting upon it a pressure proportionally less than that upon the anterior hemisphere, as the velocity of the body is greater; if the velocity of the body be sufficiently great, this displaced air will not return to its former position until after the passage of the body, and a vacuum will be left in its rear: in any case, the resistance to its motion is influenced by the form of the posterior part of the projectile. These phenomena are similar to those when we move a body in the water, the waves and eddies being similar; we see, then, that a rounded and elongated figure for both the anterior and posterior portions of the projectile would diminish the resistance.

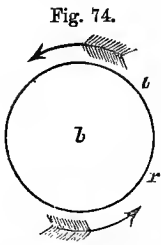
320. **Windage.** The windage of a shot is the difference between its diameter and the diameter of the bore of its gun. Formerly the prescribed windage was the proportional windage of one-twentieth the diameter of the bore; now and since 1840, shot for the U. S. Navy have a fixed windage of from one-tenth to two-tenths of an inch for all calibres. Shot of large windage, owing to their greater disposition to deflect, and the greater force with which they are deflected, produce the most serious lodgements in the gun.

Shot are cast with less diameter than the bores they are intended for, in order, 1st, to allow for want of sphericity; 2d, to allow for the formation of rust on the shot and in the bore; 3d, to allow for the fouling of the bore in long continued firing; and 4th, for the thickness of the straps which bind a shell to the sabot.

If the windage ring be large, much of the force of the inflamed powder will escape past the ball, and be of no service; to avoid this escape is one of the advantages of reduced windage.

321. **Inaccuracies caused by Windage.** Besides the escape and loss of fluid through the windage ring a greater disadvantage arising from large windage is that it occasions inaccuracy in the flight of the shot, for instead of moving along the bore in a line parallel with its axis, and leaving the gun in the same line produced, the shot, if it have great windage, will deflect from the bottom to the top of the bore, or from side to side, and may leave the muzzle with a direction upward or downward, or lateral, which is altogether uncertain, depending upon the point of the muzzle on which the shot last impinged, and therefore necessarily interferes with the accuracy;

for suppose figure 74 a ball projected from a cannon, and having a motion of rotation around a vertical axis,  $b$ , from right to left, due to having impinged on the left side of the bore on leaving the muzzle. The deflection of the ball from left side of the muzzle will cause the ball to deviate toward the right, but the motion of rotation around a vertical



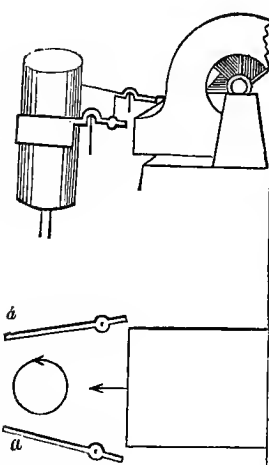
axis having been established, the ball will before the end of its flight deviate toward the left; for the right side of the ball having its motion of rotation in conjunction with its motion of translation, exceeds in velocity the left side of the ball, which has its motion of rotation in opposition to its motion of translation; the right side thus experiences greater resistance than the left side, the ball will incline to the direction of least resistance, hence a deviation to the left.

322. **Direction of Deviations not Constant.** The direction of this deviation will remain constant as long as the axis of rotation remains parallel to itself; but if, from the disturbing influence of the air combined with other causes in the ball itself, the axis of rotation changes its direction, the direction of the deviation will also change, and this explains why a ball may deviate on both sides of the plane of fire during the same flight.

323. The effect produced by this cause is analogous to that which makes a ship *ardent*, when, from carrying sail hard, her lee bow being much buried in the water, she has a tendency to fly up into the wind. The compressed air in front of the projectile may be considered as an inclined surface, up which the shot is constrained to mount by reason of the reaction from the surface itself.

324. As a general rule, the ball in *balloting* along the bore, strikes against the upper part of the bore about half way of the length of the piece, and impinges for the last time on the lower part of the bore at the muzzle; the general deflection, then, is upward, tending to increase the range. But the fact of the last contact being on the lower part of the bore, causes the ball to commence its flight with a rotation around a horizontal axis turning its front side from above downward; the effect of this rotation will be to diminish the range. Thus we see how, as a general rule, one motion tends to compensate the other, each acting as a corrective to the deviation of the other.

Fig. 75.



325. **Magnus' Experiment.** A very ingenious instrument to show the unequal pressure on different sides of a rotating body, has been invented by Professor Magnus, of Berlin. A small cylinder, fig. 75, with a vertical axis, is placed in front of a fan-wheel, by turning which a current of air is forced against the cylinder. Two light vanes, *a a'*, are balanced on points on each side of the cylinder by weights on the opposite sides of the pivots. So long as the cylinder remains stationary, these little vanes are inclined at the same angle toward it, but the moment a rotary motion is given to the cylinder about its axis, the vanes are deflected at unequal angles, showing unequal pressure of the air, the greatest pressure being on that side where

the cylinder remains stationary, these little vanes are inclined at the same angle toward it, but the moment a rotary motion is given to the cylinder about its axis, the vanes are deflected at unequal angles, showing unequal pressure of the air, the greatest pressure being on that side where

the motion of the cylinder and current are in opposite directions. If, for example, the cylinder be rotating from right to left toward  $a'$ , as indicated by the arrow head, the vane  $a$  will show the greatest deflection; and were the cylinder free to move like a ball, it would be pushed, out of its direction, to the left by the increased pressure on the right. This is exactly the effect which experiment shows is produced on a projectile, which has a motion of rotation like the cylinder, and in which the blast from the fan-wheel is replaced by a motion of translation of the body itself.

If the rotation be from left to right, the same effect in a contrary direction would be observed. Thus we see that if the rotation were around a horizontal axis, the effect would be to lengthen or shorten the range, to lengthen it if the front part of the ball turned from down upward, and to shorten the range if the front part of the ball turned from up downward.

326. When the velocity of the current of air is very great in proportion to that of the revolving cylinder, the direction of the vane, fig. 75, is but little different from what it was when the cylinder was stationary, whereas when the velocity of rotation is only a little inferior to the velocity of the current, one vane approaches very near to the cylinder, whilst the other recedes correspondingly. This corresponds with what is observed in practice; for the greater the velocity of rotation of a projectile in proportion to its velocity of translation, the greater will be the deviation.

The flight of a ball may be considered, then, as being more accurate during the earlier parts of its flight than it is during the latter portion of its course; for the

velocity of translation diminishing very rapidly, whilst that of rotation continues almost without alteration, the deviating influence of the rotation becomes more sensible as the velocity of translation diminishes, or as the projectile approaches the end of the trajectory.

327. That the remaining velocity of rotation in projectiles is often very great, is shown by the fact that, after losing all their velocity of translation, they are sometimes seen to roll on the surface of the ground; and if any object be interposed to arrest the rotation, that motion is destroyed, wholly or in part, and all the force inherent in the ball is exerted to disengage it, and it will be thrown to a distance sometimes of 250 yards.

328. **Eccentricity.** In casting shot, short weight often arises from large cavities formed within the shot by confined air. These cavities also cause shot to have *eccentricity*, or deviation of the centre of gravity from the centre of figure. This eccentricity is of very general occurrence, so much so that nearly every shot possesses what is termed *preponderance*, that is, one section of it will be found to preponderate over every other section, if the shot itself be floated in a bucket of quicksilver. If no preponderance can be detected by this simple and accurate mode, no appreciable eccentricity can exist, the shot is then *concentric*. The degree of promptness with which an eccentric shot, floated as above, assumes the position due to its preponderance, is regarded as the measure of that preponderance.

It was supposed that advantage could be taken of eccentricity in shot to obtain increased ranges, from the fact that when the preponderating side was placed in different positions the range was sensibly affected.

329. **Effect of Eccentricity on Range and Accuracy.** Between 1835 and 1840, a series of experiments were carried on in Belgium, with great care, and with ordnance of different calibres, from which it was ascertained that, when the centre of gravity was above that of the figure, the range was greater than when it was below; and that when the centre of gravity was to the right or left, the deviation of shot was in like manner to the right or left.

These results were confirmed by experiments carried on by Colonel Paixhans, at Metz, in 1841. The effects observed were: when the centre of gravity was above the centre of figure the ranges were the longest, and when below, the shortest; when to the right hand or left hand, the deviations were also to the right or left. The mean range with the piece of ordnance used in the experiments, which, with the usual concentric shot, was 1,640 yards, was, with the eccentric shot (the centre of gravity being placed upward), equal to 2,140 yards, being an increase of 500 yards.

330. The reasoning used above in the case of the deviations resulting from the motion of rotation of a sphere in the air applies in the case of eccentric shot to explain the causes of these results of practice. After the motion of rotation in the air is once established, it is evident that the eccentricity of the projectile will tend to increase the resulting effects of rotation beyond what they would be were the ball concentric. It is, however, necessary in the first place to show in what direction the motion of rotation is taken up. Suppose the shot laid in the gun with the centre of gravity above the centre of figure; any motion of rotation communicated

•

to an eccentric shot must take place around the centre of gravity; now it is evident that there is much more surface for the charge to act upon below the centre of gravity than there is above it, consequently the lower portion of the ball will take up a higher initial velocity than will be imparted to the upper portion; a motion of rotation is thus established around a horizontal axis, turning the front part of the ball from below upward. The shot retaining this motion on leaving the gun, the resistance of the atmosphere engendered by the rotation offers more resistance on the under side than on the upper side, the ball, inclining in the direction of least resistance, tends upward in its flight, and the range is lengthened.

In like manner it may be shown how the range will be diminished if the centre of gravity be placed below the centre of figure, the ball in this case taking up a motion of rotation around a horizontal axis, turning its forward side from above downward. The same reasoning will demonstrate that the deviation will be to the right or left, according as the centre of gravity is placed to the right or left of the centre of figure of the ball, the only difference being that in these cases the motion of rotation will be taken up around a vertical axis.

**331. Effect of Rotation on Projectiles Fired en Ricochet.** With respect to the ricochet of eccentric spherical projectiles, there can be no doubt that the rotation which causes deflection in the flight must act in a similar manner to impede a straight-forward graze. When an ordinary, well-formed, homogeneous spherical projectile, having little or no eccentricity, upon which probably very little rotation is impressed, makes a graze, the

bottom of the vertical diameter first touches the plane, and immediately the projectile acquires, by the reaction, a rotation upon its horizontal axis, by which the shot rolls onward throughout the graze favorably for a straight-forward second flight.

But in the case of an eccentric spherical projectile, placed with its centre of gravity to the right or to the left, its rotation upon its vertical axis, during the graze, must occasion a fresh deflection in its second flight, and these fresh deflections have been shown by experiments to be always toward the same side of the plane of fire as the centre of gravity; that is, if the shot was deviating to the right before the graze, the effect of the ricochet will be to continue the deflection in the same direction; and it is only when the centre of gravity is placed in a vertical plane passing through the axis of the gun, that the rotation occasioned by touching the ground or water will not disturb the direction of the graze, though the extent of range to the first graze will be affected more or less, accordingly as the centre of gravity of the projectile may have been placed above or below the centre of figure. In the former case (when placed above) the effect of the rotation, which is from below upward, tends to incline the ball to detach itself from the plane struck as soon as possible, the effect of the graze is also to make the ball bound up; these two effects conform with each other, and the result is that the ricochet when the ball is rotating from below upward does not retard the progressive motion of the ball so much as when the centre of gravity is placed down which would impart a motion of rotation from above downward. In this latter case the effect of the graze is

to make the ball bound up, but the effect of the rotation is to make the ball have a tendency to remain in contact with the plane struck, and to bury itself or to roll along on the surface; these two effects work against each other, and the result is to retard the forward motion of the projectile. In neither of these cases, however, is there any tendency to produce deflection to one side or the other, if the medium struck be a plane surface.

332. It would seem that no practical advantage can be gained from eccentricity in a projectile, where accuracy is required, in consequence of the *unequal intensity* of the eccentricity in different projectiles. In bombarding a town, where it is desirable to have great range, but when it is indifferent where you hit, eccentric projectiles might be of use, inasmuch as the extra range can be obtained by placing the preponderating side up; but in general the practical maxim, with smooth-bored cannon, holds good, that errors in sphericity and homogeneity in a shot are causes of its deviation from a correct path; and it follows that spherical and homogeneous projectiles, being the most simple, and quite in different to the position in which they are placed in the gun and rolled home, as well as to that in which they pass through the atmosphere, are decidedly to be preferred to the others.

333. **Eccentricity explaining Anomalies.** The results of these experiments on eccentricity fully explain the extraordinary anomalies, as they have heretofore been considered, in length of range and in the lateral deviations; these have been attributed to changes in the state of the air, or the direction of the wind, to differ-

ences in the strength of gunpowder, and to inequalities in the degrees of windage. All these causes are, no doubt, productive of errors in practice, but it is now clear that these errors are chiefly occasioned by the eccentricity and want of homogeneity of the shot and the accidental positions of the centre of gravity of the projectile with respect to the centre of figure. These experiments furnish decisive proof of the necessity of paying the most scrupulous attention to the figure and homogeneity of solid shot, and the concentricity of shells.

334. **Eccentricity in Shells.** In the shell it is still more evident that any eccentricity could not be controlled and turned to advantage, because in a number of shells the preponderating spot will occupy every variety of position, and as the shell must be placed in the gun in reference to the position of the fuze-hole (which, in order that it may receive the flame rushing through the windage ring, is required to be placed "up and out"), it might be found that this would involve the placing of the preponderating spot in the worst possible position. The desire is, then, to make the centre of gravity of a shell coincide with the centre of figure, and to effect this a *compensating mass* is cast about the fuze-hole.

335. **Best Position of the Preponderating Side.** From the foregoing considerations it follows that the smoother the surface of balls, and the less their windage and eccentricity, other things being equal, the greater their accuracy. And when desiring to fire with unusual deliberation and accuracy, it is proper to select shot of least windage, least eccentricity and smoothest surface; and, as it is almost impossible to obtain a ball perfectly concentric, experiments show that the preponderating or

heaviest side of the shot should be put next to the charge, in which position it interferes less with the accuracy of flight than when placed in any other.

**336. Influence of Velocity on Deviation.** It follows, also, that when a ball is deflected from the line of aim by a blow on one side of the muzzle, the less the charge of powder, the greater will be the resultant angle of deviation produced by the blow; and that, since the deviations produced by friction of the atmosphere are in proportion to the times in which that friction operates, the ball which accomplishes a certain range in a given time has but half the angle of deviation that another ball will have if accomplishing the same space in double the time. Hence, high charges and high velocities are essential to accuracy, especially in distant firing; and this constitutes the chief advantage of long guns, which bear and burn heavier charges; and accounts for the greater accuracy of larger and denser balls, which retain their velocities longer, and consequently accomplish their distances in less spaces of time.

**337. Case of no Deviation.** When the axis of revolution makes no angle with the line of flight, but coincides with it, as in the rifle ball, there is, in theory, no deviation.

**338. Advantage of Large Calibre.** The resistance of the atmosphere to two projectiles moving with the same velocity, is respectively proportional to their surface, or to the square of their diameter, while the overcoming forces of these projectiles are proportionate to their weight, or the cube of their diameter; the effect of the resistance of the atmosphere will diminish as the projectile has the greater overcoming force. In short, the

effect of atmospheric resistance upon two projectiles moving with the same velocity is in the inverse ratio of their diameters multiplied by their densities.

For projectiles of the same density, the effect of this resistance will be in the inverse ratio of their diameters; take, for example, two balls of the same density, one of 3, and the other of 6 inches diameter; these correspond nearly with 3-pounder and 24-pounder shot. The resistances to these shot are as the squares of 3 and 6, or as 9 to 36, or as 1 to 4.

Their forces to overcome these resistances are as their weights, as 3 to 24, or as 1 to 8 (also as the cubes of their diameters, 27 to 216, which is likewise as 1 to 8); in other words, the larger of these balls meets a resistance four times as great as that of the smaller, but has eight times the power to overcome the resistance, and consequently is retarded in its flight but half as much as the smaller ball; in other words, the effect of this resistance is in the inverse ratio of their diameters.

**339. Advantage of Greater Density.** For projectiles of the same diameter, but of different densities, the resistance will be in the inverse ratio of the densities, thus a shell will be retarded more than solid shot of the same diameter; finally, in order that two different projectiles shall experience the same resistance, it is necessary that the products of their diameters by their respective densities shall be equal. It results from this that a leaden ball would experience much less resistance than an iron ball of the same diameter, but balls of lead lose their form upon the first impact, even upon water, and have not a sufficient consistence to penetrate bodies which offer much resistance.

Wrought-iron balls would have an advantage over cast-iron shot, but the expensive character of this material seems to present an insuperable obstacle to adopting it for the purpose of projectiles.

340. **Advantages of the Spherical Form.** The projectiles first used in artillery were irregular in form, and consequently very inaccurate in fire, and it was not long before the advantages of the spherical form were demonstrated.

The sphere, as before stated, presents the minimum surface for a given volume; and the wind, which causes so much inaccuracy in elongated projectiles, has comparatively but little effect on the round one, which, having its centres of gravity and figure more nearly coincident than any other, presents, when it rotates, an equal surface always to the action of the air. If it strikes any object in its flight, it is less deflected from its course than one of any other form; an important fact at sea, where much of the firing must be *en ricochet*, also a very important fact in sieges, since ricochet firing is sometimes the only means of reaching an enemy behind obstacles.

341. **Advantage of the Elongated Form.** When the design is to strike an object *direct*, however, the sphere is no longer the most advantageous form. For, by making the projectile elongated and pointed, the resistance of the air is very much diminished, and additional weight can be added without increasing the cross-section of the projectile, thus increasing its power of overcoming the resistance, and favoring the penetration of the projectile when it strikes.

342. **Requirement for Accuracy with Elongated Projectiles.** Of course the elongated projectile, to be used with any advantage, must be preserved in its position of moving

through the air, point foremost; otherwise, were it allowed to take up indiscriminate motions of rotation, it would tumble over and over, sometimes presenting its point, sometimes its side, and sometimes its base, to the resistance of the air, and would describe a trajectory totally at variance with accuracy; on striking, also, it would be altogether uncertain what portion of its surface it would bring into contact with the object, thus, striking with its side or base foremost, its penetration would be insignificant. The elongated projectile is kept in the desired position of moving point foremost by determining its rotation around an axis passing lengthwise through the centre, in fact giving to it the *rifle motion*, which is effected by cutting grooves in the bore of the piece, which impart the required motion to the ball during its passage along the bore, and the ball pursues its flight through the air retaining the acquired motion of rotation. If the projectile be made of iron, it must be supplied with an outer coating of softer metal which can enter the grooves in the bore, but this subject will be dwelt on more at length under the head of *Rifles*; we remark again, however, that the use of the elongated ball must be disadvantageous if the rifle motion be not communicated to it; but this motion being established, and the small diameter only being exposed to the resisting influence of the atmosphere, the advantage derived from its increased weight is evident.

343. **Resistance to the Spherical and Elongated Shot Compared.** Taking the most approved form for elongated projectiles, the resistance to it is found to be about one-third of that offered to a spherical ball of the same diameter. The resistance to the spherical ball is one-half

of what one of its great circles would experience ; so that the resistance to a projectile moving point foremost is just one-sixth of what it would be were it moving with the base to the front. The resistance increases as the surface against which it acts becomes more nearly perpendicular to the direction of this resistance. Hence, if this projectile becomes flattened by the rammer (as in loading a musket or rifle with a leaden bullet) the resistance is very much increased.

The resistance is, however, still very great to even pointed projectiles, it being estimated that it reduced the range of a rifle bullet experimented on in France, to one-half of what it would be in vacuo.

344. One advantage possessed by the spherical figure is the manner in which it enters the gun; it rolls instead of sliding, and injures the bore less; spherical shot cannot jam in the bore, which sometimes happens with the elongated ball.

345. **Influence of Wind on Accuracy.** In addition to the injurious effects produced upon accuracy by windage and eccentricity, the action of the wind operates to interfere with the flight of projectiles; this cause produces a greater effect as the projectile increases in size and decreases in density, hence a shell will be more affected by it than a solid shot.

With elongated projectiles the wind has a greater surface to act on, and produces a greater effect than on spherical balls. Elongated projectiles are sometimes found to work up to windward instead of being driven off to leeward. This is due to the fact that the part of the ball behind, being the lightest, is most easily acted on, and being thrown away from the wind,

the point is thrown in the opposite direction, giving a deviation *toward* the wind. The deviations arising from the action of the wind are very variable, and no rules can be laid down for correcting them. Practice and close observation of the previous fires are the only correctives.

346. **Penetration of Navy Ordnance.** The following table of penetrations may be useful as a reference, as exhibiting the power in this respect of the ordnance of the United States Navy. It is the result deduced from numerous firings at a target of seasoned white oak, made at the experimental battery at Washington. The table is extracted from "Shells and Shell Guns," by Commander J. A. Dahlgren:

GUN.	CHARGE. LBS.	PROJECTILE.	INITIAL VELOCITY. FEET.	PENETRATION.			
				500 YDS. INCHES.	1,000 YDS. INCHES.	1,500 YDS. INCHES.	2,000 YDS. INCHES.
18 pdr. long	6	shot.	1,720	28.9	17.9	11.0	6.9
24 " "	8	"	1,720	33.5	21.8	14.1	9.3
32 " of 33 cwt.	4½	"	1,250	26.4	18.5	12.7	8.8
32 " of 42 "	6	"	1,450	32.0	22.0	15.0	10.3
32 " long	9	"	1,700	38.7	26.5	18.2	12.5
42 " "	10½	"	1,620	41.7	29.7	21.1	15.1
64 " "	16	"	1,620	49.9	37.3	27.9	20.8
8-in. of 55 cwt.	7	shell.	1,350	29.2	20.2	14.0	9.7
8-in. of 63 cwt.	9	"	1,500	33.2	23.0	15.9	11.0

Commander Dahlgren remarks, "the penetration of the tables assumes the surface of the object to be placed rectangularly to the direction of the line of fire; while in actual combat this will be an unfrequent occurrence; for the opposing ships will be in constant motion in order to obtain or to preserve certain advantages of position, or to prevent the attainment of them by the other party; consequently the hulls, in the great majority of cases, will be presented more or less obliquely to the direction of fire, and the effort of the ball will be unfavorably exerted on the tough and elastic fibres of

the oak, in proportion to the inclination of the surface with the direction of the ball's flight; and when this angle is reduced to  $15^\circ$  the ball glances entirely."

347. **Rockets.** A rocket for military purposes consists of an inflammable composition contained in a cylindrical case of sheet iron. The head is of cast-iron, and may be either a solid shot, or a shell with a fuze communicating with the rocket composition. The composition consists of nitre, sulphur, and charcoal. When the rocket is used merely for making signals, the composition is contained in a stout paper case, and the head, which is then conical, is filled with a composition for producing, at the explosion, the decorations, such as stars, serpents, golden rain, &c.

348. Signal rockets are usually made of two sizes, 1.5-inch, and 2-inch, and are designated by the exterior diameter of the case.

349. The *Former*, fig. 76, consists of two parts, the longest one being square at one end, and having at the other, where it is slightly rounded, a conical opening, into which fits the spindle of the second part, which is shorter than the first.

Fig. 76.



At the point where the two parts join, both being rounded, is a depression which is to form the *choke* of the rocket. The diameter of the *former* is two-thirds of the calibre of the rocket.

To make the case, the *former* is enveloped with a sheet of the proper paper, cut to the required size and pasted after the first turn. It is then placed in the press

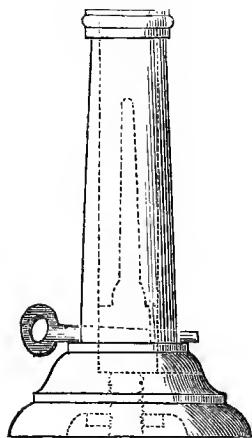
and rolled tight, after which another piece of paper is rolled, pasted, and pressed on; and so on until the proper size is obtained. The press consists of a table having grooves in the top, of a proper size to receive the cases. On top of this is placed a heavy platform with corresponding grooves, and this is hinged to the table and raised by a lever to put the cases in. The cases are then rolled by slipping a handle on the square end of the former and turning it.

350. **The Choke.** To *choke* the case, it is wrapped at the joint of the *former* with a piece of strong paper, to prevent the choking cord from chafing it. A strong, smooth cord is taken around the case at the joints of the *former*, and a strong strain is brought on it. As the paper yields to the pressure, the short part of the *former* is drawn out, until the case is sufficiently contracted, when the cord is taken off, the choke wrapped with strong twine and the *former* removed. When the case is perfectly dry, it is trimmed to the proper length, so that the distance from the middle of the choke to the bottom shall be equal to that from the bottom of the spindle to the bottom of the mould, and the remaining portion equal in length to the distance between the bottom of the spindle and top of the mould.

351. **Rocket Composition.** The rocket composition should be well mixed, by passing it through fine sieves, and rubbing it in the hands. The charcoal, being the lightest ingredient, must be added after the nitre and sulphur have been mixed; and, whilst driving, the rocket composition must be frequently stirred to prevent these heavy materials from settling to the bottom.

352. **Moulds.** Moulds, for driving rockets, are cast in

Fig. 77.



a single piece, and bored out to the proper calibre. The *spindle*, which is made of cast steel, stands on and is connected with the base, of cast iron, as is represented in fig. 77. The mould being passed down over the spindle, is secured by a pin, which runs through both.

353. **Driving the Composition.** The case is placed over the spindle, choke down, and settled with a mallet until it rests on the base of the spindle. The mould is then placed over it, and keyed to the base, which should rest on some solid foundation, as a large block of wood. The composition is placed in from a ladle, which is made of such a size as to contain enough to form a column, when driven, equal in height to one-half the interior of the case. In driving, four drifts are used, made of brass, or hard seasoned wood tipped with brass. The drifts have handles strengthened at the top by copper bands. The first drift is pierced, to receive the whole length of the spindle; the second to receive two-thirds of it; the third to receive one-third; and the fourth is solid.

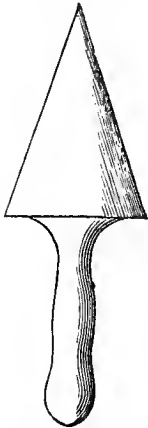
354. **Mallets.** Mallets for driving 1.5-inch and 2-inch rockets are turned, out of hard well-seasoned wood, and weigh about two and three pounds respectively. The force to be employed in driving depends on the size of the rocket, the larger receives thirty, and the smaller twenty-five blows, for each ladle full of composition. The hollow drifts are first used, the shorter ones being taken as the case fills. When the composition

reaches the top of the spindle, one more diameter is driven with the solid drift, and covered with a patch of stiff paper, cut to fit the case; and over this is driven a wad one-third of a diameter high, of clay, or plaster of Paris slightly moistened with water. This wad is afterward pierced with a gimlet through to the composition, by means of which fire is communicated to the bursting charge in the pot containing the ornaments.

Rockets are sometimes driven solid throughout, and afterward bored out with a tap of the form of the spindle.

355. **Pots.** Pots are made of rocket paper, by rolling two or three turns of it upon a former of the same diameter as the rocket case, pasting it all well except

Fig. 78.



the first turn on the former. The pot is two diameters long, and when attached to the rocket has an interior depth of one and a half diameters. In it are placed the ornaments of the rocket, and the charge of powder designed to blow them apart.

356. **Cones.** Cones are made of rocket paper, which is cut into circles of a diameter equal to twice the height of the cones to be made. Each of these circles, cut in half, makes two cones. They are rolled upon the former, fig. 78, pasted and dried.

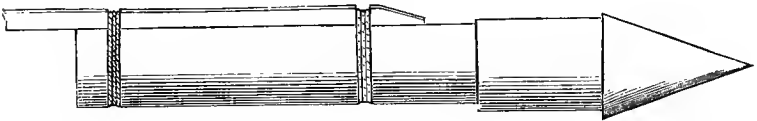
357. **Priming.** A rocket is primed by coiling a piece of quick-match, about two inches long, in the conical opening, and covering it with a cap of strong paper, pasted down or tied in the choke.

358. **Making up the Rocket.** To make up the rocket, the pot is placed in position, by pasting the upper part

of the case, and sliding it into the pot to the proper distance; or a ring of light wood may be used, which, fitting inside the lower end of the pot, is placed over the upper end of the case, by taking off several folds of the paper down as far as is necessary. The plaster of Paris covering having been pierced with a gimlet, the hole is filled with mealed powder, and the bursting charge and ornaments placed in the pot with a slight covering of tow. The cone filled with tow (to assist in resisting the pressure of the air), and with its base cut to the same size as the pot, is placed on top of the latter, to which it is fastened by pasting over it a cone made of fine paper, the lower part being cut into slips, and pasted down over the pot. A slip of fine paper is then pasted around the joint to give a finish to the rocket. The cone decreases the opposition offered by the air, and assists the rocket in penetrating it.

359. **Rocket Stick.** As a guide to the rocket, a stick made of dry pine or other light wood, and nine times the length of the case, is attached to it with twine. The large end is fixed to the case, and is bevelled off so as to decrease the resistance of the air. The side next

Fig. 79.



the case is grooved out for a distance equal to two-thirds the length of the case which fits into it. Just below the bevel, and also opposite the choke, notches are cut to receive the twine by which the case is bound to the stick, fig. 79. The other end of the stick is de-

creased in thickness to half that of the case end. The poise of rockets should be verified by balancing them on a knife-edge. Those under 1.25 inches should balance at three diameters from the neck; between that and 2 inches at two-and-a-half diameters, and larger rockets at two diameters. If the stick is too light, the rocket will not rise vertically; and if too long and heavy it rises slowly, and will not arrive at its proper height.

360. **Decorations.** Stars are the most beautiful decorations of rockets. They are made by driving the composition, moistened with alcohol and a small quantity of gum-arabic solution, in port-fire moulds, without any paper case, and with a moderate number of blows; they are cut into lengths of about three-quarters of an inch, and dredged with mealed powder. A more expeditious and better mode of making them is, to mould them in a brass cylinder of the diameter desired for the stars, and push them out with a rammer, cutting them into proper lengths as they are formed. Stars, after being dredged with mealed powder, must be dried in the shade. The gum-arabic, used in the star composition, is intended to give such consistency to the stars that the explosion of the head of the rocket may not break them in pieces, and thereby destroy the effect.

361. **Congreve Rocket.** The rod, attached to one side of the rocket, occasions irregularities in its flight, and the late Sir William Congreve, whose name is identified with this species of artillery, placed it in the direction of the axis of the rocket. This disposition, in a great measure, remedied the evil without interfering with the escape of the gas, for in the neck of British war rockets,

Fig. 80.



fig. 80 several apertures are formed for the admission of air; at one of these in which is left a piece of quick-match, the fire is applied to the composition. The rocket, when about to be fired, is fitted in a tube, which is attached in a given position, to a rest; when, on applying the match, the whole surface of the conical space is put in a state of slow combustion, and the rocket is propelled. The combustion continues until the composition is entirely consumed, the elastic gas generated by the combustion escaping through the apertures.

362. **Motive Power of the Rocket.** The propelling power is produced by the expansion of the gas generated in the burning composition; the force, thus originated, causes a pressure, outward, against the sides and ends of the rocket, but the apertures in the neck allowing the gas to escape there (being resisted only by the pressure of the atmosphere at the apertures), the pressure against that end is consequently less than that which is exerted by the gas against the head or anterior part of the rocket; and the difference between the pressures at the opposite ends is a resultant force, acting against the head during all the time that the composition is burning; this constitutes, therefore, a pressive force by which the rocket moves onward, with a motion continually accelerated, till the resistance of the air against the head becomes equal to that force, or till the composition is burned out. This action of the gas is quite analogous to that which produces the recoil of a suspended gun when fired without shot or wad.

363. **The Rod.** The rod serves to guide the rocket in its flight, the lateral resistance of the air about it preventing, in some measure, its vibrations. In a one-pound rocket, before combustion begins, the common centre of gravity of the rocket and rod is about two feet from the head of the former, and about seven feet from the opposite extremity of the latter; and then the resistance of the air, in checking the vibrations of the rocket, acts with considerable effect, like a power applied at the end of the longer arm of a lever; but, in proportion as the composition is burned out, the centre of gravity approaches the middle of the length of the whole missile; the resistance of the air is then less able to counteract the accidental deviations of the rocket itself; the head at the same time begins to droop, and at length the whole comes obliquely to the ground. It has happened, even when the angle of elevation was small, that the weight of the rocket preponderated so far over that of the rod as to cause the missile to come to the ground in a direction tending toward the spot from whence it was fired.

364. **Range.** Signal rockets, whose diameters vary from one to two inches, will ascend vertically to a height of five hundred or six hundred yards; and those whose diameters vary from two to three inches, to a height of twelve hundred yards. A 12-pounder rocket, fired at an elevation of  $16^\circ$ , and a 6-pounder rocket at an elevation of  $14\frac{1}{2}^\circ$ , range about twelve hundred yards. The distances at which the explosion of rockets has been seen vary from forty to fifty miles.

365. **British Rockets.** The use of rockets was first introduced into the English military service by Sir

William Congreve. This officer caused them to be made to serve as shells or carcasses, and their weights, for these purposes, were 3, 6, 12, 24 and 32 pounds. When fired against timber or earth they penetrate to considerable depths. A 12-pounder rocket, after a range of 1,260 yards, has been known to enter to the depth of twenty-two feet into earth.

366. Every shell rocket in the English service is fitted at its head with a fuze, screwed into the base of the shell. The fuze is as long as the size of the shell will admit of, so as to leave sufficient space, between the end of it and the inner surface of the shell, for admitting the bursting charge; and the end of the fuze is cupped, to serve as a guide in the insertion of the boring bit, when it is desired to shorten the time of burning of the fuze by perforating the composition. There is a hole in the upper end of the shell, secured by a screw metal plug, for putting in the bursting charge, and for boring according to the different ranges at which it may be required to burst the shell.

If the rocket is to be used as a shell rocket, at the longest range, the plug is to be taken out, and the shell filled, the fuze left at its full length, and the plug replaced. If at the shortest range, the fuze is to be entirely bored through, and the rocket composition bored into, to within one inch and a half of the top of the cone, in the 24-pounder rocket, and to within one inch in the 12, 6, and 3-pounder rockets.

367. **Uncertainty of Rocket Practice.** Experiments on shell rocket practice show the great uncertainty of that practice against troops in the field; and to this uncertainty must be added the liability of the sticks to

be broken on grazing the ground when fired at low angles.

The forward motion of a rocket is impeded by the resistance of the air at the head, and by the action of gravity. Again, in firing across the wind, the action of the air upon the stick causes the rocket to come up more to the wind instead of being driven bodily to leeward, and the stronger the current of air is, the more the rocket points toward the quarter from whence the wind comes. When the rocket is fired against the wind the range is considerably shortened, and, when fired with the wind, it is lengthened. Thus, in firing across the wind, some allowance must be made for its effects, and the rocket must be pointed by so much to leeward of the object; in firing against the wind, greater elevation than that which the distance requires, must be given; and, in firing with the wind, less elevation must be given, but the amount of these allowances can only be assumed approximately, according to an estimate of the strength of the wind, and therefore the practice must be uncertain.

368. **Limited Usefulness of Rockets.** Rockets may be used, with some advantage, against cavalry, from the scaring effects of the blazing projectile upon horses; also against large masses of infantry; but they are totally inefficient in firing at small objects. Many exaggerated opinions were once entertained of the efficiency of this weapon, and it was believed that rockets would supersede the use of artillery in the land service; but these opinions have generally sobered down to the idea, now prevalent, that they are only substitutes for field guns when these cannot be brought up.

369. **Incendiary Property of Rockets.** The most efficient

use, however, that can be made of rockets is as an incendiary projectile, to set fire to towns or single buildings. From their want of penetration, rockets are powerless against the strong materials of ships of war, but they may be used against places on the sea-coast, to protect landings, and against crowds there assembled. For this purpose, in the English Navy, they are plentifully supplied to small steam vessels, which have light draught of water, and approach close to an enemy's coast. Rocket firing, however, from ships is a very dangerous practice; the first rush of back fire, before the rocket starts, is capable of igniting any combustible body upon which the flame may act.

370. **Trajectory of the Rocket.** The great uncertainty of rocket practice will be obvious from considering the causes which produce its trajectory. When it first starts from the tube, its velocity is so small that it is not sufficient to prevent the fore part of the rocket from drooping or dipping below the axis of the tube; the actual angle of departure, therefore, is less than that at which the tube is set, and allowance for the error can only be made by a vague estimation. As the rocket proceeds, its velocity increases, and is supposed to be greatest at one-third or one-half the range. The common centre of gravity of a rocket and its stick, on starting, is situated near the propelling power, and the vibrations of the rocket during its flight take place about that point; this point is, however, continually changing its place in proportion as the composition is consumed, and this change causes continual irregularities in the deviations of the rocket during its flight. When the composition is entirely burned out, the rocket proceeds under

new and very different conditions; so that upon the whole it is utterly impossible to lay down the trajectory of a rocket, or to obtain good and sufficient rules for conducting the practice with that arm.

371. **Rockets Fired from Cannon.** The idea has been started of late of combining the rocket with a piece of rifled ordnance, projecting it from the piece with a velocity sufficient to overcome all causes of deviation and inaccuracy which obtain at the commencement of the rocket's flight, and enabling it to range to much greater distances. Mr. Greener writes, "My experience with rockets goes to justify me in asserting that rockets discharged from a gun, under certain circumstances, can be as effectually controlled, and kept to a direct course, as a bullet fired from a rifle. The rocket, however, may be fired a much greater distance than we have ever been able to project a bullet; because, in addition to the force which projects it from the gun, its flight is maintained by the self-sustaining agency in the body of the rocket. Rockets require a much smaller charge of powder to project them than that which is required by a ball. A rocket, started by its own force, expends, in acquiring even an approximation to its highest velocity, at least one-third of the force with which it is charged; but when projected by a small charge of gunpowder this force is saved, and the flight of the rocket is afterward sustained by the force with which it is charged.

"Firing rockets from cannon can only be practised under certain circumstances. A rocket suitable for artillery should be cast of gun metal, with a frame of considerable strength; the composition should be more densely driven than is customary in the ordinary rocket;

the outer frame of the rocket should be cast with suitable projections to fit the grooves cut in the bore of the gun; the twist of these grooves should be considerable, as much as one turn in every three feet, in order to impart to the rocket an effectual spinning motion when in a low state of velocity. The rocket, properly constructed, is then placed in the rocket gun, and fired in the usual way; but it is essential that the gunpowder used should be of a suitable quality; its combustion must be as slow as possible, a starting velocity of from five hundred to eight hundred feet per second being sufficient to insure the flight of the self-sustaining projectile to the end of its range."

372. **Hale's Rocket.** A very ingenious method of dispensing with the stick of the rocket has been proposed by Mr. Hale of England; and, having been experimented on by a board of United States officers, has been adopted into our service. This consists in causing the rocket to rotate on its axis during its flight, and, as in the case of an elongated shot, move steadily with the point foremost. For this purpose instead of permitting all the rush of flame to escape from the bottom orifice in a line with the axis of the tube, a portion of the inflamed gases issue from five orifices made near the neck, *obliquely* to the axis of the tube, the effect of which is that the body of the rocket is made to rotate while it is also propelled. In the experiments made with these rockets several modes of directing them have been tried; first, by firing them from a small trough formed of wood in two inclined planes; secondly, from a frame carrying two portions of rings, which grasp the body of the rocket, and retain it in one position until it has acquired,

after ignition, sufficient force to overcome the pressure of a spring below it; this force, suddenly releasing the body from the rings, permits the rocket to escape with a velocity sufficient to prevent the usual droop or dip mentioned before.

373. The appearance of the original Hale rocket was the same as the Congreve rocket, to which the

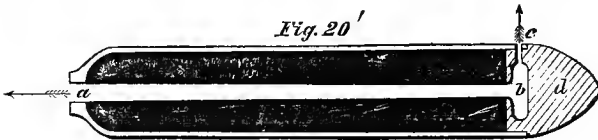
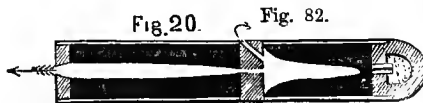


Fig. 81.

stick has not yet been attached, but it has undergone some modification since its first introduction. At present the tangential holes, of those in our service, are three in number, and, instead of being situated posteriorly at the neck of the rocket, are placed as far forward as the rear of the solid head, fig. 81, the perforation in the composition extending through the entire length of the case, and a small chamber being provided, within the rear part of the head, for the accumulation of the gas which issues through the tangential holes.

374. The English Hale rocket, fig. 82, has the tangential holes also moved forward, they are two in number; but the interior arrangement differs from that now in use in our service, in that the perforation in the composition is divided into two compartments by means of a diaphragm



of iron which extends transversely across it, and which has a small hole through it coincident with the axis of

the case. The anterior chamber is exclusively concerned in furnishing gas for supplying the two tangential holes, while the posterior chamber is devoted to the evolution of the flame of propulsion. The use of the hole through the axis of the diaphragm is to obviate the necessity of igniting the rocket in two places.

375. **Hale's Rocket Tube for Broadside Firing.** Mr. Hale went so far in his enthusiasm in connection with his rocket, as to propose it for the armament of ships; and, recognizing the injurious effect of the back fire which makes this weapon so dangerous in use on board ship, he devised a tube for broadside rocket service. It resembled a large tubular letter U, resting upon one bend, with both its heels sticking out of the port; by this device the back fire would be directed toward the enemy, and the rocket, acquiring strength, was to find its way around the U tube and fly in the direction of the enemy.

376. The Hale, like all other rockets, is liable to one very great objection, that is, that after the composition is burned out, it loses its directing power, because the rotation ceases when the composition is consumed; no accuracy can, then, be expected from it beyond the distance it has reached when the composition ceases to burn.

## CHAPTER VII.

## FUZES.

377. A Fuze is a contrivance by which fire is communicated to the bursting charge in a shell. Fuzes are divided into three classes, viz.: the common or time fuze, the concussion fuze, and the percussion fuze.

378. **The Time Fuze** consists of a column of inflammable composition which, being ignited by the charge in the gun, burns for a certain space of time, at the end of which it communicates its flame to the bursting charge in the shell.

379. **The Concussion Fuze** consists of an arrangement of inflammable composition, which is ignited by the charge in the gun, and in which the flame, by means of some interior contrivance, is admitted to the bursting charge in the shell at the moment of its striking the object.

380. **The Percussion Fuze** receives no flame from the charge in the gun; but, at the moment of impact, a flame is generated, by means of fulminates, which produces the explosion of the shell.

381. **Fuze-Case.** The Fuze-case is a tube of suitable exterior and interior dimensions, for containing the fuze composition, which is compressed in it either by a drift and mallet, or by the force of a press; the press used in the manufacture of the fuzes for our navy shells exerts a force of about 2,200 lbs.

The oldest form of fuze-case was of wood, fig. 83, and consists of a conical plug of wood of the proper size for the fuze-hole of the shell with which it is to be fired. The axis of this plug is bored out cylindrically, from the large down to within a short distance of the small end, which is left solid. At the large end a cup is hollowed out, and the outside of the plug is divided into inches and parts, generally tenths, commencing at the bottom of the *cup*. The cylindrical space



is filled with composition, pounded or pressed hard as stone, the composition being solidified until its density is doubled, and the cup filled with mealed powder, moistened with whiskey or alcohol. The rate of burning is determined by experiments, and marked on a water-proof paper cap, which is tied over the cup. Knowing the time any shell is to occupy in its flight, the fuze is cut off with a saw, or bored, at the proper division, and firmly set in the fuze-hole with a mallet. If the wooden case should be set at an angle with the axis of the piece when fired, the jar of propulsion might bend it, thus breaking the column of composition, and cause a premature explosion of the shell by exposing an increased amount of surface to the flame; in order to guard against this accident, it is necessary to place a wooden fuze-case in the axis of the bore.

382. **Metallic Fuze-Case.** It is very desirable, however, that the fuze-hole of the shell should be placed up in the bore, in order to insure the inflammation of the fuze by the flame rushing through the windage ring; in order the better to achieve this object, and also on account of the rapid deterioration of wooden cases, we

have adopted in our naval service a metal fuze-case composed of copper and tin; and the better to guard against the effect of moisture and against any chemical action that might be excited thereby between the composition and the metal, the composition is first driven in a paper case which is afterward inserted in the metallic case. The metallic case is better able to resist the tendency to bend, which is induced by the effort of the shell to take up suddenly a rapid motion, and can be placed in that position in the bore where it is most certain to receive the full benefit of the flame. The fuze is generally\* placed *up and out*. The metallic fuze-case of the navy is of such a length as to extend very little, if any, inside of the metal about the fuze-hole; in the 8-inch shell the fuze-case is supported by the metal of the shell throughout its entire length. The fuzes of the United States navy are divided into five, ten, and fifteen seconds, a certain proportion of each being supplied to each shell gun.

383. **Paper Case.** The paper case is made of stout paper cut in slips of the required size, having one end square and the other tapered to a point. The paper is rolled up on a cylinder of the required interior diameter of the case, and cemented where the surfaces come in contact. The taper with which the paper is cut gives a less exterior diameter at the bottom than at the top of the case.

384. **Safety Plug.** Before the composition is driven or pressed into the case, a safety plug is inserted which consists of a short solid cylinder of lead, surmounted by a shorter hollow cylinder of the same material and of the same diameter as the plug which it surmounts. The

\* The fuze in 9-inch, 10-inch, and 11-inch shells is placed in the axis of the bore.

plug being inserted, and the solid portion of it projecting below the tapering end of the case, a drift is introduced which, resting on the edge of the hollow cylinder or cylindrical cavity, is struck a smart blow with a mallet, which, flattening out the sides of the lead, causes it to bind against the interior of the paper case, thus closing the end of the case, and preventing the issue of flame through that end of the case as long as the plug remains fixed. The shell, with its fuze fitted with the safety plug, should be safe even were the fuze to be ignited on deck, but the jar of concussion, consequent upon the explosion of the charge in the bore, is so great as to detach the plug from the case at the moment that the shell commences its flight, so that from the moment the shell leaves the gun the communication is open between the burning composition in the fuze and the bursting charge in the shell, and as soon as the composition is consumed the shell will explode.

385. **Water Cap.** The paper case, after the composition is driven, is cut off to the required length and placed firmly in the metallic case. After the paper case is placed, a contrivance, called a *water cap*, is screwed in over the composition; this contrivance has for its object the preventing the entrance of any matter, such as sand or water, over which the shell may ricochet, and is primed on its outer surface with a little powder and strands of quick-match. Over all is placed a leaden patch which securely guards the priming against moisture, and which must be removed at the time of entering the shell in the bore, or the shell will not explode.

386. **Paper Cases.** The paper case is sometimes used without being inserted in another case, but is, at the

time of firing, inserted in the fuze hole, into which it is firmly set by blows of a wooden mallet, the fuze-hole having been previously bouched with wood or lead. When the fuze-hole is bouched with wood, the plug should be bored with a small drill at first, then driven in, and the hole afterward enlarged to receive the fuze; were this precaution not taken, the plug would shrink and fall out. This use of the paper case was made with the United States boat howitzer ammunition, to every round of which a package was supplied containing five fuzes, marked respectively in black circles around the case one, two, three, four and five seconds. The paper cases in use in the army are distinguished by the color, thus:

Black	burns	2	seconds	to	the	inch.
Red	“	3	“	“	“	“
Green	“	4	“	“	“	“
Yellow	“	5	“	“	“	“

Each fuze is made two inches long, and the yellow burns consequently ten seconds. This arrangement is very objectionable as it involves the exercise of memory in selecting the color that may be required for immediate use.

At present the paper case is almost entirely superseded by the Bormann fuze in the ammunition for the boat howitzers.

387. **Fuze-Cases of other Nations.** The fuzes of the English Navy have the metallic case; but the French still adhere to the wooden case, from the belief that the metal case, being raised to a high temperature by the burning composition may explode the bursting charge thus causing premature explosions. The Russians early

adopted the metallic case, and proved at Sinope both the terrific power of shells and the good quality of the fuzes.

388. **English Fuze.** The English fuze cases are made of brass, and are of three sizes, according to the calibres with which they are used. They differ from those of the U. S. Navy in having no safety plug, and no water cap. During the flight of the shell, the composition in the fuze is unprotected from the entrance of sand or water, over which it may ricochet, and is liable to failure from this cause; Sir Howard Douglas states that four fuzes out of five are extinguished on striking the water, and about one in three on striking a ship. The fuze composition, however, is protected from moisture &c., by a brass cap which screws on outside the fuze case over the composition; this cap is unscrewed by the loader at the time of entering the shell in the bore of the piece, and to guard against the danger of loosening the fuze case in the fuze-hole, the screw for the fuze case and that for the cap are cut in opposite directions; the effect, then, of unscrewing the cap is to tighten the fuze case in the shell. The thread on the case, however, projects beyond the surface of the shell after the cap is unscrewed, and must disturb the flight of the shell.

389. **Injuries from Shocks.** It has long been recognized as a fact, that the fuze composition, driven in a wooden or metallic case, tightly fitting the fuze-hole of the shell, is liable to many injuries from shocks in and out of the bore, by which the composition is broken and cracked in such a way as to give passage to the flame, and cause premature explosions. Various means were

adopted to overcome this difficulty, and, among others, may be mentioned the cutting the inside of the case into grooves like a screw; and afterward in the form of rings not communicating with each other, as the screw shape was found sometimes, after the wood had shrunk, not to fulfil the object.

Such a defect was more especially noticed in shrapnel shells, the thin sides and short bearing surface for the fuze in them causing the shocks to be more forcibly transmitted to the composition.

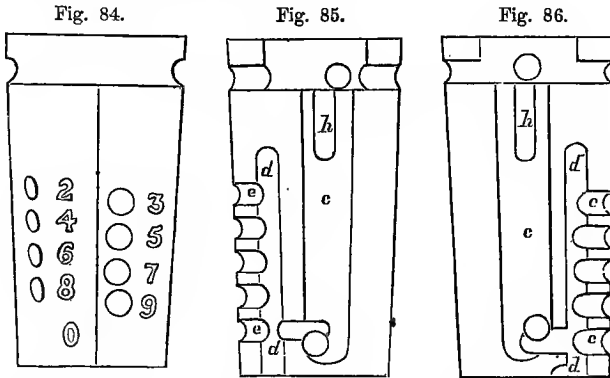
The conical form of the paper fuze case, and the bouching in the fuze hole, of the shrapnel supplied to the Navy howitzers obviates this objection in a great measure, but a more elaborate system of protecting the fuze from the injurious effects of these shocks was invented by Captain Splicingard of the Belgian Artillery.

390. **Splicingard Shrapnel Fuze.** The Splicingard shrapnel fuze consists of two parts; the fuze, properly so called, and the fuze-plug. The first is a small cylindrical tube of hammered copper, the upper end of which swells out so as to form a kind of cup to hold the priming, and prevent the case from being driven into the shell when the piece is fired. This tube is filled with composition in the usual way, a conical opening, one-tenth of an inch high, being left in the bottom, in order, when the flame reaches that point, that a larger surface may be ignited, thus rendering more certain the explosion of the shell.

The fuze-plug is made of wood, and fits the fuze-hole. The opening in the fuze-plug is in two parts, the upper conical in shape widening downward, the other cylindrical, and only a little greater in diameter than the copper

fuze, and much less than the upper part of the opening. The upper part is fitted with a cork, having an opening just large enough to allow the entrance of the fuze. The elasticity produced by the presence of the cork is the distinctive feature of the fuze.

### 391. Boxer's Fuze.



The fuze used by the English in connection with their diaphragm shrapnel, is the invention of Captain Boxer, the superintendent of the Laboratory Department at Woolwich, and is represented in figures 84 85 and 86.

Figure 84 represents the fuze for spherical case, full size, and figures 85 and 86 sections of the same. The channel for composition (*cc*) is bored eccentric with regard to the exterior, and the two powder channels (*dd*) are bored on the thickest side. The exterior taper of the fuze is one-tenth of an inch to one inch. The fuze composition is made to burn one inch in five seconds. The upper part of the bore is charged with mealed powder, and a hole (*h*) is bored through this priming to a depth of 0.4 inch from the top to insure the ignition of the fuze. The figures marked on the fuze indicate tenths of an inch below the bottom of this hole, show-

ing the points at which the fuze is to be pierced, according to the required time of burning; the greatest length being one inch or five seconds. At each of these points a hole (*e*) is bored into the powder channel (*d*). The exterior of the fuze is covered with paper pasted on and varnished. The lower hole (*e*) is pierced through into the composition. The other holes are filled with pressed powder and a little clay. In the bottom hole a strand of quick-match is inserted, which serves to retain the charge in the powder channel of the fuze. This quick match is continued from one channel to the other through a groove in the bottom of the fuze.

A metallic cap covers the top of the fuze. Under this cap is placed a disk of pasteboard to which a piece of tape is attached to facilitate the uncapping of the fuze.

When the fuze composition has burnt down to the hole, which has been bored through at the time of loading, the powder in the side channel is ignited, and the flame from the bottom of the fuze communicates, through a small groove, to the bursting charge.

To *fix the fuze*: the hole to regulate the time of bursting is bored, according to the range required; the fuze is then placed in the bouche in the fuze-hole, and struck with a mallet; the cap is not removed until the shell is placed in the muzzle of the gun, to protect the fuze from accident or wet.

These fuzes have given great satisfaction by the regularity and certainty of their effect, but seem to be open to objection on the score of complication; no reason is apparent why they should buru any more regularly than the common paper fuze, which was

formerly supplied to the U. S. Navy boat ammunition, whilst the certainty of exploding the shell appears to be quite as great with these last, which also must be much the cheaper.

**Objection to Fuzes driven in the Direction of their Length.**

There exists an objection to all fuzes compressed in the direction of their axis; as, it is urged, it is impossible to obtain perfect uniformity of combustion where the density of the mass is not uniform throughout. Fuze compositions, driven in the direction of the axis of the fuze, must have the lower layers more dense than the upper layers, in that the lower layers, in addition to the pressure which they receive on being driven, must receive an additional pressure from the power which is exerted to compress the superincumbent layers. If the composition be consumed in the same direction in which it was compressed, it is evident that there must result irregularities in the duration of burning. The most important invention, having for its object the correcting this defect in fuzes, is the Bormann fuze, invented by Captain Bormann of the Belgian Army.

392. **Bormann Fuze.** The essential improvement involved in the Bormann fuze consists in applying the

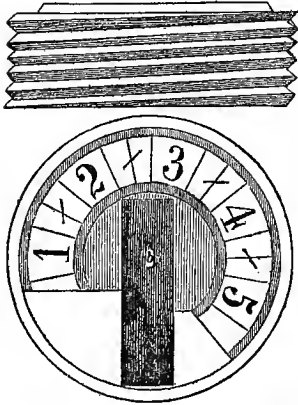
Fig. 87.



pressure to the composition on the side, and burning it from the end. The fuze case, fig. 87, is made of metal (a composition of lead and tin), and consists, first, of a short cylinder, having at one end a horse-shoe shaped indentation, one end only of which com-

municates with the magazine of the fuze placed in the centre. This horse-shoe indentation extends nearly to the other end of the cylinder, a thin layer of the metal

Fig. 88.



only intervening. This is graduated on the outside into equal parts, representing seconds and quarter seconds as represented in fig. 88. In the bottom of this channel a smooth layer of the composition is placed, with a piece of quick-match underneath it. On this is placed the piece of metal represented in fig. 89, the cross section of it being wedge-shaped ; and this is, by machinery,

pressed down upon the composition, sealing it hermetically. The cylindrical opening, represented at G, fig. 87, is filled with fine powder, and covered with a piece of lead, which is soldered in its place, closing the magazine from the external air.

Fig. 89.  
TOP VIEW



SECTION



On the side of the fuze the thread of a screw is cut which fits into one cut on the inside of the fuze-hole, and the fuze is screwed into the shell with a wrench, the projecting part of which fits into the indentation at *b*, fig. 88.

The thin layer of metal over the composition is cut away with a gouge at the interval marked with the number of seconds which we wish the fuze to burn. The metal of this fuze being soft, there is danger of its being driven into the shell by the explosive force of the

charge. To prevent this, a circular piece of iron, of a less diameter than the fuze, with a hole through its centre, and the thread of a screw on its outside, is screwed into the fuze-hole before the fuze is placed in.

393. **Operation of the Fuze.** This fuze operates in the following manner; the thin covering of metal over the composition being cut at the required graduation, exposes the surface of quick-match which was placed in the horse-shoe indentation before the composition was pressed in; the composition is thus ignited by the charge in the gun, and it burns in both directions. The portion of the flame, which advances progressively with the graduation, is extinguished as soon as it reaches the termination of the channel in that direction; but the portion of the flame which burns toward the origin of the graduation communicates, through the connecting channel, with the powder in the magazine, which communicates the flame, through the hole in the circular piece of iron, to the bursting charge in the shell, by blowing out the piece of lead soldered over the magazine.

394. **Advantages of the Bormann Fuze.** The regularity and certainty of this fuze are very great; and its use has, so far, been principally confined to light artillery in firing shells, and particularly shrapnel, in which these two requisites are so essential; but it has been applied to larger ordnance with every promise of complete success.

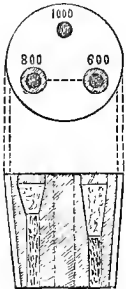
One of the most important advantages of this fuze is the fact that the shells can be loaded, all ready for use, and remain so any length of time, perfectly safe from explosion, as the fuze can be screwed into its place, and the composition never exposed to external fire until the

metal is cut through. The only operation, then, to be performed under fire is to gouge through the metal at the proper point, which may be done with any kind of chisel, knife, or other instrument.

395. **Tests.** The severest test to which this fuze has been subjected was in a series of experiments carried on in France, during which a number of shrapnel, with the fuzes not cut for bursting were fired and afterward recovered, and again fired with the fuzes properly cut. The results demonstrated that the fuzes resist completely all the shocks which the projectile receives, either when in the bore or when ricocheting on the ground, without injury and without detaching itself from the shell. In order to demonstrate this fact more clearly, several shots were fired with a *rolling fire* (en ricochet), without cutting the fuzes, and the same fuzes were fired over again after duly regulating them, giving the most satisfactory results.

396. **French Shrapnel Fuze.** The French, however, not having paid much attention to the perfecting of shrapnel shot, are not known to have adopted the Bormann fuze; in fact the only fuze that we have any account of as being applied to shrapnel by that nation is the one

Fig. 90. represented in fig. 90.



The French shrapnel fuze is made of hard wood, having three channels parallel to its axis. These are filled to different heights with composition, corresponding thus to three different bursting distances. Each of these channels is provided with a tin tube in which the composition is placed.

The longest channel is always left open. The other two are closed with a covering of leather, over which is placed, for the shorter columns, a disk of rose-colored paper, for the other, one of blue. On these paper coverings are marked the distances at which the columns will cause explosion. These distances are also placed on the face of the fuze near the top of the channels.

The fuze is capped with a rondelle of fringed paper, over which is placed a plain rondelle of parchment with a piece of tape attached, by means of which the fuze is uncapped. The proper channel is opened, and should a mistake be made, and the wrong one opened, it is only necessary to moisten the leather and replace it, opening the right one.

The composition in the three channels burns in  $1\frac{1}{2}$ ,  $2\frac{1}{2}$ , and  $3\frac{1}{2}$  seconds.

It is proposed to modify the fuze by adding a fourth column, intended to burst the shell at only 250 yards' distance, but at this short distance canister shot will do quite as well as, if not better than, shrapnel.

This fuze possesses one important advantage; it may be regulated very promptly by men who do not know how to read. It might even be regulated in the dark by replacing the different colored paper disks by knots fixed to the priming cord.

397. **Concussion Fuzes.** Many and various attempts have been made to construct fuzes which, from the shock of a shell when striking, will communicate fire to the charge and explode it. A concussion fuze, as already defined, consists of an arrangement of inflammable composition, *which is ignited by the charge in the gun*, and in which the flame, by means of some interior contri-

vance, is admitted to the bursting charge in the shell at the moment of its striking the object.

Such a fuze, in order to be serviceable, must not only produce explosion on striking, but it must not produce it from the shock of the explosion of the charge in the gun, nor of that produced by the ricochets of the projectile in or out of the gun. These fuzes have usually consisted of some combination of the highly explosive fulminates. But the extreme danger of using these, and the fearful accidents which they are liable to cause, have been great obstacles to their adoption.

398. The definition for a concussion fuze, as given above, is not without its objections; as undoubtedly the name is just as applicable to any other arrangement, *not including a burning fuze*, which sets fire to the charge on striking. The distinction is made for the sake of convenience, and only such as are described by the definition will be included under the head of *concussion* fuzes.

The attempts made to construct these fuzes date from a very early period; and probably many of these attempts, although partially successful, never became known, on account of the very general disposition to keep secret such inventions, in order that the authors of them might derive all the benefits resulting from their discoveries.

399. **Early Attempts at Invention.** As early as the year 1637, mention is made of shells which took fire on striking the ground; and at various periods since that time such shells have been experimented upon, many having the part near the fuze-hole made heaviest, from the belief that impact could be thus determined at this

point. Could this principle have been carried out with any thing like certainty with the spherical ball, the whole problem of concussion, or rather that of *percussion*, fuzes would have been solved, for as soon as it is possible to determine the impact at a certain point, the simplest dispositions of fulminates can be made in order to generate a flame. But in experiments made with shells, reinforced at the fuze-hole in order to give preponderance at that point, it was found that the shell struck the target with the fuze-hole to the right, left, or rear, quite as frequently as to the front. The moment, however, that the principles of the rifle are applied to large guns, so as to project elongated projectiles point foremost, the means of exploding shells on striking, or at a very short time after striking, become as simple as those used to fire off a musket.

It is not necessary to describe all the different attempts made to attain the desired object. Many of them proved successful, so far as the arrangement of the fuze was concerned; that is, the shells exploded when they happened to strike in a certain way; but the great difficulty still existed of compelling them to strike in that way.

400. In this country, an ingenious contrivance has been suggested and experimented on for some years, though, it is believed, with no very decided success. It consists of a bronze fuze-case, solid at the outer end, and having in the body a square apartment, from which a vent leads into the interior of the shell. The sides of this little chamber are lined with a coating of percussion powder, with the exception of the parts in the angles, and a small portion of each of the faces which are

perpendicular to the axis of the fuze-case. In the face farthest from the head of the case, a small threaded hole is placed, for the purpose of holding in position a little metal ball with a threaded stem attached. This stem is screwed into the hole, the inner end of the plug being movable for this adjustment; the shell is attached to a sabot with the fuze-hole to the *rear*. When the shell is fired, the little ball breaks loose by the shock, strikes against the opposite face, where there is no fulminate, and drops into the lowest part of the chamber of the fuze, where it rolls about until the shell strikes, when the concussion between it and the fulminating powder produces the explosion.

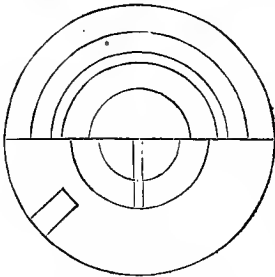
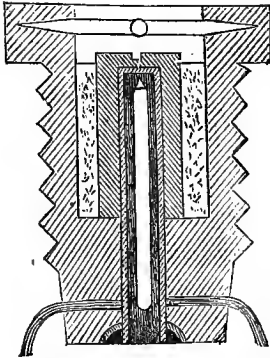
This fuze is open to the objection of all fuzes in which percussion powder is used. It requires great nicety of adjustment to insure the breaking loose of the ball from its stem; and if this last is too small, the ball may break from its position whilst the shell is being handled, and produce serious accidents.

This fuze would be, under the definition, not a concussion, but a percussion fuze; and it is mentioned here merely in giving a history of the different inventions for making shells explode on striking.

401. **Prussian Fuze.** From 1841 to 1847, numerous experiments were made in Prussia upon a concussion fuze invented in that country; and although the success obtained with it has not been such as would warrant a very strong recommendation in its favor, a description of it may not be unproductive of benefit.

The exterior aspect of the fuze-case is the same as that of the U. S. Navy fuze; the interior of the case, however, is divided into two cylindrical parts, the upper cylin-

Fig. 91.



der having a considerably greater diameter than the lower one. In other words, the perforation in the case commences with a cylinder of a certain diameter, and continues for a certain distance, when it is suddenly contracted, forming a ledge in the interior of the case, and is continued through as a cylinder of less diameter. See fig. 91.

402. The percussion apparatus consists of a small glass tube, hermetically closed at both ends, partly filled with concentrated sulphuric acid, and wrapped with cotton thread soaked in a composition composed of

70	parts,	by	weight,	of	chlorate	of	potassa,
10	"	"	"	"	flowers	of	sulphur,
20	"	"	"	"	white	sugar,	pulverized,

sifted and moistened with alcohol.

This covering is put on of such a thickness that the tube can just be inserted in a paper case which serves it as an envelope, and which is entered in the lower cylinder of the fuze-case, a portion of it projecting above the ledge which unites the two cylindrical parts. A *breaker* of lead, shaped like a thimble, is placed over the upper part of the tube which projects above the ledge, the base of the breaker resting upon the ledge.

The explosive apparatus being in position, there remains between the thimble and the sides of the fuze-

case a vacant space, which is filled with compressed meal-powder filled in by means of a hollow drift, the interior diameter of which is a little greater than the diameter of the thimble. When the composition reaches the top of the thimble, uncompressed meal powder is filled in to the top of the case.

403. Should the firing take place under such short ranges as to run the risk of not consuming all the composition by the time the shell strikes the object, the time of combustion is shortened by piercing the composition with a small auger, in a direction parallel to the side of the thimble, and to the depth deemed necessary; or the rate of burning of the composition may be increased for short ranges by mixing with it  $1\frac{1}{2}$  per cent. of pulverized charcoal.

404. On being fired, the thimble or breaker, being supported by the composition around it, is not disturbed. But as this takes fire like an ordinary time fuze, and burns down to the bottom of the breaker, it leaves this unsupported; and if the composition is all consumed when the shell strikes the object, the shot causes the breaker to rupture the glass tube, setting free the sulphuric acid, and exploding the shell.

405. The same objections may be urged against this fuze as against all those in which fulminating powder is used. It is of delicate construction and very dangerous, at least appears so to any one not experienced in its use, whilst the experiments made with it are far from demonstrating its success.

406. **Schonstedt Fuze.** In 1852, Captain Schonstedt, of Holland, invented a fuze very similar in its action to the Prussian, but had the advantage of acting both as

an ordinary time fuze and as an explosive one, and in having neither fulminating powder nor sulphuric acid in its construction. The principal points of difference between the two will be readily seen by inspecting

Fig. 92.

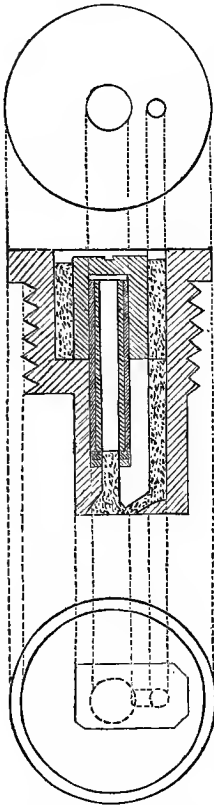


fig. 92.

The case is made of a mixture of lead and tin, and the bottom part of it is made thick enough to allow the cutting of a side-channel which enters the central one near its end.

The *breaker* is similar to the one in the Prussian fuze.

A tube of glass, open at both ends, and wrapped so as to fit, as in the Prussian fuze, takes the place of the closed tube.

The side-channel is filled with ordinary fuze composition, and the space around the thimble with a composition which burns out in two seconds.

The glass tube is filled with fine powder, and a strand of quick-match, the lower end of which last is inserted in the mouth of the side-channel, where it enters the central one.

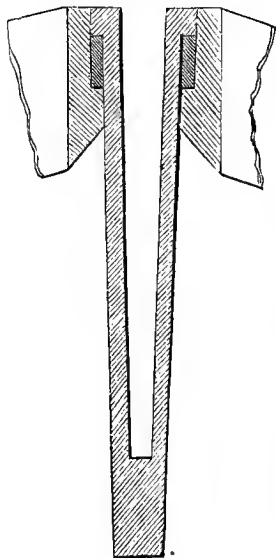
When the shell is fired, the quick composition takes fire, and being consumed in two seconds sets fire to that in the side-channel, at the same time that it leaves the breaker unsupported. This upsets by the shock of striking, and the flame in the side-channel, communicating with the powder and quick-match in the broken

glass tube, explodes the shell. In case the explosive apparatus does not act, the shell acts like one with a time fuze, and explodes when the side-channel composition burns out.

Although this fuze has the advantage of dispensing with the dangerous contrivance in the Prussian fuze, the results obtained are not as satisfactory as those with the latter, and are not of such a nature as would recommend it as a reliable concussion fuze.

407. **Snoeck Fuze.** This fuze, the invention of Cap-

Fig. 93.



tain Snoeck, of the Netherland Artillery, was tried in Holland in 1854. Its construction is based upon the property which cast zinc possesses, of being hard and tenacious at ordinary temperatures, but very brittle when heated to from  $417^{\circ}$  to  $482^{\circ}$  Fahr. Hence, a zinc fuze might resist, when cold, the shocks of the charge and balloting in the bore; but, when heated sufficiently by the burning composition, would break from the shock of the impact of the projectile, and communicate fire to the charge.

The fuze consists of a short wooden fuze-plug, fig. 93, fitted in the interior with a cork collar, through which the fuze passes; and the fuze proper, which consists of a zinc tube of a truncated conical form, having at the top a projecting band, which secures the tube in its position, and at the bottom a solid part, which, by its weight, assists in breaking the

tube when the shell strikes the object This tube is filled with ordinary fuze composition.

Many improvements are suggested to this fuze, by adopting which it is supposed it might have proved a valuable and useful invention; but a more perfect concussion fuze than any that had preceded it becoming known, experiments on the Snoeck fuze seem to have ceased.

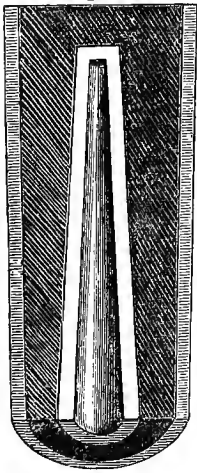
408. **Spingard Concussion Fuze.** The more perfect concussion fuze alluded to, and which possesses qualities superior to all others, is the Spingard Concussion Fuze.

This fuze, invented by the same Belgian captain whose admirable system of time fuzes has been already described, first became generally known in 1850, although it had then been invented twenty years. During this period the knowledge of it was retained in Belgium as a state secret; and it would probably still have remained such but for the corruption of some agent not proof against the inducements offered to divulge it. It became known in England and Holland, when it was deemed advisable by the Belgian government to allow a description of it to be published; which was done, as much as any thing else, for the purpose of forestalling the action of the speculators, who sought to sell the secret to foreign governments.

409. The fuze is characterized by its simplicity, and easy manufacture, by its general application to all shells, and by the total absence of all those dangerous fulminating powders so generally used in concussion and percussion fuzes.

The fuze consists of two parts, the fuze proper, fig. 94,

Fig. 94.



and the fuze-plug. The fuze-case is made of cartridge paper, nearly cylindrical in form, and filled with the ordinary fuze composition, in the centre of which is a hollow conical cavity of plaster of Paris, open at the bottom, through which passes the flame when the cone, left unsupported by the burning away of the composition around it, breaks off from the shock of the impact of the projectile.

A strong paper is used, and is rendered incombustible by immersion in a solution of sulphate of ammonia. The fuze is filled, like a rocket, on a spindle, using small charges, and taking care to pack the composition well; or it may be driven solid and bored out afterward. In the bottom part of the fuze a slow composition is used, next to that a quicker one, and in the top part mealed powder.

The surface of the opening in the composition is covered with one or two coats of gum-lac varnish. When this is perfectly dry, plaster moistened with water is packed into the opening, so as to fill it completely; and while it is still soft, a small spindle is thrust in along the axis to such a depth as not to pierce the top of the cone.

The slow composition extends only a very little above the top of the plaster tube, in order to leave it unsupported very soon after fire is communicated to that part. In this way, the same fuze may be employed, either at very small, or at very great distances.

The fuze-plug is of wood, and of the same form on

the exterior as an ordinary wooden fuze. The interior is formed of three parts:

1st. The upper and largest part, in which is fitted a cylindrical collar of cork, through which the fuze is passed, and held in its position there by friction, isolated from contact with the rest of the fuze-plug. This arrangement protects the composition from the shocks of the discharge and ballotings in the bore.

2d. The middle part, which slightly exceeds in diameter the diameter of the fuze-case; and

3d. The lower part, which is very narrow, with the double object of allowing the passage of the flame into the shell, and forming an offset for the lower end of the fuze to rest upon.

The fuze-plug being fixed beforehand, the fuze is not introduced until just before firing. For the operation, no tool is required, it being pushed in simply with the hand.

410. **Effect of a Shell Dependent on Penetration.** It is evident that the effect of a shell upon the side of a ship must, in a great measure, depend upon the depth to which the shell has penetrated; if the shell should only lodge in the outer planking and there explode, the effect would be superficial, and not much injury would be done to the ship; if, however, the shell were to penetrate to such a depth as to imbed itself in the side, the effect of the explosion would then be the greatest possible. The argument made against the use of concussion and percussion fuzes on board ship is that, if they answer the requirements of a fuze of this description, causing the shell to explode on impact, the effect of the shell must be superficial, as the shell will explode before it has penetrated to any considerable depth.

411. This argument would be conclusive against the use of concussion fuzes, if the explosion took place simultaneously with impact, but it has been shown that a certain length of time is always required to elapse between impact and explosion, and during this interval the shell penetrates to a considerable distance. In the case of the Splingard concussion fuze, it was shown by experiments made in 1853, with long guns of large calibre and high charges, fired against heavy targets of timber, that the time which elapsed between the striking of the projectile, the breaking of the tube, the transmission of fire to the charge, and the explosion of the shell, is precisely what it ought to be, in order to allow the shell to become properly imbedded in the wood.

412. **Objection to Concussion Fuzes.** Notwithstanding the advantages that do, without doubt, attach to the Splingard concussion fuze, it is proper to state, in justice to the time-fuze, that the shell fitted with the concussion fuze cannot be expected to operate inboard of the enemy, for the explosion will occur somewhere in the side. This limits the operation of the concussion system to the side; while the shell fitted with the time-fuze, may explode in the side, or, having traversed the side, may explode inboard, cutting down guns' crews, disordering machinery, and even blowing up magazines.

413. **Percussion Fuze.** The percussion fuze receives no flame from the charge in the gun; but, at the moment of impact, a flame is generated, which produces the explosion of the shell. Fuzes of this character have usually been constructed by making use of some of the dangerous fulminating powders; but even those which

have given the greatest promise of success, have this great objection against them, and are of a complicated and delicate construction. The English and French navies are both provided with a percussion fuze, but not to the exclusion of the time-fuze.

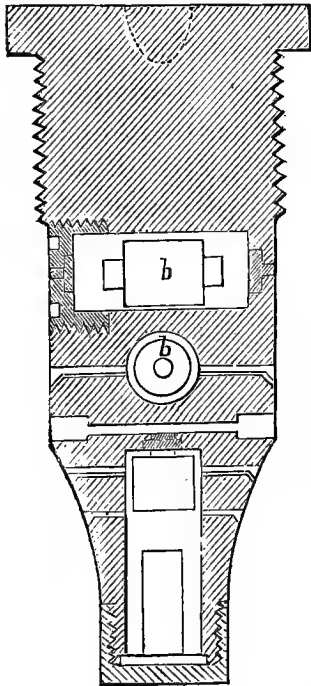
414. **Moorsom's Fuze.** The French percussion fuze is the invention of Captain Billette, but, as there are not many of them supplied to their ships of war, it is natural to infer that their advantage is questioned.

The English percussion fuze is the invention of Captain Moorsom of the English Navy, and seems to have been more successful than any other percussion fuze ever applied to spherical shells.

The body of the fuze is made of bronze, and is screwed into the fuze-hole of the shell by means of a key fitting into two mortises made in the head. The lower part is not threaded, and projects into the chamber of the shell.

In the body of the fuze, two cylindrical chambers are placed, one above the other, with their axes perpendicular to each other. In fig. 95, which represents a section of the fuze through the axis, the upper chamber is shown by a section through its axis, the lower one by a section perpendicular to its axis. These chambers are both

Fig. 95



alike, with similar percussion apparatus; so that a description of one will answer for both.

In the chamber is placed a solid cylinder of bronze, *b*, terminating at each end by a small projection or piston. One head of the chamber is movable, and when screwed into its place, its exterior is flush with the convex surface of the fuze. Holes are left on the exterior for the use of a key, and the head is screwed in after the hammer is placed in the chamber and suspended. In each end of the chamber is a small recess, a vent being bored through to it from the exterior of the fuze. These are both filled with fulminating powder.

A hole is drilled through the hammer at its middle point, and perpendicular to its axis, and is used to suspend the hammer, by means of a copper wire, in the centre of the chamber. The wire passes through corresponding holes in the body of the fuze, and is soldered at the ends in the curved portions of the holes near the surface of the fuze.

In the lower end of the fuze, a third chamber is placed, with a percussion apparatus similar to the preceding, acting, however, in the direction of the axis of the fuze, and having but one end of the chamber provided with percussion powder, the vent leading from which communicates with a cross channel, having at each end a small chamber filled with powder. The hammer, a cylinder of bronze, with a piston like the others on its upper end, is suspended in the same way, by a copper wire passing through holes in the fuze, and soldered like the rest.

At the bottom of this last chamber stands a cylinder of lead, fixed in its position by its base, which is pressed

into a little offset between the bottom end of the fuze and the cap which closes the chamber.

415. When the shell strikes, the suspension wire of that hammer whose axis coincides with the diameter of the shell passing through the point of impact, or is parallel to it, is torn loose, releasing the hammer, and allowing it to plunge forward and explode the fulminate, by striking it with the piston on its end.

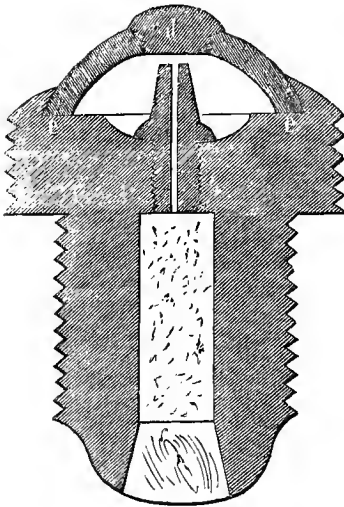
It is doubtful, even when the shell strikes in the most favorable way, if the action of the hammer is sufficiently powerful to always produce explosion; and, in support of this opinion, it may be mentioned that Sir Howard Douglas states that, in course of practice, it was noticed that they frequently failed to act even when new. Several 8-inch shells struck a hulk and passed without exploding; and many of the fuzes were picked up entire among the splinters and fragments. He adds, however, that the problem is prosecuting with every prospect of success.

For elongated projectiles, having the rifled motion, which move point foremost, and are always sure to strike at one place, the problem is an easy one of solution.

416. **Bourbon Fuze.** The Bourbon Fuze, which is represented at fig. 96, is spoken of as being the type of all good fuzes for percussion projectiles. It consists of a bronze fuze plug screwed into the fuze-hole of the shell, with a head larger in diameter than the other part, and threaded on the exterior, by means of which a cap is screwed on, covering the fuze until just before it is used.

A cap of copper, *e e*, is fixed to the head of the

Fig. 96.



fuze. A threaded hole is placed at the highest point of this cap, in which the fulminating cap, *d*, is screwed just before the fuze is used. A steel nipple is screwed into the body of the fuze just under the cap, which, when the cap is exploded, conveys fire to the charge, communicating it first to the powder contained in the channel of the fuze. The bottom of this chan-

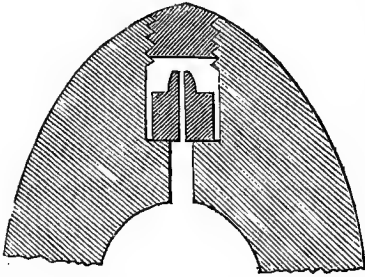
nel is closed with a cork stopper, which is blown out when the powder in the fuze takes fire.

The projectile, being supposed to strike with the point first, the shock, in order to explode the cap, must be of sufficient force to flatten the cap, *e e*; and this cap has been made of such a thickness that nothing less than striking against the side of a ship, or other equally resisting body, is sufficient to cause explosion. No ricochet, therefore, on water will cause the shell to burst.

417. Should it be found that shells armed with such fuzes burst too soon after striking, a small piece of fuze composition could easily take the place of the powder in the fuze, and delay the explosion of the shell any desired length of time; and this modification may be applied to any percussion fuze of this kind. It is now, however, pretty well established that the shell penetrates a sufficient distance to produce the proper effect, before the explosion takes place.

418. In experiments made at West Point on elongated rifled projectiles, the exploding apparatus consisted simply of a nipple attached to a piece of metal, and having on it a common percussion cap, see fig. 97.

Fig. 97.



This was dropped into a small chamber left in the point of the projectile, and a head piece screwed on. When the shell struck, the nipple piece continued to move to the front until arrested by the head piece of the chamber, when the cap was exploded, and fire communicated to the charge. This gave a little more time for the projectile to penetrate than is allowed by the Bourbon fuze, and sometimes the shells appear to have passed through a solid target of beams three feet thick, bursting as they reached the opposite side. The destruction produced by a projectile bursting in this way, after passing through a ship's side, would be very great, and would resemble that produced by the aid of the time-fuze.

## CHAPTER VIII.

## LOCKS AND PRIMERS.

419. **Early Methods of Firing Cannon.** The means first used to communicate fire to the charge in the gun, were of course of the most primitive kind. Loose powder filling the vent, and the application of a coal of fire, were probably the first employed.

420. **Match.** The first step in the way of improvement for firing cannon, was the match, or slow-match to distinguish it from the quick-match. The vent was filled with powder, and a train laid on the vent-piece toward the muzzle; the object of this train was to avoid subjecting the match to the action of the blast through the vent, to which it would have been exposed if the match had been applied directly at the vent.

Slow-match is made of hemp or cotton rope, about .06 in. diameter, with three strands, slightly twisted. Cotton rope, well twisted, forms a good match without any preparation. To prepare hemp rope, boil it ten minutes in water holding in solution one-twentieth of its weight of sugar of lead, or let it remain in the cold solution until it is thoroughly saturated; run it through the hands, to take the water from it; twist it by means of a winch; smooth it by rubbing; stretch it on poles to dry, and put it up in coils of twenty-five yards each. Match, so prepared, burns four inches to the hour. Plain

cotton match four and a half inches to the hour. Slow match, in burning, forms a hard-pointed coal, which readily communicates fire to any inflammable material with which it is brought in contact. A portion of this rope was supplied to each gun, the rope being wound around its wooden *staff*, which, having a point of iron, could be stuck in the deck or in its *match-tub*, which was an appendage formerly supplied to all guns, answering the double purpose of holding the match staff, as well as water for the gun's crew to drink during action.

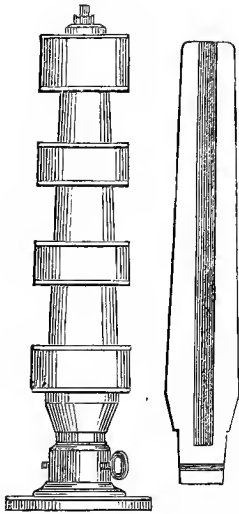
421. **Port-fire.** The match being considered very slow in its action, and it being very desirable that there should be no delay between the ignition of the priming and the explosion of the charge, the *port-fire* came to be much used for firing cannon, the match being retained in order to ignite the port-fire.

A port-fire consists of a small paper case, filled with a highly inflammable composition, the flame of which is very intense and penetrating, and cannot be extinguished with water; thus, in order to stop the combustion in a port-fire, it was always necessary to cut it off, as near as possible to the flame.

The case is made on a steel former, twenty-two inches long and half an inch in diameter. The paper being cut to the proper dimensions, is rolled on the former.

The composition is made of nitre, sulphur, and mealed powder. The port-fires are driven in a mould, fig. 98, made of brass, and in two parts, held together by a socket at the foot, and four strong bands. The bore in the mould is of the same length and diameter as the case. It having been put together, the case is put in position and the bands driven firmly down. Three drifts, of

Fig. 98.



different lengths, made of steel and tipped with brass at the lower end, are used for driving port-fires. The composition is introduced in small quantities, and the blows, struck with the mallet, are so arranged as to produce, as far as practicable, a uniform density. The shorter drifts are used as the case is filled up. Port-fires should not be primed. Before the driving is commenced, a piece of paper is introduced in the case, and driven like a plug at the bottom with the long drift; and, when the case is full to the top, it is turned in, and beaten down, thus securing both ends.

422. **Priming.** The operation of priming cannon by filling the vent with powder from a flask, was slow, and objectionable for other causes; to obviate these objections there was introduced, for the purpose of priming, a quill priming tube, which, being filled with an inflammable composition, was placed in the vent, and a priming of loose powder poured on top, forming a train, as before described, to keep the match from being affected by the blast. These tubes are made from quills, by cutting off the barrel at both ends, and splitting down the large end, for about half an inch, into seven or any other odd number of parts; these are bent outward, perpendicular to the body of the quill, and form the cup of the tube. Fine woollen yarn is then woven into these slits, like basket-work, fig. 99, the end being brought down and tied on the stem. The body of the tube is filled

Fig. 99.



with a composition of mealed powder moistened with camphorated alcohol, until a thick paste is formed ; the composition is introduced into the quill by pressing the lower end into the paste, thus taking up a portion of it, and repeating this operation until the quill is filled. A strand of quick-match, two inches long, is now laid across the cup and pasted in there with the powder pastè. A small wire is then run through the axis of the tube, and allowed to remain there, until the paste is dry ; it is then withdrawn, leaving the composition perforated throughout its entire length. This is called *pierced composition* ; the object of piercing the composition is to expose more surface to the action of the flame ; the ignition of the whole contents of the quill is thus rendered instantaneous, whereas, if the flame were required to ignite the composition through successive strata, much more time would be required to communicate the flame to the cartridge.

423. **First Application of Locks to Cannon.** This system of priming with the tube, and firing with the match was continued for many years. The first application of locks to cannon was made, as stated by Sir Howard Douglas, by Sir Charles Douglas, who, disappointed in having his propositions on this subject adopted by the Admiralty, out of his own funds bought a sufficient number of common musket locks to provide the entire battery of









Fig. 100.

*Navy Flint Lock.*



Fig. 102.

*Hiddens Navy Rebounding Lock.*

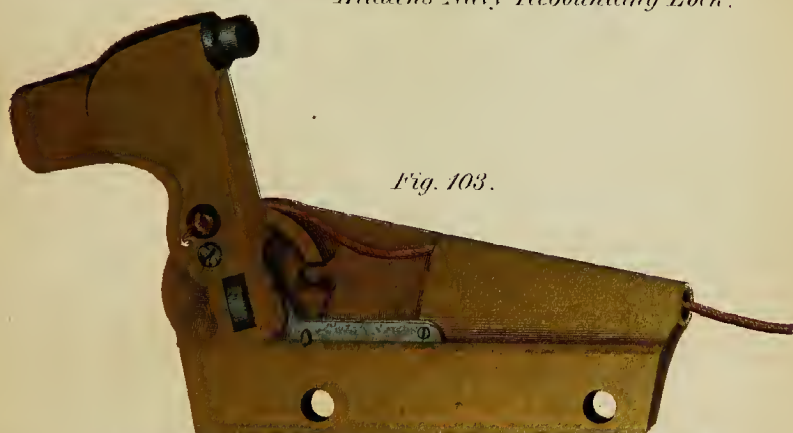


Fig. 103.

*Hiddens Navy Lock of 1840.*

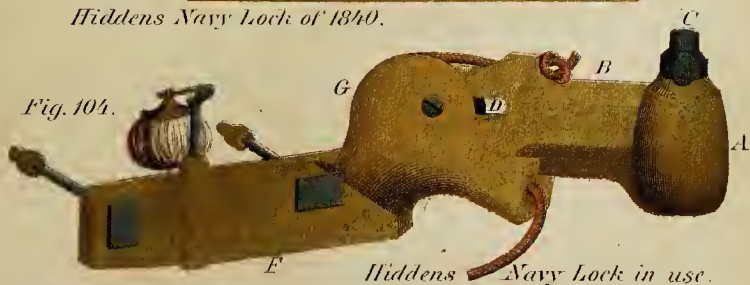


Fig. 104.

*Hiddens Navy Lock in use.*



hammer constructed on this simple principle was, in 1832, introduced into the French service by Colonel Jure and is yet the regulation lock of the French navy.

Fig. 101.

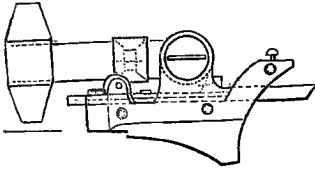


Figure 101 represents the French naval lock, which, rebounding from the blast of the vent, is caught, at its *shank*, on a cushion provided for the purpose.

425. **Percussion Wafer.** The earliest percussion primers in use were made in the form of a wafer; this wafer was placed in the vent of the piece, the metal of the gun being cut away in such a manner as to form a recess at the exterior orifice of the vent, in which the wafer was deposited, and was thus exposed to the direct action of the hammer. In spite of the apparent stability of the primer in this recess, it was found that the concussion of the air, caused by the discharge of other guns on the same deck, caused the wafer to leave its seat. An ingenious appendage intended to obviate this difficulty was attached to the *lock plate*, which is shown in figure 102, plate V. When the primer was placed in the vent this flat piece of metal, pivoted at one end on the lock plate, was moved so as to lie over the vent, thus preventing the wafer from jumping up; as the hammer descended, the shank came in contact with a vertical projection from the flat piece of metal; this projection had its side inclined, which produced a horizontal movement of the flat piece of metal, thus uncovering the primer as the hammer descended. This appendage answered very well the object for which it was introduced.

426. **Percussion Cap.** Another plan for obviating the tendency of the wafer to jump out of the vent, was to change the form of the primer, substituting a cap for a wafer, and placing it on the *nipple* of the hammer; this method obtained in the U. S. service, and was, for some time, the regulation primer of the U. S. Navy.

427. It will be seen that as soon as the percussion principle was adopted, all parts of the previous system disappeared; thus the tubes, which had established the communication between the priming and the charge, were dispensed with, it being thought that the flame of the fulminate was sufficiently intense to reach the cartridge without the aid of any connecting medium. The direct manner, also, in which the hammer struck over the vent had a tendency to determine the direction of the flame downward. This seems to have satisfied the requirements of priming for guns of small calibre; but, as the calibres were increased, the distance between the primer and the charge increased, and it was found necessary to restore the tube, placing on its top, or cup, an explosive wafer. This is the form of the present primer of the U. S. Navy.

428. **Navy Percussion Primer.** The quill is prepared as has already been described in the tube with pierced composition; except that, in place of the basket work of woollen yarn, a perforated disk of paper is pasted under the prongs of the quill, and the pointed end of the quill is not cut off; fine-grained powder is substituted for the pierced composition, and a piece of writing paper is placed over the upper surface of the prongs, covering the powder in the quill, and preventing the detonating composition from entering the quill. The

explosive compound is the fulminate of mercury, mixed with a certain proportion of mealed powder, which is added in order to give body to the flame, that of the fulminate alone being too volatile. The advantage of charging the tube with grained powder, instead of composition, consists in its greater power to resist the effect of moisture.

429. **English Primer.** The English still retain the pierced composition, and deposit their fulminate in a smaller quill, which being passed through the larger quill near its upper end, at right angles to its axis, causes the primer to assume a cruciform shape. This form of primer enabled them to discharge the piece without bringing the hammer down on the vent, it being only necessary to crush the fulminating powder in one end of the cross-head; but a great advantage, in causing certainty of ignition, was lost by the hammer not acting directly over the vent, tending to drive the flame downward; this last objection seems to have more than counterbalanced the advantage claimed before for the system; for Sir Howard Douglas, writing on the subject, says "This construction was found to be so sluggish as not to accomplish the great desideratum in naval gunnery, which is, that the firing of the charge and the actual delivery of the shot from the gun shall take place as quickly as possible after pulling the trigger-line, in order that there may be little time for any alteration to take place, from the motion of the ship, in the aim of the gun. Thus it was necessary to devise some means by which the hammer, *after having struck fairly upon the head of the tube placed in the vent*, should instantaneously slip or be drawn aside, so as to

be out of the way of the explosion through the vent. Various modes of effecting this have been devised in the British and in other naval services, but the most efficient and simple implement of this nature is that which was invented by an American named Hidden, and patented in 1842."

430. **Navy Locks.** This allusion refers to the present U. S. Navy lock which will be described farther on, and which has been adopted, with some alterations made by Colonel Dundas, into the British Navy; but this lock was not the first one invented by Hidden, with a view to avoiding the effect of the blast. His first effort was to remove the hammer laterally from the vent, as shown in fig. 103, plate V.: as the hammer descended, through the action of the lock string and gravity, a projecting shoulder on the *lock lug* caused the hammer to fall at an angle with the lock plate, directly on the vent, thus exploding the primer; the shank, at this point, was found below the shoulder on the lug, and, the action of the lock string continuing, its effect was to remove the hammer laterally from the vent, bringing the shank parallel to the lock plate, thus avoiding the blast. This lock was very successful and was provided to batteries in the U. S. Navy in 1842.

431. The inventor continued his investigations, and in 1842 patented the lock referred to by Sir Howard Douglas, which, for simplicity and practical usefulness, stands without a rival. This lock is represented in fig. 104, plate V.

- A. The head of the hammer.
- B. The Shank.
- C. An iron nipple.

D. A slot in the shank of such a length as to allow the hammer to recede one inch.

F. The lock-plate by which it is attached to the lock piece.

G. The lock-lugs, forming the bearings for the axial bolt.

The action of this lock may be described as follows. The first effect of the lock string is to cause the hammer to turn on its axial bolt, which it does until arrested by striking the primer; the action of the lock string still continuing, the effect is to withdraw the hammer *directly* from the vent, and this effect is permitted through the instrumentality of the slot in the shank, the motion continuing until the bolt comes in contact with the opposite end of the slot.

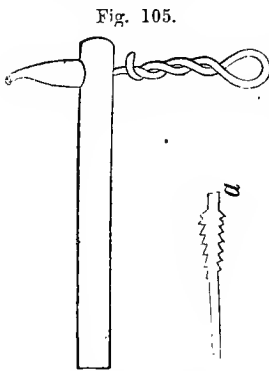
432. **Late Improvement in Mounting the Hammer.** In cannon of new construction the lock-piece is dispensed with, and lock-lugs are cast on the guns on each side of the vent. This arrangement admits of much simplification in the lock, dispensing with the lock-plate and the lugs upon it. The lock becomes a simple hammer with a slot in the shank, and is secured by its axial bolt to the lugs on the gun. The action of the lock string is also made more direct by placing the lock lugs to the rear of the plane passing through the vent at right angles to the axis of the piece.

433. **Friction Primers.** Friction primers are now almost exclusively used for firing pieces in the field,

\* An objection to this plan is, that the shank and lock-lugs, being of different metals, expand unequally. At the late bombardment at Hatteras, the shank of the lock of one of the 10-inch guns expanded so much as to make it necessary to remove it from the gun and to file it down.

and could they be adopted on board ship, a still farther simplification in the firing of cannon could be brought about, as the locks could then be dispensed with.

The friction primer, now used in our army, is represented in fig. 105, the tube being made of sheet brass,



with a wire flattened at one end and made rough and serrated, *a*, for the purpose of acting on the friction powder. The extremity is annealed in order to make it soft enough to bend without breaking. The large tube is filled with the pierced composition, and the short tube with a mixture of two parts of chlorate of potassa

and one of sulphuret of antimony moistened with gummed water. A string is hooked to the eye, made by doubling the wire, and the friction of the rough end of the wire against the friction powder produces a flame which explodes the piece.

The objection to adopting these primers on board ship, is the damage that may be done by the flying of the brass tubes, which issue from the vent with great force when the piece is discharged; in action, also, the crew generally dispense with their shoes, and many might be seriously disabled by the sharp pieces of brass lying on the deck under their feet. The advantage to be derived, however, from a successful application of the system is pretty generally acknowledged, and efforts have been made to overcome the objectionable features of it.

434. **English Friction Primer.** Fig. 106, plate II., represents the English friction primer which has been ex-

perimented on in that service. The tube is a quill, but as the material has not sufficient strength or firmness to resist the force of the pull necessary to withdraw the friction wire, a loop of leather is attached to the quill which passes over a knob or projection cast on the gun just forward of the vent. The quill is destroyed by the combustion of the charge, and all accidents from the flying of the tube are obviated. The leather loop, however, is perishable, and does not last for any length of time; some other material will have to be substituted in its place. A solution of the problem is being attempted in that service, and it is said that it is also to be attempted in our service.

## CHAPTER IX.

## THEORY OF POINTING GUNS.

## PRELIMINARY.

435. **Gravity.** All bodies fall when they cease to be sustained; this general property of bodies is called *gravity*.

436. **Vertical.** Vertical is the direction that bodies follow in falling; this direction is indicated by the plumb line. We know, in fact, that a heavy body, suspended at the extremity of a flexible line, should draw this line in the same direction in which it would fall, if left free.

437. **Horizontal.** All planes, perpendicular to the vertical, are called horizontal planes. Horizontal planes may, therefore, be at any height whatever.

438. **Resistance of the Air.** When we observe the fall of bodies, we remark that those which have a large surface with little weight, such as paper, leaves of trees, feathers, &c., fall slowly; whilst those which have a considerable weight, without presenting much surface, such as stones, metals, &c., fall rapidly. This difference arises from the unequal resistance which they encounter from the air, resistance which evidently ought to vary with the extent of surface upon which it is exerted.

439. **Familiar Illustration.** To prove that this difference arises only from the resistance of the air, we intro-

duce two very different bodies, a feather and a piece of lead for example, into a long glass tube; from this tube we exhaust the air by means of an air pump, and then permit the bodies to fall; we find that they fall with equal rapidity.

440. **Velocity of a Falling Body.** The velocity of a falling body does not remain constant during its fall. We know that the blow produced by a heavy body is stronger in proportion to the height from which it falls. This comes from the fact, that the velocity which has been communicated to it by its gravity is greater in proportion to the time it is falling.

At the instant the body commenced its fall, its velocity was nothing; from this moment its velocity goes on augmenting progressively in a continuous manner.

At the end of one second, its velocity is 32.18 feet per second; at the end of two seconds, its velocity is 64.36 feet per second; at the end of three seconds, its velocity is 96.54 feet per second, and so on in like manner, adding 32.18 feet with each second of time; that is to say, *the velocity of falling bodies increases proportionally to the times.*

If we represent by  $g$  the velocity that a body has at the end of the first second, falling in a vacuum; and if we represent by  $v$  the velocity it has at the end of any number of seconds represented by  $t$ , the above law may be represented by the equation

$$v = g t. \quad * \text{ Smith's Mechanics art. 22}$$

Thus the velocity acquired by a body falling in a vacuum during 7".5 is, at the end of that time

$$v = g t = 32.18 \times 7.5 = 241.37 \text{ feet per second.}$$

These results are given by experiment; but they can,

very readily, be established by a course of reasoning. Thus, gravity acts constantly on all material particles; when a body is sustained, the constant effort of gravity is continually destroyed by the resistance of the obstacle which opposes its action; hence comes the *pressure* which heavy bodies exert upon the obstacles which prevent them from falling; it is this pressure which constitutes their *weight*. When a body ceases to be sustained, gravity puts it in motion, and as this continues to act upon it while it is in motion, it impresses upon it at each instant the same increase of velocity; it follows, therefore, that the total velocity which it impresses upon the body must increase proportionally to the time during which it acts.

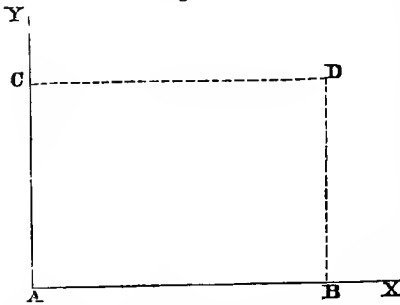
441. **Disregarding the Atmospheric Resistance, all Bodies Fall with Equal Rapidity, Irrespective of Weight.** Let us take two bodies perfectly equal; gravity acts upon them in the same manner. If we permit them to fall during the same times, their movements should be identical; consequently if they are together when they are abandoned to the action of gravity, they will remain together throughout their fall. It follows that their common movement would not be altered if they were joined together; but, in that case, they would form but one body, of which the weight would be evidently double that of either taken separately.

442. The above remark applies to any number of bodies. Hence, if we suppose a body divided into any number of equal parts, the velocity impressed by gravity upon all the parts taken together is the same as would be impressed upon each of the parts taken separately; from which we conclude that, in a vacuum, *grav-*

ity impresses always the same velocity upon all bodies, irrespective of their weight.

443. When we know the Law which governs the Velocity of a falling Body, we can calculate the Space that the Body passes over in a given Time. We remember that when the velocity of a body remains constant during its entire movement, the space passed over by the body is proportional to the product of the velocity by the times. Thus, for example, if a body moving with a constant velocity of 5 feet per second, continues to move for 7 seconds, the space passed over is represented by the product  $5 \times 7 = 35$  feet. This result may be represented by a diagram thus (fig. 107): upon an indefinite line A X,

Fig. 107.

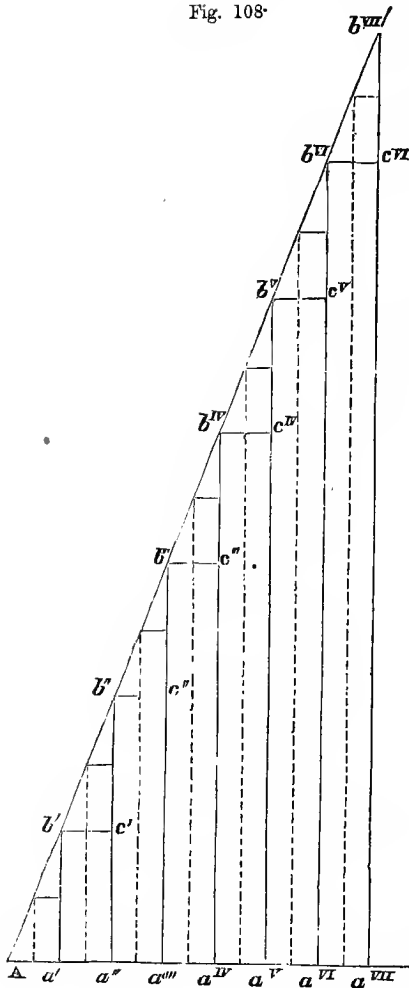


take a length A B, proportional to the time, that is, which contains the unit of length as many times as the duration of motion contains the unit of time. At the point A, erect a perpendicular A Y, and

take upon this perpendicular a length A C proportional to the velocity; finally construct the rectangle A B D C upon these two lines. The surface of this rectangle is measured by  $A B \times A C$ ; it is proportional to the space passed over, that is, it contains the unit of surface as many times as the space passed over contains the unit of length.

444. Let us next suppose that the velocity does not remain constant during its motion; but that it varies in a continuous manner, proportionally to the time. Upon

Fig. 108.



the indefinite right line A X, fig. 108, take lengths proportional to the time; thus A a' corresponds to one second; A a'' to two seconds, &c.; then, suppose that a line should move along A X, remaining constantly perpendicular to it; suppose also that the length of this perpendicular should vary proportionally to its distance from the point A, in such a manner, that at the distance corresponding to one second it should be equal to 32.18 feet; at the distance corresponding to two seconds to 64.36 feet, &c. It

is evident that the lengths of these perpendiculars, corresponding to different distances measured upon the line A X, represent the velocities acquired at the end or different times corresponding to these distances.

As the perpendicular a' b', a'' b'', a''' b''', are proportional to the distances A a', A a'', &c., the extremities

of all these perpendiculars are upon the same straight line.

445. The space passed over at the end of a certain time, is proportional to the surface of the triangle which has for its base the length which represents the time  $t$ , and for its height the perpendicular which represents the velocity acquired at the end of the time  $t$ : Thus, for example, the space passed over at the end of 7", is represented by the surface of the triangle  $A a^{VII} b^{VII}$ .

To prove this, suppose that instead of the velocity varying continuously, it should receive increments suddenly and only at sensible intervals, remaining constant from one interval to the next. If, for example, it should receive an increment of 32.18 feet at the end of each second, the space passed over during the first second would be nothing; the space passed over during the second second would be represented by the surface of the rectangle  $a' b' c' a''$ ; the space passed over during the third second would be represented by the rectangle  $a'' b'' c'' a'''$ , &c.; it follows that the total space passed over during the seven seconds would be represented by the sum of the rectangles just indicated. This sum is evidently less than the surface of the triangle.

446. Now if we suppose that the velocity, in place of varying at each second, should receive increments at the end of each half second equal to  $\frac{1}{2}$  of 32.18 feet, the space passed over would be represented by the sum of the smaller rectangles whose bases are half the intervals used as bases in the preceding case. It is easy to see that the sum of these new rectangles differs less than the first from the surface of the triangle. In like manner, by again subdividing the spaces, and using the corresponding

velocities, we continue to approximate to the triangle  $Aa^{VII} b^{VII}$ , until finally when the subdivisions of the intervals are infinite, that is, when the increments are made continuously and without intermission, the aggregate will be equal to  $A a^{VII} b^{VII}$ . We hence conclude that when the velocity varies in a continuous manner, the space passed over is correctly represented by the surface of a triangle whose base represents the time employed, and height the velocity acquired at the end of the time.

But the surface of a triangle is measured by the half product of its base by its height; in this case the base is proportional to the time of the fall; the height is proportional to the velocity acquired at the end of this time; therefore,

*The space passed over by a body falling during a certain time is measured by the product of the time and half the velocity at the end of this time.* Calling  $v$  the velocity acquired at the end of this time  $t$ , and  $h$  the space passed over during the same time, we have

$$h = \frac{1}{2} v t,$$

but we have found for the expression of the velocity acquired at the end of the time  $t$ ,

$$v = g t;$$

substituting this value for  $v$ , we have

$$h = \frac{1}{2} g t^2. \#$$

447. We see from this expression that (since  $\frac{1}{2} g$  is constant) *the spaces passed over by a falling body, are proportional to the squares of the times during which it is falling.*

448. We see, then, that the space through which a body falls during the first second is equal to

# See Smith's mechanics. vol. 257 p 153

$$\frac{1}{2} g = \frac{32.18}{2} = 16.09 \text{ feet;}$$

the space fallen through in two seconds is equal to

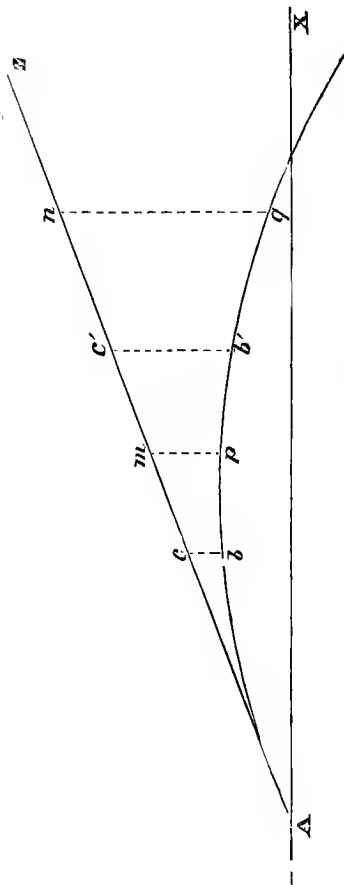
$$16.09 \times 4 = 64.36 \text{ feet;}$$

in three seconds,  $16.09 \times 9 = 144.81$  feet;

in four seconds,  $16.09 \times 16 = 257.44$  feet.

449. **Trajectory in a Vacuum.** We call the trajectory

Fig. 109.



the path that a projectile passes over when thrown in any direction whatever. We will first determine the trajectory without considering the effect of the resistance of the air; that is, upon the supposition that the ball moves in a vacuum.

Let the ball be projected from the point A (fig. 109), following a certain direction A Z, making with the horizontal plane an angle Z A X.

The straight line A Z, indicating the direction of the motion at the origin, is called *the line of fire*; this line is the continuation of the axis of the piece. The angle Z A X, which the line of fire makes with the horizontal plane, is called the *angle of fire*. The velocity of the projectile at

the origin is called the *initial* velocity. Suppose the initial velocity to be 100 feet per second. If the projectile were not acted upon by gravity, it would pass over the straight line A Z with a constant velocity of 100 feet per second; consequently, at the end of one second, it would have arrived at a point *c*, the distance A *c* being taken equal to 100 feet; but in consequence of gravity, it will have fallen in this time a vertical distance of 16.09 feet; hence, if we lay off, vertically below the point *c*, a distance *c b* equal to 16.09, the point *b* will be the point really occupied by the projectile at the end of one second. After two seconds, the projectile would have described, in virtue of its initial velocity, a distance A *c'* = 200 feet; but in consequence of gravity will have fallen vertically a distance of  $16.09 \times 4 = 64.36$  feet. Lay off vertically below the point *c'*, a distance *c' b'* = 64.36 feet, and we have the point *b'* as the point occupied by the projectile at the end of two seconds. In general, at the end of a certain time *t*, the distance passed over in the direction of the line of fire, by virtue of the initial velocity, would be  $t \times 100$  feet, and the height through which the projectile will have fallen vertically during the same time will be  $\frac{1}{2} g t^2$ .

We can, then, construct as many points of the trajectory as we wish. The construction would always be the same for any initial velocity whatever, *V*. The space passed over in the line of fire, by virtue of the initial velocity, and at the end of any time *t*, would be  $V t$ .

Upon the line of fire A Z, take two points *m* and *n*; the corresponding distances A *m* and A *n* are proportional to the times *t* and *t'* during which these distances

would have been passed over by virtue of the initial velocity. Thus

$$A m = V t, \quad A n = V t'.$$

$V$  being constant, we have

$$A m : A n :: t : t';$$

hence

$$A m^2 : A n^2 :: t^2 : t'^2.$$

The corresponding verticals  $m p$  and  $n q$ , which are the distances that the projectile has fallen below the line of fire at the end of the times  $t$  and  $t'$ , are proportional to the squares of these times; we have then

$$m p : n q :: t^2 : t'^2;$$

hence

$$m p : n q :: A m^2 : A n^2.$$

450. We thus see that, *the verticals let fall from the different points of the line of fire to meet the trajectory, are to one another, as the squares of the distances of these verticals from the origin.* ✱

This property suffices to characterize the trajectory completely, and shows it to be a curve, known under the name of *parabola*.

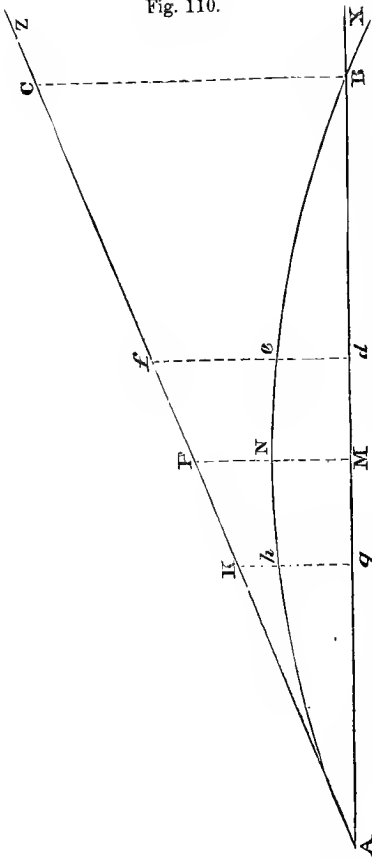
451. We proceed to demonstrate some of the leading properties of the trajectory in a vacuum.

The projectile always falls vertically below the line of fire; consequently, in theory, it remains always in the vertical plane passing through this line. *This vertical plane is called the plane of fire.*

The point B, fig. 110, where the trajectory cuts the horizontal A X, drawn from the point of origin, is the point of fall; the angle which the direction of the trajectory makes at this point with the horizontal is the angle of fall. The portion A B of the horizontal, con-

✱ Smith's mechanics art 266, p 162 for (62)  
 $v^2 = u^2 \cos^2 \alpha$  or  $v^2 \cos \alpha$

Fig. 110.



tained between the origin and the point of fall, is the horizontal range.

Upon any point  $g$  taken upon the horizontal, draw a vertical  $g K$  until it meets the line of fire; the triangles  $A g K$ ,  $A B C$ , being similar, we have  $g K : B C :: A g : A B$ ; hence

$$g K = \frac{B C \cdot A g}{A B};$$

again we have

$$K h : B C :: A K^2 : A c^2;$$

but

$$A K : A C :: A g : A B,$$

then

$$K h : B C :: A g^2 : A B^2;$$

hence

$$K h = \frac{B C \cdot A g^2}{A B^2}.$$

For the height  $g h$  at which the projectile passes above the point  $g$ , we have

$$g h = g K - K h;$$

substituting for  $g K$  and  $K h$  their values, we have

$$g h = \frac{B C \cdot A g}{A B} - \frac{B C \cdot A g^2}{A B^2} = \frac{B C \cdot A g}{A B^2} (A B - A g);$$

but

$$A B - A g = B g,$$

hence

$$g h = \frac{B C}{A B^2} A g \cdot B g.$$

The product  $A g \cdot B g$  is the measure of the rectangle constructed upon two lines whose sum is  $A B$ .

The perpendicular  $g h$ , erected at any point  $g$ , to meet the curve, is called an ordinate. From the value found for  $g h$ , we may conclude that: *any ordinate is equal to the vertical  $B C$ , multiplied by the product of the distances from the foot of the ordinate to the two extremities  $A$  and  $B$ , and divided by the square of the horizontal range  $A B$ .*

452. **Height of the Curve.** For the ordinate  $M N$ , erected upon the middle of  $A B$ , we have

$$M N = \frac{B C}{A B^2} A M \cdot B M = \frac{B C}{A B^2} A M^2. = h \sin^2 \alpha = 1.1 \text{ height}$$

We know that the greatest rectangle which we can construct upon two lines whose sum is given, is equal to the square made upon the half of this sum; we have then

$$A M \cdot B M \text{ or } A M^2 > A g \cdot B g;$$

and this will be the case whatever may be the position of the point  $g$  between the two points  $A$  and  $B$ . From which we conclude that: *the greatest ordinate which we can draw between  $A$  and  $B$ , is the ordinate erected upon the middle of  $A B$ . This ordinate, which is the greatest height attained by the projectile, is called the height of the trajectory.* Smith's *Mechanics* vol 271.

453. Take two points  $d$  and  $g$ , equally distant from the point  $M$ ; we have for the ordinates  $d e$  and  $g h$  erected at these points,

$$d e = \frac{B C}{A B^2} A d \cdot B d, \text{ and } g h = \frac{B C}{A B^2} A g \cdot B g.$$

Since the points  $d$  and  $g$  are equally distant from the middle point  $M$ , we have

$$A d = B g, \text{ and } A g = B d;$$

hence

$$A d. B d = A g. B g,$$

consequently  $d e = g h$ , that is to say, that: *the ordinates equally distant from the middle ordinate are equal.* We hence conclude that *the middle ordinate divides the curve into two equal parts.*

454. The portion of the curve contained between the origin  $A$  and the highest point  $N$ , is called the *ascending branch*; the portion contained between the point  $N$  and the point of fall, the *descending branch*. In a vacuum, these two branches are equal; consequently the angle of fall is equal to the angle of fire.

\* 455. The expression that we have already found for the middle ordinate gives the height of the curve, but we can find an expression for the height of the curve in terms of the horizontal range and the angle of fire. The vertical  $M P$ , erected on the middle of  $A B$ , to meet the line of fire, is equal to  $\frac{B C}{2}$ ;

on the other hand we have

$$P N = \frac{B C}{4};$$

now

$$M N = M P - P N = \frac{B C}{2} - \frac{B C}{4} = \frac{B C}{4}$$

In the right-angled triangle  $B A C$ , we have

$$B C = A B. \text{ tang. } A;$$

then

$$M N = \frac{1}{4} A B. \text{ tang. } A,$$

that is: in a vacuum, *the height of the curve is equal to a quarter of the horizontal range multiplied by the tangent of the angle of fire.* (Smith's Mechanics  $H = h \tan^2 a$  or  $R = 4h \csc a \sec a$ )

For an angle of fire of  $45^\circ$ ,  $\therefore h = \frac{R}{4}$

hence

$$\text{tang. } A = \frac{BC}{AB} = 1,$$

from which it follows that

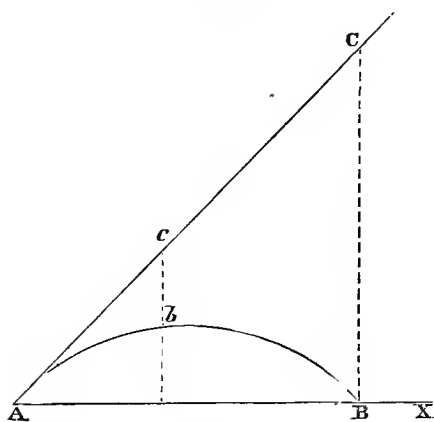
$$MN = \frac{1}{4} AB;$$

we conclude then that: *in a vacuum and for an angle of fire of  $45^\circ$ , the height of the curve is equal to a quarter of the horizontal range.*

456. **Range.** We proceed now to calculate the horizontal range, when we know the initial velocity and the angle of fire.

Suppose, first, an angle of  $45^\circ$ .

Fig. 111.



Upon the line of A Z, fig. 111, take a distance A c, equal to the initial velocity V; that is, that A c is just the distance that the projectile would pass over in the direction of the line A Z, during the first second of its motion,

if it were not acted upon by gravity. The corresponding vertical c b is the distance that the projectile will have fallen during the first second; consequently,

$$c b = \frac{1}{2} g;$$

and we have

$$c b : C B :: A c^2 : A C^2; \text{ or } \frac{1}{2} g : C B :: V^2 : A C^2.$$

The angle A being  $45^\circ$ , we have  $B C = A B$ ,  
consequently

$$A C^2 = A B^2 + B C^2 = 2 A B^2;$$

it follows then

$$\frac{1}{2} g : A B :: V^2 : 2 A B^2$$

$$2 A B^2 = \frac{A B \cdot V^2}{\frac{1}{2} g}$$

$$2 A B = \frac{2 V^2}{g}$$

$$A B = \frac{V^2}{g}; \quad \text{(S. d.) sh. art. 270 cor 1}$$

that is, that: *in a vacuum, and with an angle of fire of  $45^\circ$ , the horizontal range is equal to the square of the initial velocity divided by the constant number 32.18.*

457. Take any angle of fire, we have

$$B C = A B \cdot \text{tang. } A;$$

we have also

$$A C^2 = A B^2 + B C^2;$$

substituting for  $B C$  its value, we have

$$A C^2 = A B^2 + A B \cdot \text{tang.}^2 A$$

$$A C^2 = A B^2 (1 + \text{tang.}^2 A);$$

now substituting the values of  $B C$  and  $A C^2$  in the proportion

$$\frac{1}{2} g : C B :: V^2 : A C^2,$$

we have

$$\frac{1}{2} g : A B \cdot \text{tang. } A :: V^2 : A B^2 (1 + \text{tang.}^2 A).$$

from which

$$A B (1 + \text{tang.}^2 A) = \frac{2 V^2 \cdot \text{tang. } A}{g},$$

whence

$$A B = \frac{2 V^2 \text{tang. } A}{g (1 + \text{tang.}^2 A)};$$

now

$$\text{tang. } A = \frac{\sin. A}{\cos. A},$$

from which

$$\text{tang. } A \cdot \cos.^2 A = \sin. A \cdot \cos. A;$$

but

$$\cos.^2 A = \frac{1}{\sec.^2 A} = \frac{1}{1 + \text{tang.}^2 A};$$

hence

$$\frac{\text{tang. } A}{1 + \text{tang.}^2 A} = \sin. A \cdot \cos. A;$$

substituting this value in the equation

$$A B = \frac{2 V^2 \text{tang. } A}{g (1 + \text{tang.}^2 A)},$$

we have

$$A B = \frac{2 V^2 \sin. A \cdot \cos. A}{g};$$

but  $2 \sin. A \cdot \cos. A = \sin. 2 A$ ;

hence

$$A B = \frac{V^2}{g} \sin. 2 A, = 2h \sin 2a \text{ (50)}$$

that is, that: *in the vacuum, the horizontal range is equal to the square of the initial velocity multiplied by the sine of double the angle of fire, and divided by the constant number 32.18.*

458. If  $A = 45^\circ$ ,  $\sin. 2 A = 1$ . For any other value of  $A$  greater or less than  $45^\circ$ ,  $\sin. 2 A$  is less than 1. We hence conclude that: *in a vacuum, the angle of  $45^\circ$  is the angle of greatest range, that is, it is the angle*

which, with the same initial velocity, gives the greatest horizontal range. (S. de) and 270 cor 1

Suppose the angle of fire taken equally distant above and below  $45^\circ$ , the horizontal range will be the same in the two cases. In the last equation take

$$A = 45^\circ + a;$$

we have

$$\sin. 2 A = \sin. (90 + 2 a),$$

and, in taking

$$A = 45^\circ - a$$

we have

$$\sin. 2 A = \sin. (90 - 2 a);$$

now

$$\sin. (90 + 2 a) = \sin. (90 - 2 a);$$

thus, in a vacuum, for the same initial velocity, the angles of fire  $60^\circ$  and  $30^\circ$  would give the same horizontal range.  $\&$

From the expression

$$A B = \frac{V^2 \sin. 2 A}{g}$$

we conclude that: in a vacuum, and with the same angle of fire, the horizontal ranges are proportional to the squares of the initial velocities.

459. **Resistance of the Air.** When a body moves in the air, it encounters a resistance which is exerted in a direction contrary to its motion, and tends, consequently, to destroy its velocity.

This resistance depends upon the form and the extent of the surface upon which it is exerted, as well as upon the velocity of the moving body. In the case of spherical bodies, such as cannon balls, it is found, by experiment, that it is proportional to the surface, and that it increases more rapidly than the square of the velocity.

Relying upon the results of experiment to the present time, and making use of the empirical laws deduced therefrom, we find that a sphere of one inch radius, moving with the velocity of 1,000 feet per second, will experience a resistance from the air of 22.625 lbs. ; that is, that at the moment such a sphere moves through the air with a velocity of 1,000 feet per second, it will be retarded by the air to the same extent as if a force equivalent to 22.625 lbs. were urging it in an opposite direction.

We see that, through the effect of this retarding force, the velocity must diminish progressively in a continuous manner, and that the resistance itself, which depends upon the velocity, must diminish at the same time.

The following table gives the resistances corresponding to different velocities for a sphere of a radius of one inch :

Velocity per second.	Resistances corresponding.
Feet.	Lbs.
1,000	22.625
900	17.519
800	13.250
700	9.750
600	6.900
500	4.650
400	2.906
300	1.612
200	.709

The resistance being proportional to the surface, consequently to the square of the radius, it is easy to calculate the resistance encountered by a sphere of a given

radius, when we know that which is experienced by a sphere with a radius of one inch. Thus, for example, the 24-pounder ball has a radius of 2.84 inches, the resistance that the air will oppose to it, when moving at the rate of 1,000 feet per second, follows from the following proportion: .

$$1^2 : (2.84)^2 :: 22.625 : x = 182.484 \text{ lbs.}$$

the 12-pounder ball of 2.26 inches radius.

$$1^2 : (2.26)^2 :: 22.625 : x = 115.556 \text{ lbs.}$$

460. **Advantage of Large Calibre.** Since the retarding force which the air opposes to the motion of projectiles is proportional to their surface, it is greater for large balls than for small ones; but, on the other hand, the force which it is necessary to oppose to a projectile to destroy its velocity must be increased in proportion to its weight. Thus, for example, to stop a ball of twenty-four pounds moving with a certain velocity, we must oppose twice the force which would stop a ball of twelve pounds moving with the same velocity. It follows that the effect of the resistance of the air is in direct ratio to the surface of the projectiles, and in inverse ratio to their weights. Now the surfaces are proportional to the squares of the radii, whilst, in the case of solid shot, the weights are proportional to the cubes of the radii; it follows that, in the case of solid shot, the effect of the resistance of the air must be in inverse ratio of the radii. We see then that large balls have the advantage over smaller ones.

To appreciate, more fully, the advantage of the larger calibre, let us review the numerical results found above. The retarding force which acts upon the ball of 24 lbs., moving with a velocity of 1,000 feet per second, is 182-

.484 lbs. ; whilst it is but 115.556 lbs. for the ball of 12 lbs. moving with the same velocity. But the ball of 24 lbs. may be considered as formed by the union of two balls each of 12 lbs., either moiety of which is retarded in its motion by just one half of the whole 182.484 lbs., or 91.242 lbs. Thus 12 lbs. of metal experiences a retardation of 91.242 lbs. in the ball of 24 lbs., and of 115.556 lbs. in the ball of 12 lbs.

From what has preceded, it is easy to conclude that the effect of the resistance of the air must be less for solid shot than for hollow shot of the same diameter ; that this effect must also be less upon projectiles of lead than upon those of iron of the same calibre, because, in the same volume, lead weighs more than iron.

461. **Rotation.** In addition to the resistance of which we have just spoken, projectiles encounter another kind of resistance produced by the motion of rotation which is always imparted to them by the friction and shocks which they experience during their passage in the bore. This resistance, not being as the first, exerted exactly in a direction contrary to the motion of translation, produces lateral deviations, and must be considered as the principal cause of irregularities in fire.

462. **Deviations Not Due to Pointing.** When we compare the ordinary deviations of projectiles with the errors of pointing which would be necessary to produce them, we are soon convinced that these errors of pointing enter but little into the cause of irregularity of fire. What proves incontestably that lateral deviations do not depend only upon the direction given to the projectile at the commencement of its motion, is that they do not increase in proportion to the distance. From experiments

made with care we have seen that, in certain cases, they increase more rapidly than the distance; in other cases, after having reached a certain limit in one direction, they go on diminishing, and finish by deviating in an opposite direction.

Errors in pointing cannot be considered as responsible for all the vertical deviations that take place in the course of fire; these depend not only upon the motion of rotation, but also upon the difference in the initial velocities, and in the angle of departure resulting from the last shock in the bore.

As to the differences in initial velocities, they arise with the same powder and with the same piece, from more or less windage of the ball, and the fouling of the bore. Owing to this last cause, the first shots always present singular anomalies. When a piece has been washed, even when it is perfectly dry, the first shot falls short. After two or three fires the bore begins to grow foul, the range increases and the fire becomes more regular. When the piece has not been washed, and the deposit left in the gun has had time to absorb the moisture from the atmosphere, the range of the first fire is generally too long. We see from this that we should never be in a hurry to regulate the aim after the first fire.

**463. Trajectory in the Air.** From what has preceded we see that the trajectory in the air is not always situated in the plane of fire, since the projectile is influenced by deviating forces which push it successively to the right and to the left of this plane; but as it is impossible to foresee the direction and the velocity of the motion of rotation produced by the shocks, and the friction which

operate in the bore, we should ignore this motion of rotation, and consider only the resistance offered to the motion of translation, which is always exerted in a direction contrary to this motion.

It is evident that the effect of this resistance must be to diminish the range. To get an idea of this, compare some ranges calculated on the hypothesis of the vacuum, with those which actually take place in the air.

464. We have for the value of the range, in a vacuum, for a velocity of 1,640 feet per second, with an angle of fire of  $45^\circ$ ,

$$A B = \frac{V^2}{g} = \frac{(1,640)^2}{32.18} = 83,560 \text{ ft.} = 27,860 \text{ yards.}$$

now the greatest range of the 24-pounder ball, in air, with an initial velocity of 1,640 feet per second is 5,250 yards.

With low velocities and small angles of fire, the effects are far less. Thus, making  $V = 400$  feet,  $A = 8^\circ. 30'$ ,  $g = 32.18$ , we have

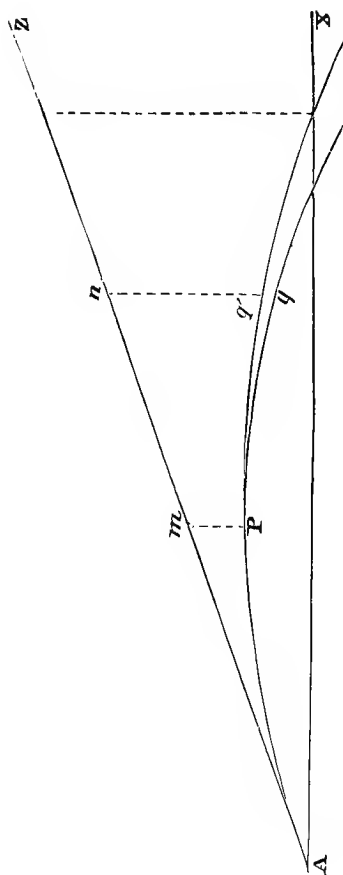
$$A B = \frac{V^2}{g} \sin. 2 A = \frac{(400)^2 \cdot \sin. 17^\circ}{32.18} = 1,454 \text{ ft.} = 485 \text{ yds.};$$

tables of fire, verified by careful practice, give 445 yards as the range of the 24-pounder ball fired with an initial velocity of 400 feet, at an angle of  $8^\circ. 30'$ .

465. We have seen that the trajectory in a vacuum is determined by this condition, viz.: *that the distances below the line of fire to which the projectile falls, are to one another as the squares of their distances from the origin, measured upon the line of fire.* To determine the trajectory in the air, we must know the law according to which the lengths of these verticals, let fall from the different points of the line of fire to meet the trajectory,

vary. The solution of this problem involves calculations long and difficult. All that we can see without calculation is that, in the air, these verticals must increase more rapidly than in a vacuum; now, in a vacuum, they increase as the squares of the distances measured upon the line of fire, consequently, in the air, they increase more rapidly than the squares of the distances measured upon this line.

Fig. 112.



466. **Range.** From the two points  $m$  and  $n$ , taken upon the line of fire  $AZ$  (fig. 112), let fall the verticals  $mP$  and  $nq'$ . If the motion took place in a vacuum we would have

$$nq' : mP :: A n^2 : A m^2;$$

hence

$$nq' = mP \frac{A n^2}{A m^2}$$

If, on leaving the point  $P$ , we suppose that the projectile, having always the same velocity and the same direction, should yield to the resistance of the air, it is evident that it can only meet the vertical drawn from the point  $n$  in a point  $q$ , lower than the point  $q'$ ; we have then

$$nq > mP \frac{A n^2}{A m^2}$$

For the same projectile, the difference is so much the greater as the initial velocity and the angle of fire are greater. For two different projectiles, fired at the same angle and with the same velocity; the difference is greater as the projectile is smaller, or as it is lighter for the same volume.

467. From the fact that the verticals increase more rapidly than the squares of the distances measured upon the line of fire, we can conclude that the trajectory in air must envelop completely, from the origin to the point of fall, the parabola which, with the same angle of fire, would give the same horizontal range; below the point, however, marking the horizontal range, the contrary is the case, that is, that below this point the trajectory in air passes below the trajectory in a vacuum.

468. **Height of the Curve.** We have seen that, in a vacuum, the height of the curve is equal to a quarter of the horizontal range multiplied by the tangent of the angle of fire; we can, then, conclude that in the air, to give the same horizontal range, the height of the curve must be greater than the quarter of the horizontal range multiplied by the tangent of the angle of fire. The smaller the projectile, the greater the difference. Thus, in military works, when mortars are fired at a given distance and with a fixed angle of fire, the shell of the 8-inch mortar must rise higher than that of the 10-inch, and that of the 10-inch higher than that of the 13-inch mortar.

We can also conclude that the greatest ordinate of the trajectory in air is nearer to the point of fall than to the origin; hence the ascending and descending branches of the trajectory are not equal in air; and the angle of fall is always greater than the angle of fire.

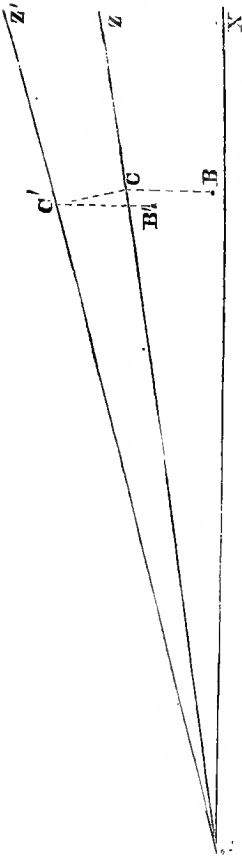
469. **Angle of Greatest Range.** In the air, the angle of greatest range is always less than  $45^\circ$ , and decreases in proportion to the increase of the initial velocity, for different pieces of ordnance varying from  $30^\circ$  to  $36^\circ$ .

When the angle of fire is very small, the direction of the motion is very nearly horizontal in every part of the trajectory which is situated above the horizontal plane, and in that which diverges only a little below that plane. Now, the resistance of the air is always exerted in a direction exactly contrary to the motion; consequently, the direction of this resistance is very nearly perpendicular to gravity which is always vertical; it follows, then, that this resistance cannot alter, in a sensible manner, the vertical velocity produced by gravity. We deduce from this the fundamental principle which serves as the base of the theory of pointing.

470. Suppose a projectile fired in a certain direction  $AZ$  (fig. 113), making a very small angle with the horizontal plane. If this projectile were free from the action of gravity, but affected by the resistance of the air, it would move without quitting the line  $AZ$ , and at the end of a certain time  $t$ , it would have passed over, on this line, a certain distance  $AC$ . But, by virtue of gravity, it must fall, during the time  $t$ , a certain distance  $CB$  below the line of fire.

Now suppose this same projectile to be fired with the same initial velocity, in a new direction  $AZ'$ , differing but little from the first direction. If we admit that the resistance of the air is felt only along the direction of the line of fire, the projectile will, by virtue of the initial velocity and of the resistance of the air, have passed over, during the time  $t$ , a distance  $AC' = AC$ ; but,

Fig. 113.



by virtue of gravity, it must have fallen, during the same time  $t$ , a distance  $C' B' = C B$ ; from which we conclude that: *with the same projectile and the same initial velocity, the distance that a projectile falls below the line of fire is always the same, whatever may be the angle of fire, provided always that this angle remains very small.*

Thus we can admit that the verticals  $C B$  and  $C' B'$  are equal, only because we suppose that the direction of the motion being nearly horizontal, the resistance of the air is only exerted along the line of fire, and has no effect whatever upon the motion produced by gravity.

It follows that this principle, *true in a vacuum for all angles of fire*, can be regarded as a sufficient approximation for practical purposes, only when the angles of fire do not exceed those which are usually employed in direct firing.

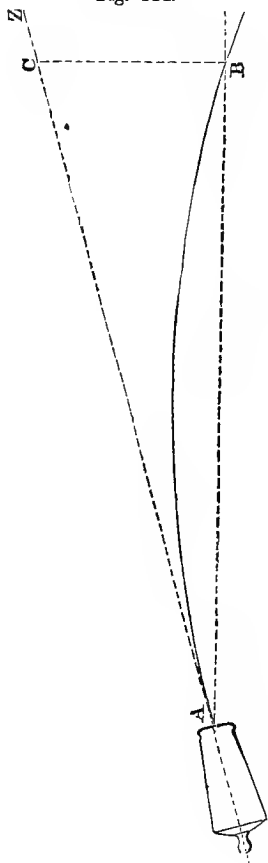
We may also consider this principle as a sufficient approximation when the angle of fire is moderately great, but the initial velocity quite small; because, in this case, the curve described in the air does not differ much from the parabola which would give the same horizontal range for the same angle of fire.

471. **Direct Fire.** The fire is said to be direct when

the projectile, fired under a certain angle, strikes, without grazing, an object which is uncovered and visible from the battery.

472. **Pointing.** We have already said that it was impossible to take into consideration the lateral deviations resulting from the motion of rotation; we must then ignore these deviations, and suppose that the projectile always falls vertically below the line of fire; consequently, to point a piece, it is necessary to direct it in such a

Fig. 114.



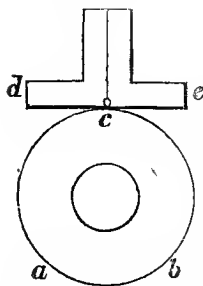
manner that the line of fire  $AZ$  (fig. 114), which is nothing more than the prolongation of the axis of the piece, shall pass vertically above the object  $B$ , a height  $BC$  equal to the distance that the projectile will fall below the line of fire while passing over the distance  $AB$ . The plane of fire is thus made to pass through the object. This is termed *lateral training*.

Cannon turn around their trunnions; the axis of the trunnions is perpendicular to the axis of the piece; consequently, when the axis of the trunnions is horizontal, the axis of the piece can only move in a vertical plane; this plane is, then, the plane of fire for all the inclinations of the piece. When the axis of the trunnions is not horizontal, there

will result errors in pointing, which we will consider further on; for the present we will consider this axis as perfectly horizontal. A plane drawn through the axis of the piece, perpendicular to the axis of the trunnions, cuts the swell of the muzzle and the base-ring in two points, which determines the sight notches. The straight line which passes through these sight notches is called the *line of metal sight* or the *natural line of sight*.

473. **Sight Notches.** The sight notches are determined by the founder; the trunnions being horizontal, a square and plumb bob,  $d e$  (fig. 115), is set on the base-ring or muzzle,  $a b c, d e$  being laid horizontal,

Fig. 115.



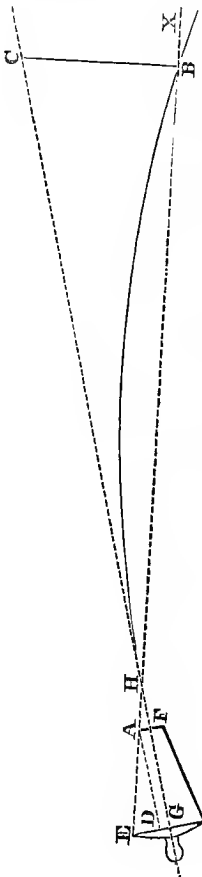
and being made tangent to the surface of the gun at the point where the plumb line marks the perpendicular; the plumb line will then be in a vertical plane passing through the axis and perpendicular to the axis of the trunnions. The sight notch is then marked at the point where the plumb line touches the surface of the gun.

This mark is made by the founder, but its correctness can be tested as follows; place the trunnion square in such a position that its legs, resting on skids supporting the gun at the base-ring shall set closely against the two sides of the base-ring; adjust the pointer of the trunnion square so that it shall touch the notch on the upper surface of the base-ring, and clamp it in this position. Now shift the trunnion square, end for end, so that the legs shall set closely to the opposite sides of the base-ring; if the pointer now touches the notch cut in the base-ring, the notch is in the required plane; if the pointer does not touch the notch, the

notch is not in this plane, and its error of position is equal to half the difference between it and the point touched on the base-ring at the second adjustment of the trunnion square.

474. **Point-Blank.** When the axis of the trunnions is horizontal, the axis of the piece and the natural line of sight are situated in the same vertical plane; consequently if we point a piece in such a manner that the

Fig. 116.



natural line of sight is directed at the object, we are certain that the vertical plane in which the axis of the piece moves, that is, the *plane of fire*, passes through the object; it remains then only to consider the inclination of the axis.

The radius E G (fig. 116) of the base ring being greater than the radius A F of the swell of the muzzle, the line of sight makes, with the axis of the piece, an angle E H G, which is called the *natural angle of sight*. This angle was formerly known as the *angle of dispart*.

The trajectory departs at first very little from the line of fire; consequently, it cuts the line of sight in a point H, where that line is intersected by the prolongation of the axis; departing farther from the line of fire, it cuts the line of sight in a second point B, which is called the *natural point-blank*; we have then this definition:

*The natural point-blank is the second*

*point of intersection of the trajectory with the natural line of sight.*

The distance of this point from the face of the muzzle is called the *point-blank range*. It is evident that, for the same piece, the point blank varies with the initial velocity, consequently with the charge of powder; and that with a fixed charge, it depends upon the quality of the powder, method of loading, windage, state of bore, &c. When we speak of the point-blank range of a cannon, without indicating the charge, we understand the highest service charge.

The first point of intersection H of the trajectory with the line of sight is called the *first point-blank*. A F is the radius at the swell of the muzzle; D E is the difference between this radius and that at the base-ring, called the *dispart*; D A, the interval between these two radii, is called the length of the piece. The natural angle of sight can be determined by the angle E A D, which is equal to E H G, thus

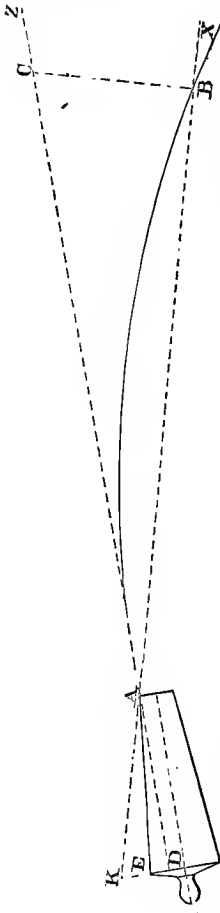
$$\text{tang. A} = \frac{DE}{AD}.$$

The consideration of the first point blank serves only uselessly to complicate the theory of pointing; we can easily omit it by supposing the axis of the piece to be raised in a direction parallel to itself, and passing over the sight notch on the muzzle in such a manner that the line of sight and the line of fire cut each other exactly at this point. This hypothesis, which greatly simplifies all questions relative to pointing, supposes that, at each point of the trajectory, the centre of the projectile is more elevated than it really is by a quantity equal to the radius of the greatest swell of the

muzzle; now, this radius is about a calibre; it is then an error about equal to the diameter of the projectile; such an error is entirely insignificant in practice. In all these cases it is easy to correct it by diminishing all the ordinates of the trajectory by a constant quantity equal to this radius.

475. **Tangent Scale.** When we wish to reach an object beyond the natural point-blank range, it is necessary

Fig. 117.



to increase the inclination of the piece; that is, to increase the angle made by the line of sight with the axis; in other words, to increase the angle of sight. This is done by increasing the radius of the base-ring by a quantity  $E K$  (fig. 117), varying according to the distance, and which is called *tangent scale* or *breech sight*. Represent this tangent scale  $E K$  by  $h$ .

The two similar triangles  $K A D$ ,  $A B C$  give

$$B C : D K :: A B : A D$$

$$\text{hence } B C = \frac{D K \cdot A B}{A D}.$$

The side  $D K$  is equal to  $(R - r) + h$ ; that is, the difference of the two radii increased by the length of the tangent scale. We represent this quantity by  $H$ , and call it the total *hausse* (from *hausser*, to increase); then

$$B C = \frac{H \cdot D}{l};$$

hence 
$$H = \frac{B C \cdot l}{D}.$$

The line of sight  $K B$ , determined by means of the hausse, is called an *artificial line of sight*; and the point  $B$  the *artificial point-blank*. We see, from this, that the application of the term point-blank is not limited, but that for every graduation on the breech sight we have a point blank, which is the second intersection of the trajectory with the lines of sight determined by means of the divisions on the breech sight, which are graduated to coincide with the distances of these point-blanks from the muzzle. The term is used frequently as synonymous with *range*, and is by some defined as such.

476. **Point-Blank.** The origin of the term *point-blank*, seems to have been derived from the *white point*, or bull's eye, at which the line of sight of the marksman was directed; and is also supposed to have some connection with the familiar order of "not to fire until you see the *whites* of the enemy's eyes;" but all uses of it point to an understanding that *when a piece was pointed at point-blank the line of sight was directed upon the object*. This understanding of the term agrees also with the use made of it in common parlance, it being used frequently adverbially to express *directly*\*. The definition given above, is the one adopted by the French; the English have another definition which will be given farther on in connection with front-sights; at present we will continue the subject of the tangent scale.

477. **Tangent Scale.** We have found that

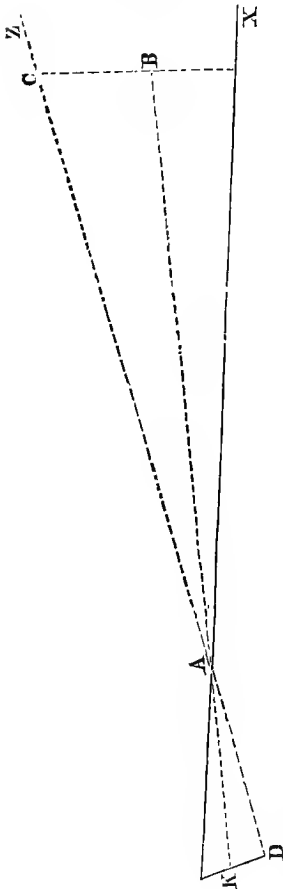
$$H : B C : l : D$$

expresses the relations that exist between these quan-

\* Worcester.

tities, the object having been supposed to be on the same level as the battery. It is desired to know if the proportion remains true if the object fired at be not on

Fig. 118.



the same level as the battery; in other words, it is desired to know whether the angle of sight depends solely upon the distance, and is altogether independent of the angle of elevation of the object.

Suppose that the object B is not on the same level with the battery, the line of sight A B (fig. 118), which is always directed toward the object, makes with the horizontal plane an angle B A X, which we call the angle of elevation of the object, and which is positive or negative according as the object is above or below the level of the battery. Represent this angle by  $\epsilon$ .

The axis of the piece passes a certain vertical distance B C above the object. The angle C A X is the angle of fire; represent it by P. The angle C A B, which the axis of the piece makes with the line of sight, is the angle of sight; this angle is equal to the angle of fire C A X diminished by the angle of elevation of the object B A X; we represent it by  $a$ .

C A X = P, the angle of fire,

C A B =  $\alpha$ , the angle of sight.

It may be remarked here that the angle of sight is equal to the angle of fire when the object is on the same level with the battery; for the angle of fire is the angle made by the line of fire (which is the axis produced) with the horizontal, and the angle of sight is the angle made by the line of fire with the line of sight, which is horizontal if the object be at the same level with the battery. In the present case they are unequal, and we have

$$\alpha = P - \epsilon.$$

In the triangle B C A, we have

$$B C : B A :: \sin. \alpha : \sin. B C A.$$

The angle B C A is the complement of the angle of fire P; consequently

$$\sin. B C A = \cos. P = \cos. (\alpha + \epsilon) = \cos. \alpha. \cos. \epsilon - \sin. \alpha. \sin. \epsilon$$

we have then

$$B C : B A :: \sin. \alpha : \cos. \alpha. \cos. \epsilon - \sin. \alpha. \sin. \epsilon.$$

In the right-angled triangle K A D, we have

$$\sin. \alpha = \frac{D K}{A K} \text{ and } \cos. \alpha = \frac{A D}{A K};$$

moreover D K = H, A D =  $l$ , A B = D.

Putting these values in the preceding proportion, we have

$$B C : D :: \frac{H}{A K} : \frac{l}{A K} \cos. \epsilon - \frac{H}{A K} \sin. \epsilon.$$

$$B C : D :: H : l. \cos. \epsilon - H. \sin. \epsilon$$

from which D H + B C. H. sin.  $\epsilon$  = B C.  $l. \cos. \epsilon$

$$H (D + B C. \sin. \epsilon) = B C. l. \cos. \epsilon$$

$$H = \frac{B C. l. \cos. \epsilon}{D + B C. \sin. \epsilon.}$$

The angle of sight remaining very small, we can admit, without appreciable error, that so long as the distance of the object  $A B = D$  remains the same, the distance  $A C$ , measured upon the line of fire, remains also the same; in this case the quantity  $B C$ , which the projectile falls below the line of fire, at the distance  $A C$ , does not vary. Now, the expression found for the value of  $H$  shows that, so long as  $D$  and  $B C$  do not vary ( $l$  being constant),  $H$  diminishes when the angle of elevation of the object,  $\epsilon$ , increases; for, as the angle increases, the cosine decreases while the sine increases; the value of  $H$ , then, will diminish; but, in the ordinary limits of direct fire, this diminution is so small that it can be neglected in practice. Turning to the figure we see, on the other hand, that when the angle  $\epsilon$  increases, the distance  $A C$  and consequently the height  $B C$  increase also; there results a slight increase of the hausse, sufficiently small to be neglected. These two errors, either of which taken separately may be neglected, are in a contrary direction and compensate one another.

We are able, then, to establish for practice this important principle; that, *in direct fire, the hausse depends only upon the distance, and remains invariable, whatever may be the angle of elevation of the object.*

Thus it appears that whether we fire upon an object upon the same level with the battery, or above or below it, the relation between the distance, length of piece, total hausse, and fall below the prolonged axis will be expressed by the proportion

$$H : B C :: l : D$$

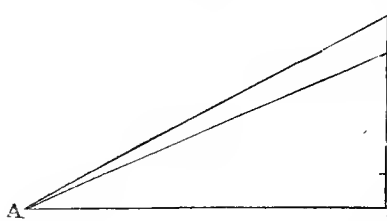
478. When the total hausse  $H$  is equal to the difference of the radii ( $R - r$ ), the distance  $D$  is the point-

blank range; now, from the foregoing, we see that this distance ought not to vary with the height of the object; from which we conclude that the point-blank range is always the same whatever may be the angle of elevation of the object; consequently in the definition of point blank, it is useless to introduce, as is sometimes done, this condition, viz.: *that the natural line of sight should be horizontal*, that is, that the object must be on a level with the muzzle of the piece.

479. **Vertical Deviations corresponding to Errors of Hausse.**

The proportion  $H : B C :: l : D$  gives the relation between the total hausse and the distance  $B C$  which the axis passes above the object. If an error exist in one of these quantities, a corresponding error will exist in the other. If instead of using the hausse  $H$ , fig. 119, corresponding

Fig. 119.



to the distance  $D$ , we use a different hausse  $H'$ , greater than  $H$ , the axis of the piece will pass above the object a distance  $B C'$ , differing from  $B C$ , and we

have  $H' : B C' :: l : D$ ,

from which

$$H' : B C' :: H : B C,$$

or

$$H' : H :: B C' : B C.$$

We draw from this

$$(H' - H) : H :: (B C' - B C) : B C,$$

or

$$(H' - H) : (B C' - B C) :: H : B C;$$

hence

$$(H' - H) : (B C' - B C) :: l : D.$$

Since  $H$  is the correct hausse corresponding to the distance  $D$ ,  $BC$  is the distance that the projectile falls below the axis, at that distance; it falls then below the point  $C'$  a distance equal to  $BC$ , consequently it passes above the object a distance equal to  $BC' - BC$ . If the hausse used,  $H'$ , were less than the correct hausse  $H$ , the projectile would pass below the object a distance equal to  $BC - BC'$ .

$H' - H$  is the error of hausse;  $BC' - BC$  is the corresponding vertical deviation; we have then between the error of hausse and the corresponding vertical deviation this relation; that *the error of hausse is to the corresponding vertical deviation as the length of the piece is to the distance from the object.*

The following table shows the vertical deviations, at the several distances indicated, for an error of hausse of .1 inch.

NAVY GUNS.	100 yds. feet.	200 yds. feet.	500 yds. feet.	1,000 yds. feet.
32-pdr.	27	.54	1.35	2.70
42 "	.264	.528	1.32	2.64

Thus if, in practice with the 32-pounder at 1,000 yds., we should put up the breech sight too high by .1 inch, the ball would pass 2.7 feet above the object.

480. **Negative Hausse.** In order to strike an object placed at a distance less than point-blank range, it will be necessary to diminish the angle that the axis of the piece makes with the natural line of sight. This must be accomplished by diminishing the difference between the radii of the muzzle and base-ring. This amount, which it will be necessary to take from the radius of the base-ring, is called *negative hausse*. Represent it by  $h$ .

The total hausse  $H$  is then equal to  $(R - r) - h$ . If,



To do this, we commence by aiming at natural point-blank upon the object B (fig. 120); we take a positive hausse D E, equal to the negative hausse that it would be necessary to use corresponding to the distance; sight along this hausse and the sight notch on the muzzle; this line of sight will meet the ground at a certain point G, which note carefully, and then direct the natural line of sight on this point.

It is evident that the relation between the hausse and vertical fall is preserved by pointing in this manner, for continuing the line A G to B' vertically below B, and joining B and B', we have

$$B B' : E D :: A B : A D.$$

or

$$B B' : h :: D : l.$$

481. **Dispart Sight.** The practical difficulty attending the determining of the point to aim at, especially on board ship, has led to the adoption of a line of sight parallel to the axis. This line is produced by placing on the gun a front sight equal to the dispart. The old front sight was simply a piece of plank, having its lower edge fitted to the chase of the gun; another form was to place a button on the highest point of the muzzle raised to the level of the base-ring.

482. A more elaborate arrangement of front sight was suggested by M. Roche, professor at the school of the French marine artillery. His front sight was composed of two uprights which were graduated, and between which moved a horizontal plate; by changing the height of this plate he changed the angle of sight. In order to render his system applicable to all distances, he placed upon the breech a fixed hausse corresponding to the greatest distance at which we are accustomed to fire

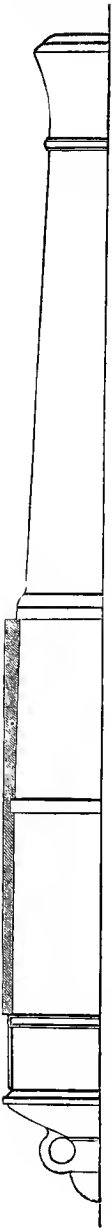
at sea, that is to say, from 1,100 to 1,300 yards. He raised the uprights of his front sight to a level with this hausse. When the movable plate was at the most elevated point, the line of sight was parallel to the axis. As the movable plate was lowered, the angle of sight increased until the line of sight became tangent to the muzzle.

483. In the use of broadside guns, it was found very objectionable to place the front sight on the muzzle, in consequence of their liability to be knocked off or broken by the port; they are now placed on the second reinforce. The height for the front sight is determined by means of a brass tompion which fits in the muzzle of the gun, and has an arm which is laid vertically, by levelling an offset of the tompion, which is fitted at right angles with the arm; the length of the arm is equal to the radius of the base-ring plus the height of the notch, in the breech sight when at level. From the end of this arm a thread is stretched to the breech sight, which thread lies in the vertical plane passing through the axis of the bore, and is parallel to the axis. The height of this thread above the surface of the gun determines the height of the front sight.

484. The line of sight, determined by means of the front sight, is called a *dispart sight*, and was formerly expressed upon the gun as shown in fig. 121, the sight being made of wood strapped to the gun. The visual ray was directed through a tubular opening bored longitudinally; the upper portion of this tube was subsequently removed, leaving a groove on the top of the sight along which the aim was taken.

485. **Point-Blank.** Cannon fitted with dispart sights

Fig 121.



had, of course, no natural angle of sight, consequently no *natural point-blank*; hence the *range at level* began to be designated as *point-blank*, and this is the definition of the term adopted by the English, and generally received in the United States service as the signification of the term. The English define the point-blank range as the distance from the muzzle of the gun to the intersection of the trajectory with the horizontal plane on which the trucks of the carriage rest, the axis of the piece being laid horizontally; in the U. S. naval service it is understood as signifying the distance from the muzzle of the gun to the intersection of the trajectory with the surface of the water, the gun being raised a certain distance above this surface, always supposing the axis of the piece to be laid horizontally.

This understanding of the term limits its application to one point, (which would be better defined as the *range at level*) and tends to prevent any clear and definite idea of the true meaning of the term from being fixed on the mind; it would seem to be very desirable to abandon this definition altogether, and to accept the term as signifying all aims that are taken *directly* upon an object, no matter what may be the angle of sight on which depends the value of the *point-blank*. To aim at point-blank upon an object would, thus, simply imply that the line of sight

was to be directed upon it, the angle of sight giving such a direction to this line as to make the intersection of the trajectory with the line of sight occur at the object. In all cases of *direct fire*, then, the aim would be taken at *point-blank*; whereas, in cases of *rolling fire* or *ricochet*, the aim would not be taken at point-blank upon the object, but upon some intermediate point.

486. **Sights on U. S. Navy Cannon.** Navy cannon are supplied with two sights, a breech sight, and a front sight on the second reinforce. When the mark *level* on the sight bar coincides with the upper surface of the sight box, a line drawn from the bottom of the notch to the top of the front sight is parallel to the axis of the bore, and thus supplies a dispart sight, with which we can aim at all points within the range at level of the piece. It is however, in strictness, committing an error, ever to aim with the dispart sight, except when the object is very near to the muzzle; to make this apparent, we will illustrate with a particular gun.

487. **Use of Graduations between "Level" and Range at Level.** The range at level of the 32-pounder of 33 cwt. is 288 yards, and this is the first graduation on the breech sight of which the value is expressed; that is, suppose the gun to be laid level (breech sight down to "level") and the line of sight to be directed at the side of a ship 288 yards distant on a point at the same height from the water as is the eye of the captain of the gun; if the gun be fired, the shot, falling by virtue of gravity from the moment it leaves the muzzle, will strike the side at the water-line. Now it is evident that the eye of the captain of the gun cannot see the water-line, hence he has struck a point that he did not aim at. Now, supposing

the axis of the piece in the same position as before, if he raise the breech sight until the graduation for 288 yards coincide with the upper surface of the sight box, he will find that the visual ray intersects the side of the ship at the water-line. This, then, should have been the position of the sight bar when he aimed at an object at the distance of the range at level, in order that he might have aimed at the point that he wished and expected to hit.

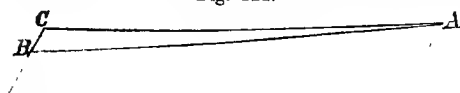
Suppose the ship at the distance of 144 yards; if the line of sight be taken at level, the ball will strike the side at a point about a quarter the distance between the level of the eye of the captain of the gun and the water, and if the breech sight be raised until the top of the sight box coincides with the graduation placed about a quarter of the distance between level and 288, the visual ray will be found to pass through the point struck. From this it is evident that, for all distances whether greater or less than the range at level, use should be made of the graduated breech sight, and that a positive error is committed by ever pointing at *level*, without the object is *close aboard*.

The necessity of this precaution becomes particularly apparent when we consider the object to be fired at as having but little magnitude, a boat for instance; we see that, as the ball commences to fall, in obedience to gravity, from the moment it leaves the muzzle, we can never count on hitting the object *direct* (except from the influence of deviating causes), but that the ball will always fall short of the object, and the effect will have to be trusted to the chance of a lucky ricochet.

488. **Marking Breech-Sights.** The breech sights of the

U. S. Navy cannon are secured at a fixed angle with the axis of the bore. The determination, then, of the graduation for degrees involves the solution of a triangle of which one side and the three angles are known. Thus,

Fig. 122.



in fig. 122, A is the position of the front sight; A B is the distance from

the front sight to the rear face of the breech sight bar; this line being parallel to the axis of the bore, the angle B is  $60^\circ$ ; the problem is, to determine the length of the side B C for all the values given to the angle A.

Take, for example, the 32-pounder of 33 cwt.; the length of the side A B is 2 feet 7 inches = 31 inches.

$$\begin{aligned} \text{Suppose angle } A &= 1^\circ \\ \text{then } C &= 119^\circ \\ \text{constant } B &= 60^\circ \end{aligned}$$

we have

$$\begin{aligned} \sin. C : \sin. A :: A B : B C \\ B C = \frac{A B. \sin. A}{\sin. C} = A B. \sin. A. \operatorname{cosec}. C \end{aligned}$$

$$B C = 31 \text{ inch.} \times \sin. 1^\circ \times \operatorname{cosec}. 119^\circ.$$

$$1.49136$$

$$8.24186$$

$$.06247$$

$$B C = \underline{\underline{9.79569}} = .6247 \text{ of an inch.}$$

$$\text{Suppose } A = 2^\circ$$

$$B = 60^\circ$$

$$C = 118^\circ$$

$$B C = A B. \sin. A. \operatorname{cosec}. C$$

1.49136

8.54282

.05818

$$B C = \underline{\underline{10.09236}} = 1.237 \text{ of an inch.}$$

In like manner, taking  $A = 3^\circ$ , we find  $B C = 1.8373$  of an inch, so that we see that it will be sufficiently accurate, after having determined the value of  $B C$  for one degree, to multiply it by two, three, and four, in order to determine  $B C$  for these different values of  $A$ .

489. It is evident that, for the same value of  $A$ , the length of the side  $B C$  will increase with the length of the side  $A B$ ; hence, when firing at great angles with pivot guns, it may become necessary to shift the front sight from the reinforce to the muzzle, the breech sight must be replaced by another, graduated in proportion to the increased length of the side  $A B$ .

490. The mode of marking breech sights at present adopted in the U. S. Navy, for practical convenience in pointing, is to mark lines on the sight bar, denoting angles of elevation, and to express, on them the corresponding ranges in yards. These ranges are determined by firing the gun at the different elevations, and noting the ranges with plane tables. The angles given by the plane tables are plotted on a projection of a convenient scale, and the distance of the graze from the gun is measured on the projection.

491. **Relation between Total Haussé and Time of Flight.** We have already seen, in direct firing, that, when the trajectory does not depart much from the horizontal, the resistance of the air remains always nearly perpendicular

to the direction of gravity; consequently the vertical velocity of fall is not sensibly altered. Represent by  $t$  the time that a projectile takes to fall a distance B C below the line of fire, we have

$$B C = \frac{1}{2} g t^2;$$

but

$$B C = \frac{H. D}{l};$$

hence

$$\frac{1}{2} g t^2 = \frac{H. D}{l}$$

$$t^2 = \frac{2 H. D}{g l}$$

$$t = \sqrt{\frac{2 H. D}{g l}};$$

thus, for a 12-pounder at 984 yards we have

H = .076 yds., D = 984 yds.,  $l = 2.2713$  yds., and  $g = 10.723$  yards;

hence

$$t = \sqrt{\frac{2 \times .076 \times 984}{2.2713 \times 10.723}} = 2''.478.$$

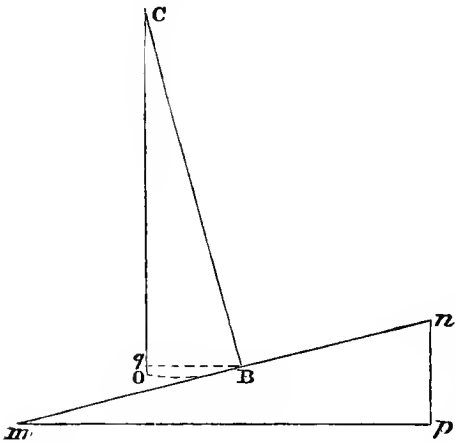
We can verify the degree of exactness of this formula by means of a chronometer; but as we have not one always at our disposal, a means of verification can be used founded upon the velocity of sound in the air.

This velocity varies with the temperature; nevertheless we may take 1,116 feet per second as a mean; consequently an observer, placed at a distance from the piece equal to 1,116 feet multiplied by the time (in the case cited, 2''.478), should hear the sound of the explosion at the same instant that he sees the ball strike an object placed at 984 yards from the piece.

492. **Deviations Resulting from a Difference of Level in the Trucks.** When the axis of the trunnions is horizontal, the line of sight and the axis of the piece are in the same vertical plane; consequently there will be no cause of deviation, depending upon the pointing, except that which may result from the line of sight not being directed with sufficient precision upon the object. Now, the alignment of three points is so simple an operation that no error should result from want of exactness in this particular. Deviations, then, lateral and vertical, when the trucks are on a level, must be attributed to causes independent of pointing. The principal cause is the motion of rotation of the projectile.

It is far different when the axis of the trunnions is not horizontal. In this case, the line of sight and the line of fire are not in the same vertical plane; there results from this a cause of lateral and vertical deviation depending upon the pointing.

Fig. 123.



Through the object B (fig. 123), draw a straight line  $m n$  parallel to the axis of the trunnions; take upon this line a distance  $m n$  equal to the width between the trucks. Through the lowest point  $m$ , draw a horizontal, and from the highest point  $n$  let fall a vertical to meet the horizontal line

at  $p$ . This line  $n p$  is the difference of level of the two trucks.

The line of sight and the axis of the piece determine a plane which is always perpendicular to the axis of the trunnions; consequently, this plane cuts the vertical plane passing through  $m n$ , in the direction  $B C$  perpendicular to the line  $m n$ .

The axis of the piece ought to meet this same vertical plane in a certain point  $C$ , situated upon this same perpendicular. We have found before, for the expression of the length  $B C$

$$B C = \frac{H. D}{l}.$$

This quantity is the distance that the projectile falls vertically below the point  $C$ ; consequently, if we let fall from the point  $C$  the vertical  $C O$  equal to  $B C$ , the the point  $O$  will be the point struck by the projectile. Drawing through the point  $B$  a horizontal to meet this vertical in  $q$ , the line  $B q$  will be the horizontal deviation, and the line  $q O$  the vertical deviation.

The point  $C$  being always situated above the point  $B$ , we see that the deviation always takes place on the side of the lower truck.

The two triangles  $m n p$ ,  $C B q$  are similar, as having their sides perpendicular. We have then

$$B q : n p :: B C : m n ;$$

hence

$$B q = \frac{B C. n p}{m n},$$

$n p$  is the difference of level of the trucks; represent it by  $d$ .

$m n$  is the width between the trucks; represent it by  $W$ .

Now substituting for B C its value  $\frac{H. D}{l}$ , we have

$$B q = \frac{H. D. d}{W. l}.$$

The vertical deviation  $q O$  is equal to

$$B C - C q = B C - \sqrt{B C^2 - B q^2};$$

substituting for B C and B q their values, we have

$$q O = \frac{H. D}{l} - \sqrt{\frac{H^2. D^2}{l^2} - \frac{H^2. D^2. d^2}{W^2. l^2}}$$

$$q O = \frac{H. D}{l} - \sqrt{\frac{H^2. D^2. W^2}{W^2. l^2} - \frac{H^2. D^2. d^2}{W^2. l^2}}$$

$$q O = \frac{H. D}{l} - \frac{H. D}{W. l} \sqrt{W^2 - d^2}$$

$$q O = \frac{H. D. W}{W. l} - \frac{H. D}{W. l} \sqrt{W^2 - d^2}$$

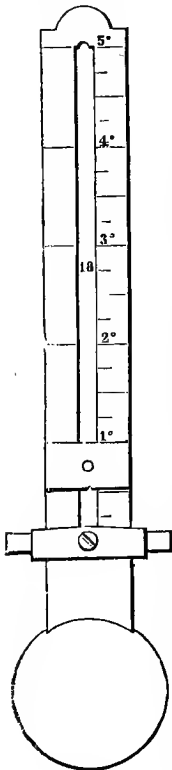
$$q O = \frac{H. D}{W. l} (W - \sqrt{W^2 - d^2}).$$

493. It is evident that, for the same difference of level, the deviation is proportional to the distance of the object.

494. This cause of deviation is one that obtains on ship-board more than elsewhere, for the motion of the vessel renders it very uncertain that the axis of the trunnions will be horizontal at the moment that the gun is fired. The guns forward and aft are particularly subjected to the disadvantage arising from this cause, and experience may be made to show that, as a general rule, the best firing done from a ship is that done by her divisions which are quartered in the waist, for these guns are not, like those forward and abaft of them, affected by the *sheer* of the ship.

495. In *chase firing*, this deviation becomes a matter of great importance. Chases being necessarily made under a press of sail, the pursuing and pursued have generally a considerable heel (if sailing on a wind); in consequence of this the guns in the bow and stern ports of each are inclined to leeward; the result will be that the shot will fall, or be apparently deflected to leeward of the object pointed at. The effect of this error may be avoided when chasing, or being chased, by the simple practice of taking care to point the bow or stern guns, as the case may be, at the weathermost part of the hull, the sights being, of course, adjusted to the distance in the usual manner.

Fig. 124.



496. Some efforts have been made to overcome the effects produced by this cause, which can be described generally as follows: instead of the sight bar being secured in a box, preserving it in a plane perpendicular to the axis of the trunnions, it is *pivoted* in such a manner as to be placed, or to place itself, in a *vertical* position at all times. The line of sight is drawn through this sight tangent to the most-elevated point of the muzzle.

Fig. 124 represents a *pendulum hausse* in use in the United States Army for light field pieces; it consists of an upright piece of sheet brass, and has a movable slider and scale. At the lower end is placed a bulb or disk, filled with lead. The scale passes through a slit in a piece of steel, and is connected with it by a brass

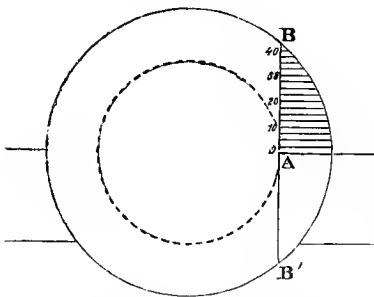
screw, which serves as a point on which the scale vibrates laterally; the slit is made long enough to allow the scale to assume a vertical position in any ordinary cases of irregularity of the ground on which the gun carriage may stand. The ends of the piece of steel are formed into journals or trunnions, by means of which the hausse is supported on the seat attached to the base of the breech, and is at liberty to vibrate in the direction of the axis of the piece.

Thus in any ordinary variations, either in the level of the wheels or in the elevation of the gun, the scale is kept in the vertical position by the weight of the bulb at the bottom.

497. **Description of some Old Systems of Pointing. Side Pointing.** Tixier de Norbec speaks of a manner of pointing by making use of a side line of sight. Since that time different systems of pointing, founded upon the same principle, have been proposed. All these systems may be summed up as follows :

The axis of the piece and the axis of the trunnions being placed horizontally, imagine a horizontal plane tangent to the upper part of the trunnions (when side

Fig. 125.



pointing was in use, guns were quarter hung); this plane cuts the greatest circumference of the muzzle in two points; at one of these points, the one on the right A (fig. 125), place a sight button; through this point A

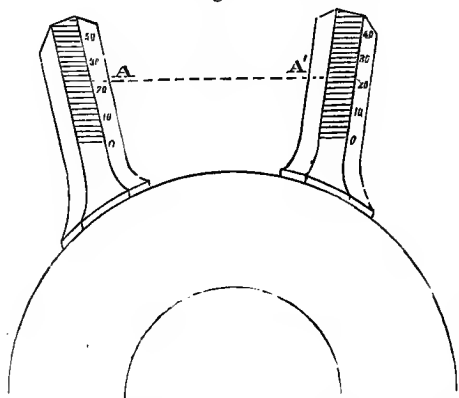
draw a vertical plane parallel to the axis of the piece.

This plane cuts the base ring in two points  $B B'$ , which we suppose joined by a straight line. Trace the intersection of this plane upon the base of the breech. The point of intersection of the straight line  $B B'$  with the plane tangent to the upper part of the trunnions is marked zero. From this point we graduate toward  $B$  on the line  $B B'$ , and through each of these divisions we draw a horizontal plane, marking its intersection on the base of the breech.

In order to point, we commence by directing the piece in such a manner that the sight button of the muzzle shall be situated in the vertical plane passing through the line  $B B'$  and through the object; then we give the elevation by lowering the breech until the sight button lies in the plane determined by the object and by the horizontal mark on the base of the breech corresponding to the elevation that we wish to give to the piece.

498. **Pointing by Means of the Handles.** This means of

Fig. 126.



pointing consists in a thread  $A A'$  (fig. 126) extended between the handles parallel to the axis of the trunnions. The eye being maintained in the plane determined by this thread and the object, if we drop the

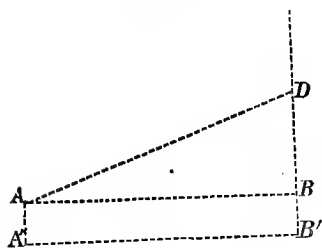
breech until the thread appears tangent to the upper part of the muzzle, we have a positive hausse; if, on the contrary, we raise the breech until the thread ap-

pears tangent to the base-ring, we have a negative hausse.

In order to fix the thread at different heights, divisions, one-twentieth of an inch in depth, are cut on the rear side of the two handles. Two small buttons are fixed upon the outer sides. The thread, attached by a loop to one of these buttons, passes across the division on the handle corresponding to the hausse that we wish to use, and two or three turns are taken around the opposite button.

499. **Tangent-Firing.** Before the introduction of the tangent scale or breech sight, all pointing at sea was done with the dispart sight; thus, when desiring to strike an object beyond the *range at level* of the piece, the trajectory being always below the line of sight, it was impossible to determine a point-blank corresponding to the distance of the object. It became necessary, then, to direct the line of sight (which was parallel to the axis of the piece) at a point a certain distance above the object, this elevation being intended to allow for the space through which the projectile falls by the action of gravity in the time of flight. Now the vertical space through which the projected body, in its flight,

Fig. 127.



descends below the line of fire, is equal to the tangent of the angle of elevation multiplied by the range or horizontal distance of the object from the gun; in fig. 127,

$$\text{tang. } A = \frac{BD}{AB},$$

$$BD = AB \cdot \text{tang. } A.$$

Thus suppose a gun to be at A, at a known height A A' above the level of the water, and at a known distance A B from a vertical object B'C, as a ship's mast. For any particular nature of ordnance we know the elevation necessary to project the projectile a certain distance. Now in the equation

$$B D = A B. \text{ tang. } A$$

A B, equal to the distance, is known, as is also the angle A, which is the angle of elevation necessary to give the gun in order to project the ball the distance A B. But we have no means of laying the gun at this angle, except by finding the length of the vertical which will subtend this vertical angle at the distance of the object. The required length of vertical B D, is found by the equation

$$B D = A B. \text{ tang. } A;$$

if then the line of sight, parallel to the axis be directed at the point D, we know that the gun has the elevation that is required in order to make the ball reach to the distance A B. Adding to both sides B B', we have

$$B' D = A B, \text{ tang. } A + B B'.$$

To strike an object, then, at the water line, at the distance A B greater than the range at level, the aim being taken with the dispart sight, it is necessary to direct the line of sight at a point situated at the distance B'D above the water line.

The heights of certain points on the masts of foreign men-of-war being known, tables have been constructed, in the columns of which are designated the points at which the line of sight must be directed corresponding to certain distances of the object which it is desired to hit. In the Ordnance Instructions tables of this char-

acter will be found, calculated with reference to British and French ships of war of four different classes.

This mode of firing presents serious disadvantages, and is calculated to increase deviations depending upon errors in pointing; especially is this apparent in the effect that it would have upon deviations if the ships were, as in "chase firing," much careened, when the shot would not only be inclined to leeward on account of the difference of level of the trucks of your own gun, but the enemy's mast being also inclined to leeward the gun would be pointed to leeward, and evidently the error would be the greater the higher the aim is taken.

Although this system of firing should never be adopted except under necessity, it is very necessary that the principle of tangent firing should be understood, in order that a gun may not be considered as disabled if an accident should destroy the breech sight.

500. **Ricochet Firing.** By this term, when used afloat, is meant the causing shot to graze on the water short of the object, so that it may be reached by successive bounds or ricochets.

A gun fired from a lower deck, when laid level\*, will generally make more than eighteen ricochets before its extreme range is completed. This is a very proper mode to fire shot at a cluster of row boats &c., and even small craft of a *slight scantling*; but when so doing, two circumstances should be kept in mind—1st. That causes, seemingly of little moment, will produce considerable deflection from the line of direction, for instance, shot grazing on a rough sea or on very shoal

\* On ship-board, a gun is supposed to be laid level when the line of sight, parallel to the axis, is directed at the horizon.

water, so that they may touch the ground; or even by the shot ricocheting on a current crossing the direction of the range. 2d. The power of the shot as to penetration, after having made a certain number of grazes on the water; for as a shot evidently loses some force by every graze, it is desirable to know after how many, and under what circumstances of weight, elevation, and charge, it will retain sufficient force to penetrate. Ricochet firing should not be practiced over water at angles exceeding  $4^{\circ}$  or  $5^{\circ}$ . This system of firing should be, more properly, called rolling fire.

Ricochet firing, *properly so called*, is employed in order to reach objects placed behind a covering mass, such as a parapet or a traverse. The projectile can produce its effect either by the first shock, or by rolling and bounding the length of the terreplein; hence the name of ricochet firing.

When a face of a work is exposed to this kind of fire, it is understood that its defences must be promptly ruined; hence it has been the effort to guard against this kind of fire, as much as possible, by means of *traverses*, the object of which is to render the ricochet, or bounds of the shot, impossible. The angle of ten degrees is regarded as the utmost limit of the angles favorable for ricochet firing; now, when a projectile grazes the crest of a parapet elevated two and a half yards, making an angle of  $10^{\circ}$  with the horizontal plane, it will strike the terreplein at fourteen yards from the foot of the parapet; consequently, if the traverses be placed at distances of about fourteen yards apart, the shot will bury itself in the ground at the foot of a traverse. Traverses are consequently placed at in-

tervals of about fourteen yards; and against a face provided with traverses we can only count upon the effect of the first shock. The problem proposed, then, in ricochet firing, is: *to make the projectile pass through a fixed point behind the covering mass.*

To do this, it is necessary that the projectile graze the interior crest of the parapet, which we call the object or the point of arrival, making with the horizontal plane an angle which we call the *angle of arrival*, and the size of which depends upon the position of the objects which we wish to hit behind the covering mass.

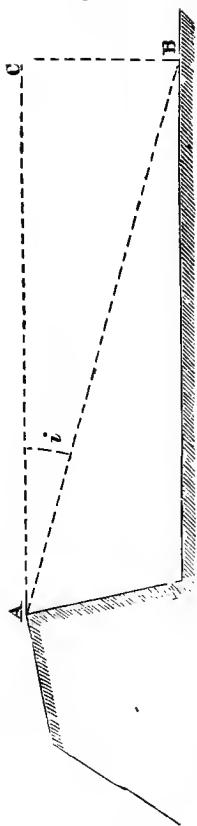
The difference between *direct firing* and *ricochet firing* consists then in this: in direct firing, the initial velocity remains constant; we propose only to make the projectile reach the object, no matter under what angle. In ricochet firing, the initial velocity and the angle of fire are variable; we wish not only to make the projectile reach the object, but we wish to make it reach it under a determined angle. In direct firing, we impose on ourselves a single condition; in ricochet firing, we impose on ourselves two conditions.

501. The first problem which presents itself is to determine the *angle of arrival*, knowing the horizontal and vertical distances between the interior crest of the parapet and the point that we wish to hit.

**Angle of Arrival.** Let A (fig. 128) be the interior crest of a parapet, B the point that we wish to hit. Let us consider as a straight line the small arc of the trajectory comprised between the point A and the point B; the angle C A B will be the angle of arrival; represent it by  $\epsilon$ .

Call  $\alpha$  the vertical distance C B from the point B to

Fig. 128.



the crest, and  $b$  the horizontal distance  $A C$ ; the right-angled triangle  $C A B$  gives us

$$\text{tang } i = \frac{a}{b}.$$

Nothing is easier than to calculate the angle  $i$  by means of the tables of tangents; but the employment of tables, however simple they may be, is impracticable in the field; it is necessary then to seek some practical solution which does not require the employment of any table.

Supposing the angles proportional to their tangents, which gives an approximation more than sufficient for the question under consideration, we have these two very simple relations:

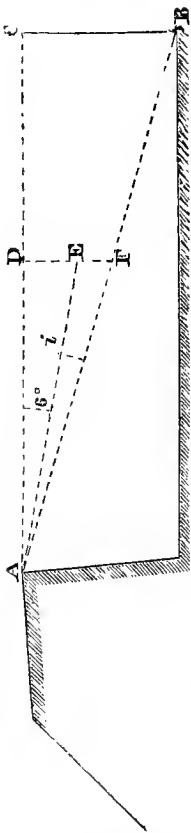
1st. *At the same distance from the crest, the fall of the projectile is proportional to the angle of arrival.*

2d. *For the same angle of arrival, the fall of the projectile is proportional to the distance from the crest.*

If now we remark that the tangent of the angle of  $6^\circ$  is 0.1051, that, consequently, for the angle of  $6^\circ$  and at the distance of 1 yard, the fall of the projectile is very nearly one-tenth of a yard, it is easy to find a very simple formula in order to calculate approximately the angles of arrival.

Call  $a'$  the distance  $D F$  (fig. 129) which the projectile falls below the crest at the distance  $A D = 1$  yard,

Fig. 129.



and for the angle of arrival  $C A B = i$ . The distance  $D E$  which it falls at the same distance of 1 yard for the angle of arrival of  $6^\circ$  is 0.1 yd.; taking the tangents proportional to the angles we have, according to the first relation established above,

$$a' : 0.1 :: i : 6^\circ.$$

The two similar triangles  $D A F$  and  $C A B$  give

$$C B : D F :: A C : A D,$$

or

$$a : a' :: b : 1,$$

which expresses the 2d relation established above.

Multiplying this proportion, term by term, with the first, it becomes

$$a a' : a' \times 0.1 :: b \times i : 6^\circ$$

or

$$a : 0.1 :: b \times i : 6^\circ$$

$$6^\circ \times a = (0.1 \times b) i$$

$$i = 60^\circ \frac{a}{b}.$$

That is, that *in order to have the angle of arrival, it is necessary to multiply sixty degrees by the vertical distance to the crest from the point which we wish to hit, and to divide by the horizontal distance.*

This angle being known, becomes one of the given quantities in the problem for the determination of the angle of fire and of the charge.

The other given parts of the problem are the distance and the angle of elevation of the object.

The distance is always known; as to the angle of elevation of the object, we can measure it directly from the battery. In order to do this, it is sufficient to direct a straight-edge toward the parapet to be leaped over, and to place the gunner's quadrant upon this straight-edge in order to measure its inclination.

502. **The Angle of Fire.** In ricochet firing, the distance of the object is never very great, since, unless in exceptional cases, it never exceeds or even amounts to 550 or 650 yards. The angle of fire is always considerable; consequently, the initial velocity is quite small; in fine, we only employ projectiles of a large calibre, which suffer the least from the resistance of the air. All these circumstances go to show that the trajectory, in this kind of fire, does not differ much from the parabola. We can then obtain solutions sufficiently correct by supposing that the motion takes place in a vacuum.

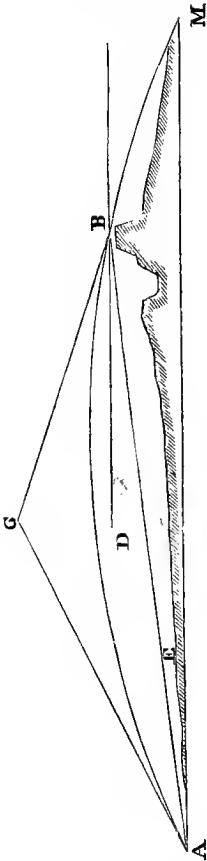
We have seen that, in the case of the parabola, the angle of fall upon the horizontal plane passing through the point of departure, is equal to the angle of fire. We conclude from this that, in ricochet firing, when the object is at the level of the battery, it is necessary to employ an angle of fire equal to the angle of arrival which we wish to attain.

But let us suppose that the angle of elevation of the object  $B A M = E$  (fig. 130) be appreciable.

If the line  $A B$  were horizontal, the two angles  $C A B$  and  $C B A$  would be equal; now, as the angle  $E$  is always very small, we can, without sensible error, suppose these two angles equal.

Let us place then

Fig. 130.



$$C A B = C B A.$$

Through the point B draw the horizontal B D; the angle C B D is equal to the angle of arrival  $i$ .

Because of the parallels B D, A M, the angle D B A = E, then

$$C B A = i + E,$$

consequently

$$C A B = i + E.$$

The angle of fire C A M = C A B + E, then

$$C A M = i + 2 E,$$

that is, that *the angle of fire is equal to the angle of arrival, plus twice the angle of elevation of the object.*

This rule gives an angle of fire which is evidently too great; consequently, the angle of arrival, which results from it, is too great. In ordinary circumstances of ricochet firing the error may go as high as  $2^\circ$ .

But we remark, that, if we had an angle of arrival accurately calculated according to the position of the point to be struck, this point could be hit only by the projectile *exactly grazing* the crest, which would limit the favorable chances of the fire; whilst, on the contrary, if the angle of arrival is a little too great, the point to be hit may be reached by a projectile passing at a certain height above the crest. It is then extremely important that the approximative formulas, serving to

calculate the angle of fire, should in no case give too low a value; but that they should give, on the contrary, a value exceeding, by one or two degrees, the angle which is strictly necessary.

Thus, for example, the angle strictly necessary to reach a point placed at 13 yards from the parapet, and at  $2\frac{1}{8}$  yards below the interior crest of the parapet, is  $9^{\circ} 27'. 40."$  If, instead of this, the angle of arrival be  $12^{\circ}$ , the point may be reached by a projectile which, instead of grazing the interior crest of the parapet, would pass  $20\frac{1}{2}$  inches above it.

Now, as the objects which we wish to reach behind the covering mass have a certain size, and as the projectile must pass at a certain height above the interior crest of the parapet, the approximative formulas give exactly what is necessary in practice.

## CHAPTER X.

## RIFLES.

**503. Inaccuracies that the Rifle is Intended to Correct.**

With the smooth bore, windage is necessary in order to allow the ball to be entered freely in the muzzle of the piece. Windage causes a great loss of power, by permitting a portion of the gas to escape through the windage ring; it also causes the ball to ballot along the bore of the piece, injuring the piece, and causing the ball to be projected in a direction due to its last contact with the bore; that is, if the last contact be on the right side of the bore, the direction given, by this contact, to the ball will be to the left of the plane of fire; if the last contact be on the lower side of the bore, the effect will be to make the ball rise above the trajectory that it was intended it should describe; and this deviation is complicated by a motion of rotation generated at the instant of the last contact of the ball with the bore, and perpetuated throughout the entire flight of the projectile. The effect of this rotation has been described in a previous chapter.

From the commencement, then, of the ball's flight, we see that it is inaccurate, but no allowance can be made for the inaccuracies arising from this cause, as it is impossible to say at what point of the muzzle the ball will last impinge. In practice, then, this cause of inaccuracy

must be ignored, and the piece must be pointed as though we knew of no such cause.

504. **Suppression of Windage not a New Idea.** The idea of suppressing windage is, by no means, a new one, and it has been put in practice, with good results, in a breech-loading piece, commonly known in the service as the *carbine*; this is a smooth-bored piece, breech-loading, having a bore a little less in diameter than the chamber in which the charge is deposited; but, although the loss of gas is prevented, it is found that the accuracy is not perfect, for the ball, being *forced* through the bore, is projected into the air deformed in shape, and like a bolt with nothing to guide it. It accordingly yields to the deviating influences brought to bear against it by the atmosphere, and takes up a motion of rotation, sometimes presenting its longer axis, and sometimes its shorter, to the resisting medium through which it passes; it remained for the *rifle* to concentrate in itself all the elements of theoretical accuracy by determining the rotation around an axis coinciding with the trajectory.

A method of suppressing windage, that obtained in practice, was to make the piece with the bore lined with straight grooves. Windage was suppressed in these pieces, and the bad effects of the shocks in the bore were avoided. The ball was of a calibre equal to that

Fig. 131.

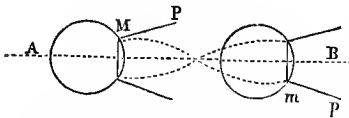


of the piece, and the straight grooves with which the bore was lined facilitated the introduction of the ball, presenting sharp edges to the sides of the projectile (fig. 131), which diminished the surface in contact with the ball, enabling it to be pushed home with but a

slight pressure of the rammer; the fouling took place at the bottom of these grooves, leaving the passage free to the ball. These grooves being made inclined instead of straight, it was immediately seen that these new grooves greatly increased the accuracy of the weapon, and a number of them were made and given to a company of cavalry called Carabins, and from this circumstance they took the name of carabines (*rifles*).

505. **Object of the Rifle Motion.** A rifle, then, is a piece having in its bore a number of grooves, helical in form, which, as the projectile passes out of the bore, give it the rifled or rotating motion. In rifles loaded at the muzzle the projectile must be made to *take* the grooves, by being forced into them. It will then turn in the piece as often as the entire curve is repeated in the length of the bore, and continue the same motion after leaving the muzzle. The rate at which it revolves will depend, for any given velocity, upon the inclination which the grooves have to the axis of the piece. The effect of imparting the rifled motion to a ball is to make it keep the same part always to the front, thus causing any deviating influence which may be exerted on one side to be counteracted by a similar effort exerted upon the symmetrically opposite point, thus enabling the ball to fulfil the condition of not departing from the plane of fire.

Fig. 132.



Suppose that the point M (fig. 132) of the front surface, be the point of application of the resultant

P M of the resistance of the air acting obliquely to the plane of fire. As the ball revolves, the point M takes

the position  $m$ , and the force  $M P$  assumes the position  $m p$ , directly opposed to the first position, and tending to throw the projectile back to the left with the same force it before exerted to throw it to the right, thus neutralizing this last motion. The force  $M P$  describes, as the ball revolves, a surface which we may take for a cone. For any two positions of the force  $M P$  opposite to each other in this cone, the deviating influences mutually counteract each other.

The ball thus preserves the same motion of rotation throughout its flight, the friction produced diminishing, equally and symmetrically, the velocity of rotation of all points of the ball, none having excess which can occasion irregularity or deviation. Thus the rifle fulfils, theoretically the condition required for accuracy of fire.

506. **Methods of Imparting the Rifle Motion.** Three methods of *forcing* the ball into the grooves have been in use—one consisted in forcing a ball, of the same diameter as the bore, down the muzzle with blows of a mallet struck on the rammer; another consisted in introducing a ball of less diameter than that of the bore, and wrapping it in a patch; and another consisted in a convenient arrangement of loading at the breech. The first method always produced a deformed ball, and was very slow of execution. The second required the ball to depend upon the patch to impart to it its rotary motion (since the ball never entered the grooves). The third method has always been open to objections in consequence of the multiplication of parts, and the complication of joints, &c.

507. **Breech Loading.** Much ingenuity has been exercised upon the subject of breech-loading rifles, and

some two or three most admirable weapons have been produced by different inventors; but the use of such a weapon will always be restricted to certain corps, as it is argued that the introducing a weapon into general use whereby the more rapid expenditure of ammunition will be encouraged, will prove a positive injury instead of an advantage. It is always urged by inventors in favor of breech-loading weapons, that they can be loaded and fired much more rapidly than pieces loading at the muzzle; there is no doubt of the truth of this assertion, but it is equally true that this would lead to great waste of ammunition, and serious embarrassment might occur from such waste. This mode of loading is safer, for no man, however awkward, can get more than one charge in the gun; no rammer is required in loading, and the ball remains in its place no matter if the gun be carried muzzle down and at a rapid rate. The last two advantages recommend it for use on horseback and in boats, and it is probable that the use of breech-loading rifles will be limited to cavalry in the army, and to boat expeditions in the navy.

The most noted arms of recent date in this country, loaded in this way, are those of Colt, Hall, Sharp, Burnside, Maynard, and Spencer; the last mentioned, being a magazine breech-loading rifle, in which eight charges are put into the stock which is fitted with a spring so arranged as to feed the bore until the last is expended. The general method of loading at the breech consists in giving to the part of the bore at the breech, a diameter somewhat greater than the other part of the barrel, and placing in it a ball larger than the diameter of the barrel, but fitting the chamber. This ball, under the action of

the powder, is *forced* into the grooves, and has to follow them, thus acquiring its motion of rotation. The multiplication of parts admits of the escape of gas at the joints, which has been an objection to this method of loading.

508. **Maynard's Rifle.** In the breech-loading rifle of Doctor Maynard, of Washington, however, this objection is obviated, particularly when used with his metallic charger, which prevents all escape of gas. In this rifle we have the greatest reduction of weight, admissable with a bullet heavy enough and using powder enough to kill at a long range. For ammunition we have a cylindrical metallic cartridge case, in which is always the same quantity of powder and always the same weight and shape of bullet. The bullet is lubricated, and set so firmly with its axis precisely in the axis of the cartridge case that it cannot be deranged by hand; the vent is small, at the centre of the bottom of the case, and covered with the same substance used for lubricating the bullets, thus keeping the powder dry, making the ammunition water-proof without impeding the fire from the primer which easily perforates the coating of lubricating substance. A forward motion of a lever (which serves also as a trigger-guard) throws up the butt of the barrel, the cartridge is inserted into a slight enlargement of the bore, which enlargement or chamber it exactly fits, thus setting the axis of the bullet in the axis of the bore; a return of the lever to its place depresses the butt of the barrel, and secures it with great firmness to the breech, the cartridge case itself *packing the joint*, and keeping its own chamber in the barrel so clean that no obstruction is ever there to interfere with loading. The empty

cartridge case is removed after firing, and such is its durability that, if half of those used be lost after the first fire, the other half can be used so many times as to reduce the cost of cartridge below the cost of the paper used in the ordinary cartridges. A small piece of iron, constitutes, with a powder flask, the entire apparatus for loading the cases.

The length of time required for loading a rifle, according to the two methods of loading at the muzzle already described, prevented the general introduction of the piece as an arm for troops. The desire was to enter the ball freely, and to make it *take* the grooves after reaching its seat. This could be done by ramming the ball after it was down, causing it to enlarge in the direction of the diameter of the piece, but this deformed the ball, and destroyed the grains of the powder.

509. **Delvigne's Rifle.** In 1843, M. Delvigne, a French officer, proposed a chamber to be screwed into the breech at the bottom of the bore, which would supply an apartment for the powder, and the shoulder of which would provide a place on which the ball could rest, thus preserving the powder. The ball, thus entering freely, was rammed and made to take the grooves; and the system was found to work so well that a number of rifles of this description were provided for troops. A sabot was subsequently attached to the under side of the ball, and attached to it was a patch of greased serge, which served to prevent fouling in the bore.

510 **Rifle à Tige.** This system was succeeded by the famous system *à tige*, which consisted in substituting for the chamber of Delvigne an iron stem of a height proportional to the charge of powder intended to be used

with the piece. The powder arranged itself around the tige, and the ball, being entered freely, rested on the tige, when, being rammed, it took the grooves. The system a tige is credited to a French officer named Thouvenin, with whom was associated M. Minié who conceived the idea of changing the form of the bullet which, until then, had always been spherical. Minié's elongated ball was of the form of a cone resting on a cylinder, around the cylindrical part of which he made a groove. This groove was designed to receive a greased woollen thread, replacing the patch of Delvigne, and designed to prevent the fouling of the bore. In the preparatory experiments made, Minié discovered that the woollen thread was inconvenient in loading; he suppressed it, and replaced it with greased paper. He observed immediately on the suppression of the thread, that the accuracy was considerably increased. The reason for this increase of accuracy will be explained hereafter.

This rifle with the elongated bullet, being found to be well fitted for troops, detailed and elaborate experiments were carried on in France, from which many points of interest were demonstrated in connection with the general subject of rifles.

511. **Grooves.** With reference to *grooves*, these experiments showed that there must be as many as two, but according to the French conclusions, they should not exceed four in number. With three the accuracy was about the same as four, but the French commission, believing that with three the bullet was not held sufficiently firm in the barrel, decided that four should be the number, and that their width should be such that *the sum of the lands should be equal to that of the grooves,*

or each groove should be equal to one-eighth of the circumference of the bore.

Experiments in the United States, however, go to show that an odd number of grooves is better, and good practice has been made with rifles having three and five grooves. This will bring each groove opposite a land, and the argument in favor of this is that, when the ball is forced by the rammer, each land tends to push the opposite side of the ball into a groove, consequently the ball is less deformed than when the number of grooves is even, when a land would be opposite a land, and a groove opposite a groove. Under all circumstances the sum of the width of the lands should be equal to that of the grooves.

512. **Twist.** With reference to *twist*, it is evident that there exists a certain relation between the twist of the grooves and the charge of powder. With grooves much inclined and a heavy charge, the bullet being of a soft metal will not follow the grooves, but will be driven across them, or will *strip*, leaving the bore deformed in shape, and without the rotary motion required; if the grooves are not sufficiently inclined, the rotary motion would not be sufficiently strong to overcome the causes of deviation. With light charges, though the ball would follow the grooves, it would not have sufficient velocity to produce effect. In proportion as the charge is large the inclination of the grooves should be slight, and as the charge is reduced the inclination should be increased.

513. **Gaining-Twist.** Rifles have been made with grooves that have very slight twist at the breech, and the twist is increased regularly until it reaches the muzzle; this is known as the *gaining-twist*. At the

instant of discharge, when the ball, from a state of rest, is instantly given a high velocity, it would seem likely to be pushed across the grooves, especially if they have a great inclination. To avoid this, the inclination of the grooves was made slight at the breech, and increased gradually toward the muzzle, at which point they were sufficiently inclined to give the necessary rotary motion. It has been decided, however, that the twist of the grooves should be uniform, owing, no doubt, to the fact that the bullet is more deformed in passing along a gaining twist than in passing along a twist that is uniform. The gaining twist has been termed the American plan of rifling, but it seems to have been discarded, except in some rifles used in the western part of our country; the U. S. rifles are all made with the twist uniform.

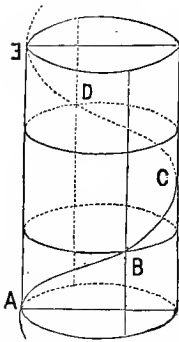
514. **Depth of Grooves.** As to the *depth of the grooves*, it is well to have them as shallow as is consistent with accuracy, for if they be very deep and the ball forced strongly into them, its surface would have projections on it which would form obstructions to its passage through the air, and would produce an injurious effect upon its accuracy during its flight. The grooves would cut away more than is necessary of the barrel, and it would be difficult to make the ball fill them. The depth established in France is .02 inch.

It is recommended by boards of U. S. Army officers, that the depth of the grooves shall not be uniform, but that they shall be cut decreasing or sloping, commencing with .015 inch at the breech, and ending at the muzzle with .005 inch; grooves, thus made, were found to have the great advantage of keeping the ball perfectly tight as it left the bore, and destroying all windage at the

muzzle, besides not cutting away the metal at this thinnest part of the barrel.

515. **The Helix.** The grooves of rifles are *helices*.

Fig. 133.



A helix is sometimes called a *spiral*. Let a point on the surface of a cylinder be submitted to two motions, one upwards parallel to the generatrices of the cylinder, the other a motion of rotation about the cylinder, parallel to the bases, and the two motions continuous and uniform; the point will take a motion resulting from the two motions acting upon it, and will describe in its move-

ment a curve of a particular form called a helix (fig. 133) This curve can be represented by means of a figure easy to construct. In a rectangle draw a diagonal, and roll up this rectangle so as to form a cylinder; this having been done, the diagonal will describe on the surface of the cylinder a curved line called a helix. The distance in a right line which separates the two nearest points of the helix upon the same element or generatrix of the cylinder is called the *turn*, or *twist*, of the helix, or measures the turn or twist. The *inclination* of the helix is the angle formed by the diagonal of the rectangle with one of the generatrices, or one of the sides of the rectangle.

We see, then, that in order to preserve the same inclination, it is necessary to preserve a certain relation between the twist and the calibre; it has been decided that the turn of the grooves should be to each other directly as the calibres, provided the projectiles are similar.

516. **Ball à Culot (wedge).** In the rifle with the *tige* it has been seen that the ball was forced into the grooves by means of the rammer; and as no two soldiers would probably employ the same number of blows, or the same force, various degrees of expansion would take

Fig. 134.



place; in some very little, while in others, from the strong blows of the rammer, great expansion and a deforming of the ball. The rifle with *tige* was also difficult to clean. The unequal expansion, produced by the varying force of the rammer, produced irregularity in the fire, and it was soon sought to supersede this manner of expanding the ball by another that should be independent, of the soldier. It was with this view that Minié invented a hollow ball with a wedge (*culot*) which was designed to expand by the action of the powder alone (fig. 134). The shape of the cavity in his ball was that of the frustum of a cone; and in this cavity was placed a piece of iron to act as a wedge. This culot or wedge, was driven before the powder into the cavity, and, by expanding the softer metal of the ball, forced it to *take* the grooves.

517. **Hollow Bullet without Wedge.** This system was found to force the ball quite as well, if not better, than the *tige*, at the same time that the ball was not deformed by the ramming, all the ramming required being just enough to prevent the ball from sliding out if the piece should be held with the muzzle down. This plan was found to fail under some circumstances, particularly with high charges, when the cup would be driven through the ball. The cup was eventually suppressed, it having been discovered that the ball could be forced

as well without the cup as with it. When fired without the wedge, the gas is thrown at once into the cavity, and acts violently upon all of its interior surface, and expands, almost instantly, the cylindrical part. But sometimes, the gas entered the fissures that were occasionally found at the bottom of the cavity, and stretching or tearing them, finished by making an opening in the conical portion of the ball. These accidents, however, do not occur when the balls are *pressed* instead of *moulded*.

518. **Pritchett Bullet.** The English still retain a wedge made of wood, which is placed in the base of the Pritchett bullet used with the Enfield rifle, and which prevents the gas from penetrating any fissures that may exist, while at the same time it is driven before the gas into the cavity expanding the ball.

Fig. 135.

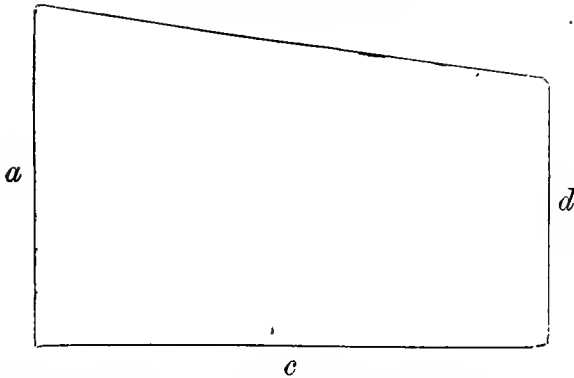
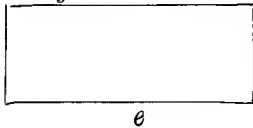
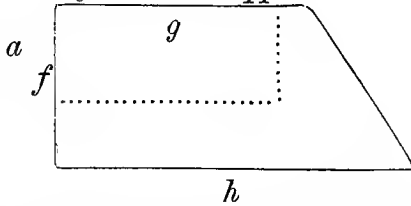


519. **U. S. Navy Bullet.** The bullets supplied to the U. S. Navy are all without wedge and pressed, cylindro-conic in form (fig. 135), conical cavity, with three grooves around the cylindrical part.

The cartridges are made up in the following manner:

The diameter of the round stick on which the powder cases are formed should be such as to make the exterior diameter of the case somewhat larger than the ball, which will prevent the outer wrapper from binding around its base when the cartridge is broken. The outer wrapper should not be made of too strong paper. The cylinder case should be made of stiff rocket paper.

Before enveloping the balls in the cartridges, their cylindrical parts should be covered with a melted composition of one part beeswax and three parts tallow.

*Outer Wrapper.**Cylinder Case.**Cylinder Wrapper.*

It should be applied hot, in which case the superfluous part will run off; care should be taken to remove all of the grease from the bottom of the ball, lest by coming in contact with the bottom of the case, it penetrate the paper and injure the powder.

The balls being thus prepared, and the grease allowed to cool, the cartridges are made up as follows: place the rectangular piece of rocket paper, called the *cylinder case*, on the trapezoidal piece, called the *cylinder wrapper*, and roll them tightly around the *former stick*, allowing a portion of the wrapper to project beyond both case and stick, close the end of the case by folding in this projecting part of the wrapper. To prevent the powder from sifting through the bottom, paste the folds, and press them on to the end of the stick which is made

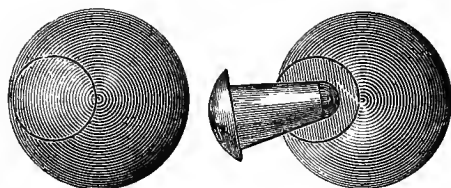
slightly concave to give the bottom a form of greater strength and stiffness; withdraw the former stick and allow the paste to dry.

When the paste is dry, the former stick is again inserted in the case, and laid upon the outer wrapper (the oblique edge from the operative, and the longer vertical edge toward his left hand) and snugly rolled up. The ball is then inserted in the open end of the cartridge, the base resting on the cylinder case, the paper neatly choked around the point of the ball, and fastened by two half hitches of thread. The former stick is then withdrawn, the powder is poured into the case, and the mouth of the cartridge is pinched or folded in the usual way.

To use this cartridge, tear the fold and pour out the powder; then seize the ball end firmly between the thumb and fore finger of the right hand, and strike the cylinder a smart blow across the muzzle of the piece; this breaks the cartridge and exposes the bottom of the ball; a slight pressure of the thumb and fore finger forces the ball into the bore *clear of all cartridge paper*. In striking the cartridge, the cylinder should be held square across or at right angles to the muzzle, otherwise a blow given in an oblique direction would only bend the cartridge without rupturing it. The ball is pushed home with the ramrod, when a single light blow of the rod causes it to expand sufficiently against the sides of the bore to prevent its falling out if the muzzle be held downward and jarred.

520. **Greener's Expansive Bullet.** The credit of the first conception of the idea of an *expanding bullet* seems, from the gentleman's own account, to be due to Mr.

Fig. 136.



William Greener, of Newcastle, England, who endeavored to have it applied to the smooth bore muskets in use in the

British Army. His proposal was made in 1836; while Delvigne's was made in 1843, and Minié's in 1847.

Mr. Greener's plan was as follows (fig. 136); an oval ball with a flat end, and a perforation extending nearly through. A tapered plug with a head like a round topped button is cast of a composition of lead, tin, and zinc; the end of the plug being inserted into the perforation, the ball is put into the piece. When the explosion takes place, the plug is driven home into the lead, expanding the outer surface, and thus suppressing all windage. If used with a rifle, of course the expansion will force the lead into the grooves.

The merit of the *principle* was not recognized by the boards of officers who experimented on it (the plan being pronounced "useless and chimerical"), and it was not until after the adoption of the Minié ball that, as Mr. Greener says, a tardy justice recognized his right to priority of invention. This was first admitted by the Emperor Napoleon III., and subsequently by the British government, who awarded to Mr. Greener the sum of £1,000 in 1857.

521. **Theory of Rifle Motion.** The range and accuracy of the rifle ball are due to the suppression of windage and the motion of rotation around an axis coinciding with the direction of translation. The suppression of windage avoids the escape of gas, thus forcing the charge

to exert its entire force in propelling the ball ; and the motion of rotation not only promotes accuracy by preserving the ball in the plane of fire, but has also an important influence on the curve of the trajectory, preventing the rapid curve which brings to the ground the ball fired from a smooth bore piece, and, as it were, supporting the ball in the air, flattens the trajectory, thus increasing the range.

522. **Drift.** The accuracy of the bullet fired with the rifle motion should be, theoretically, perfect ; but it is found, in practice, that there is a constant deviation, due to the rotary motion itself, which depends upon the manner of cutting the grooves ; for example, when the ball is made to rotate, like the hands of a clock, from left to right, the ball will deviate to the right of the plane of fire ; if the ball be made to rotate from right to left the deviation will be to the left. This deviation is termed by the French *dérivation*, and translated *drift*.

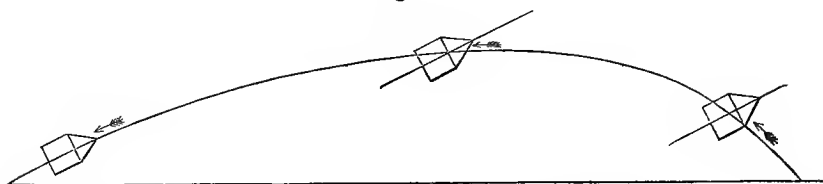
523. **Advantages of the Elongated Form.** The elongated ball, introduced by Minié, meets less resistance in its passage through the air than the spherical ball of the same calibre, especially when the latter has been flattened by being forced. This advantage is due to its pointed form. Again, the elongated balls, being superior in weight to the spherical balls fired from the same piece, do not lose their velocity as rapidly, and consequently, though the *initial* velocity may be less, after a short time their *remaining* velocity is greater than that of the spherical ball at that distance, which gives the elongated ball greater range, accuracy and penetration : this penetration is also increased by the pointed form of the front part of the bullet.

Again, we know that it is necessary to give the rifle bullet a rapid rotary motion, as well as the greatest velocity that is admissible without stripping, which two motions cannot be carried to the same extent, with the spherical as with the elongated ball; for the elongated ball does not decrease its velocity during its flight as rapidly as does the spherical ball, therefore it may have less initial velocity and consequently may be given a greater rotary motion; besides, from the form of the cylindrical part of the ball, a larger portion enters the grooves, and it is thus held more firmly in them, and is not so likely to *strip* when the grooves have much inclination.

In discussing the flight of the elongated ball, it will be found instructive, first, briefly to examine the French experiments, and to state the theories established by them.

524. **French Theory.** The bullet, during its flight, describes a trajectory which is a curve in a vertical plane, and the curvature of which is constantly changing. In order that the elongated ball should always have its point foremost, it must, as the curvature of the trajectory changes, change the position of its axis also, so as to coincide with a tangent to the trajectory. If the ball did not change its direction, but retained that in which it was projected, or, in other words, if its axis remain parallel at the different parts of its flight to the position of its axis as it left the piece, the angle formed by the axis with the direction of the motion of translation would change continually (fig. 137). The amount of the resistance of the air would vary with the amount of surface offered to it by the ball. The direction of

Fig. 137.



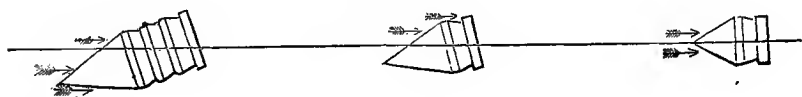
this force would not always pass through its centre of gravity; it would therefore have a tendency to take up a different motion of rotation from that it had received from the grooves in the barrel. It is therefore necessary so to arrange the projectile that the resistance it meets in passing through the air shall tend to keep its axis of rotation constantly tangent to the trajectory.

525. **Grooves on the Bullet.** The elongated bullet, first experimented on, had a groove around the cylindrical part. This groove was designed to attach the cartridge to, and to hold a greased thread. A change having been made in the manner of attaching the cartridge to the ball, this groove was omitted as useless; the accuracy of fire was found to be diminished. The groove was replaced, and it was found by experiment that the slightest change in its shape or position had much influence on the accuracy of fire. Not only any change of the groove, but any alteration of the shape of the ball, altered the results of the fire. M. Tamissier, whose name is intimately associated with the French experiments, experimented with a ball the point of which was a cone, and the rest a cylinder; he varied the lengths of each part, and determined that these variations always produced variations in the accuracy of fire.

M. Tamissier concluded that in order to increase the accuracy of the elongated bullet, it was necessary to

cause the greatest resistance from the air to act as far as possible behind the centre of gravity. He, at first, tried to carry this centre as far forward as possible, but in so doing made the front part of the bullet too round, which caused an increased resistance to its passage through the air. Further researches caused him to employ another method to preserve the proper position of the ball at each instant of its flight. This was to cause greater resistance of the air on the hinder part of the ball whenever its axis did not coincide with the direction of its motion. He made on the cylindrical part, instead of the single groove heretofore used, as many grooves as possible. The accuracy of fire was much increased. According to his theory, the grooves on the cylindrical part of the ball offer an equal resistance on all sides to the air when its point is in the direction of the motion of translation (fig. 138) but as soon as the point leaves

Fig. 138.



this direction, the resistance of the air, which acts in a direction directly opposite to that of the motion of translation, exerts its influence unequally upon the rear of the ball, the grooves supplying means through which it can act with more power than if the surface were smooth. Consequently, the grooves on the side which is inclined forward are exposed to the action of the air, and experience a greater resistance than those on the side which is inclined to the rear, which, he thought, caused them to turn the ball about its centre, and tended to lead the point back in an opposite direction to the

one in which it was deviating, this tendency being stronger and more instantaneous as the grooves are farther to the rear.

The reasonableness of this conclusion will be apparent from an inspection of fig. 138, where if the axis of the ball be in the direction of its line of flight, the air's resistance would be exercised symmetrically upon the conical part, and would cause no deviation; but if the axis deviate in any direction, to the right, left, above or below, the resistance of the air, acting almost perpendicularly upon the opposing sides of the grooves, would seem to tend powerfully to bring back the axis in the direction of its line of flight. There can be no doubt that this would be the effect were the ball simply moving through the air with no motion of rotation; but (as will be shown under the Magnus theory) when the ball has a motion of rotation, such a force as is supposed to be exerted on the rear of the ball would have the effect of inclining the apex in a different direction from the one supposed.

526. The effect of the resistance of the air is illustrated by the spinning of a top, and the flight of an arrow. When a top is spun, its axis, though at first greatly inclined while it has a rapid rotary motion, raises itself by degrees, and ends by turning on its point, its axis vertical, and apparently standing still. The top is prevented from falling, and kept in an upright position, by the resistance of the air caused by its rapid rotary motion.

527. The bullet, in its flight, has, in addition to the rotary motion of the top, a rapid forward motion.

The arrow has only a forward motion, its greatest

*boards, not reser-  
vance of a ball*

weight being nearest its head; the centre of gravity approaches that end. On the opposite end feathers are placed, which, being very light, vary but little the position of the centre of gravity, but offer resistance to the air, and prevent the arrow from descending, as it is impelled, by the force of gravity.

The feathers also prevent any rotary motion in a direction perpendicular to its axis, and keep the arrow in the direction of its flight, thereby causing the curve of the trajectory to be more flattened than it would be without them. The arrow, being made long, does not expose a large surface, in proportion to its weight, to the resistance of the air.

528. The grooves on the elongated ball were supposed to act, in preserving the direction of the bullet, in a manner in which we have shown the air to act in regard to the top and the arrow. In the forward motion of the bullet, the grooves on its hinder part were supposed to have something of the effect of the feathers on the arrow; and, in the rotary motion, these grooves, like those upon the top, serve to increase the surface upon which the air acts.

The practical effect of the grooves is shown by the following record: the mean drift of elongated balls without grooves, fired from rifles with grooves of one turn in six feet three inches, was ten feet in 872 yards; but with grooves this drift was inappreciable at the same distance.

529. **French Theory of Drift.** *Drift*, as has been already stated, is the deviation of the rifle ball due to the rifle motion. The French explain the cause of drift in the following manner: while the ball keeps point fore-

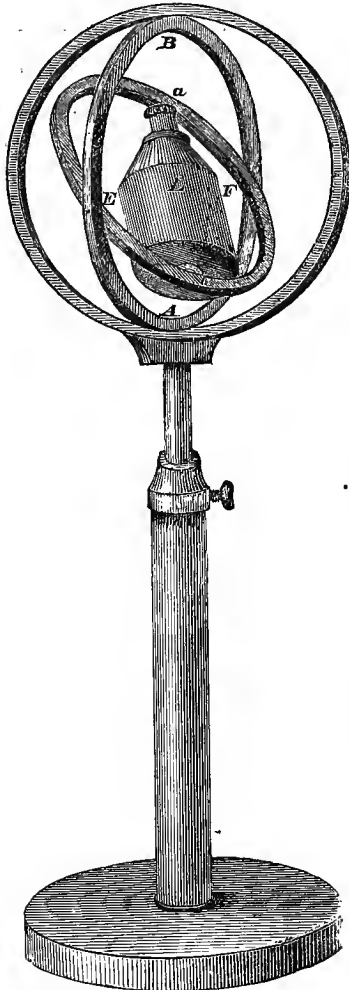
most, the resistance of the air to its rotary motion is equal on all sides, and causes no deviation; but, in the course of the flight, the ball fired with the point elevated above the horizontal, from its tendency to maintain its axis parallel to what it was at the commencement of its flight, will cause its point to vary from the curve described by its centre of gravity; the point will remain above, and the larger portion of the ball below the curve of the trajectory. The forward motion of the ball causes a pressure of the air against it, which resists the rotary motion on its front or forward part. Now if the ball, in this situation, revolve around its axis from left to right, there will be a greater resistance to the rotary motion on the front and under side than on the rear and upper side of the ball; the front side of the ball will yield to the greater resistance, and the rear side will have greater velocity of rotation; the ball will incline to the right. When the grooves give a rotary motion to the left, the ball will go to the left.

It is this deviation which the grooves on the ball are designed to correct, and which, according to the French theory, is effected in the manner just described.

530. **Magnus' Theory of the Deviation of Elongated Projectiles.** Thus far we have followed the French in their theory of the cause of drift, and of the effect of the grooves on the elongated ball; it is evident that they entertain the idea that the deviation is to be especially attributed to the greater pressure of the air upon the under and more forward part of the projectile, causing the ball to roll over, as it were, in the direction in which it is rotating, but this idea is not borne out by the results of practice; for if this were the sole, or even the

chief reason of the deviation, *the greater the comparative rapidity of rotation, or the quicker the turn of the grooves, the greater would be the deviation*: whereas, we find by increasing the rotary velocity of the shot without increasing its translatory velocity, a contrary effect is produced.

Fig. 139.



Professor Magnus, of Berlin, has a theory on this subject which satisfies the results of practice, he illustrates with the *gyroscope* (fig. 139). If, during the body's rotation, a force not passing through the centre of gravity, be applied to the axis, for example, if, when the axis of the body is inclined to the horizon, a vertical force act on it near to the extremity of the axis, then the latter will not be moved by it in a vertical plane, but will describe a cone, in that it begins to move very slowly and *horizontally* toward one side. If the force act in a horizontal instead of a vertical direction, the axis describes still a cone, but commences moving very slowly and *vertically*, upwards or downwards. *This motion has al-*

*ways a direction perpendicular, or approximately so, to the plane passing through the direction of the force and the axis of rotation.*

Suppose the observer placed in the production of the axis of rotation through the base, sees the body rotate in the same manner as the hands of a clock, or from left to right, and that the force acts from below upwards on the extremity of the axis turned from him, that is, on the apex, then this apex will move toward the right of the observer; if, on the other hand, the force acts from above downwards, the apex will move to the left. If the force be applied to the extremity nearest the observer, then the apex moves to his left when the force acts from below upwards; to his right, however, when it acts from above downwards. If the rotation was in an opposite direction, or from right to left, then the extremity, turned from the observer, would in each of the above cases move in an opposite direction to the one mentioned.

531. Now the elongated projectile is discharged from the piece with its axis coinciding with its trajectory, but, through the action of gravity, the trajectory deflects from its original direction, and from that of the axis. In consequence of this, the resistance of the air acts obliquely to the axis, and, with the ordinary forms of elongated projectiles *without grooves*, its resultant passes in front of and above the centre of gravity,\* tending to raise the point, and from this results the conical motion of the axis to the right, if the rotation be to the right, to the left in the contrary case.

As long as the resultant of resistance is in the same

\* This is satisfactorily shown to be the case in the Professor's experiments.

vertical plane with the axis of the projectile, the motion of the apex will be to the right (supposing the rotation, to the right), for the deviation, as stated before, is perpendicular to the plane passing through the direction of the force and axis of rotation; but as soon as this motion has commenced, the plane, passing through the resultant of resistance and through the projectile's axis, is no longer vertical, and the more this deviation of the apex increases, the greater becomes the inclination of this plane. But, as we have seen, the apex moves always perpendicular to this plane, or approximately so; hence, from the known direction of this motion, it follows that the apex must be depressed. This depression of the apex can extend even so far that it becomes situated below the tangent through the centre of gravity. Then the resistance of the air, parallel to the tangent, acts from above downwards on the apex, and thereby a motion of the apex ensues in a direction opposite to that just mentioned; continue the subject, and it will be seen that the axis will describe a helical revolution around the trajectory, if its flight last for a sufficient length of time.

During the projectile's flight, however, owing to its short duration, so great a depression of the apex is not to be expected, and Major Barnard, of the United States Army, gives as his opinion, in a paper on this subject, that in most cases, if not in all, no complete revolution takes place at all, but that the whole motion is confined to the first quadrant. In this case, the flight of the projectile would exhibit one continuous and constantly increasing deviation to the right (supposing the rotation be to the right).

532. This will account for the drift; and moreover, the more rapid the rotation, the greater difficulty will there be in moving the axis of rotation (as can be readily tested by the gyroscope), hence the less must be the deviation, which satisfies the results of practice in that respect, where the French theory is found to be defective.

533. We have supposed the projectile without grooves, but it has been found that grooves around the cylindrical portion of the projectile promote accuracy. It is desirable then to determine in what manner they effect the object. Their object, according to Tamissier's theory, was to *tilt* the ball, bringing down the apex, thus preventing the axis from remaining parallel to its first position; but it has been shown that this very drooping of the apex is a natural consequence of the rotation of the ball as soon as the apex deviates from the plane of fire. According to the theory described above, the manifest effect of the grooves is to increase the surface, in rear of the centre of gravity, exposed to the resisting influence of the air; this will have the effect of bringing the resultant of resistance more to the rear, in fact causing it to pass through the centre of gravity instead of between it and the apex, and this will prevent the deviation from the plane of fire consequent upon the resultant of resistance passing through the axis between the centre of gravity and the apex. The tendency, then, of the grooves is to retain the axis parallel to its first position, making it comparatively rigid, and preventing the apex from deviating or drooping.

534. It is desirable, however, that the projectile should strike with its point foremost, but if the trajec-

tory be curved too rapidly in order to bring about this result, the range will be shortened. The tendency of the resistance, however, being to retain the axis parallel to its first position, the trajectory will be evidently flattened, and the range increased; while a judicious placing of the centre of gravity of the projectile before the centre of figure will have the effect of causing the apex to sink so gradually as not to interfere with the flattening of the trajectory.

In all expansive bullets, the cavity formed at the base has the effect of thus throwing forward the centre of gravity, and the fact that the bullet strikes the object point foremost is due, mainly, to this cause, and not to the influence exerted by the grooves. This is evident from the fact that the Pritchett bullet (fired from the Enfield rifle), which has no grooves around it, strikes the object point foremost.

It is probable that the upper and rearmost side of the ball, experiencing less of the resistance than the lower side, may, in consequence of this, have a greater velocity of translation than the lower side, and may thus have the effect of gradually overcoming the rigidity of the axis; this cause would operate in the case of the bullet without grooves, as well as of the bullet with grooves.

In fine, the grooves cannot have the effect of *tilting* the bullet, for, supposing that there was produced a tendency to lift the rear end of the ball, this force would be exhibited in inclining the apex to the left instead of causing it to droop (supposing always the rotation to be from left to right).

535. To recapitulate: Professor Magnus' experiments go to show that in elongated projectiles without grooves,

the resultant of the resistance of the air passes through the axis between the centre of gravity and the apex; that the effect, consequent upon this, is to incline the apex in a direction perpendicular to the plane passing through the direction of the resistance and the axis of rotation; that the direction of this plane is constantly varying, causing the deviation of the bullet to describe a spiral around the general line of direction of the flight; that this motion, though constant, is slow, so much so that in the time occupied in the flight of the projectile there is described only a portion of the first quadrant.

The grooves on the cylindrical part of the ball, by increasing the surface, in rear of the centre of gravity, subjected to the resistance of the air, cause the resultant of the resistance to pass through the centre of gravity, thus preventing the deviation from the plane of fire which is caused when the resultant passes between the centre of gravity and the apex. No cause, then, operating to produce a deviation to one side or the other, the rotation has an opportunity of developing its peculiar property, which is to preserve the axis rigid; this rigidity, however, is slowly overcome by the centre of gravity being situated before the centre of figure, the effect of which is to bring down the apex slowly so as to permit the bullet to strike the object with the point foremost.

536. We see from this, that the effect produced by the grooves is the same as if we carried the centre of gravity farther forward in the bullet; and thus to make a bullet without grooves equal in accuracy to a bullet with grooves it is necessary that its forward part should be much more rounded; and this is the case with the Pritchett bullet, used with the Enfield rifle, which has

its sides smooth and the centre of gravity thrown forward much farther than is the case with the French or United States bullets, both of which are more pointed in form at the forward end than is the English bullet.

537. The experiments of Professor Magnus with the gyroscope are so satisfactory that his conclusions may be safely taken as establishing the true theory of the rifle motion, and the deviations peculiarly due to it. The influence of the grooves around the cylindrical part of the bullet, as just stated, seems to be a fair deduction from the results arrived at by Magnus, and is submitted as the probable manner in which they operate to promote accuracy.

538. **Rifled Cannon.** Many attempts have been made to apply the rifle principle to guns of large calibre, but up to the present time the success of inventors in this line has not been such as to warrant the introduction of rifled cannon, to any great amount, in the batteries of ships; although for light pieces for the field, and boat howitzers, the application of the system seems to be approved of to a considerable extent. The importance of the question is much enhanced by the fact that the moment a successful plan is discovered, the problem of percussion shells is solved.

Large projectiles, being made of iron, cannot, of course, be forced into the grooves of a gun like the leaden ball of small arms. All projectiles designed for rifled cannon are elongated in shape. Some have been made with spiral grooves, or projections, on the after surface, through which the gas, as it rushed, produced the rotary motion; others have these grooves on the fore part of the ball, and the rotation is produced by the action of

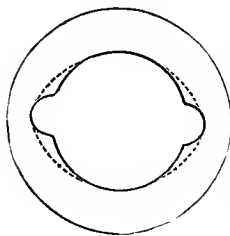
the air on them as the ball moves forward ; but although the effect was produced by these two methods in a slight degree, the force of rotation developed was not sufficient to insure the direction of the ball with any certainty.

Attempts have been made to cast on the outside of the cylindrical part of the shot some softer metal, such as lead, or composition, to take the groove and give the necessary rotation ; but it has generally been found that, although these metals take the grooves at first, they are torn off by the force of the powder.

539. **French Rifled Cannon.** The French have long been making experiments upon a cannon with two grooves, having an elongated projectile with buttons on the sides to fit into the grooves. Increased range and accuracy seem to be attained, but no dependence can be placed on them for any length of time, as the slightest obstruction or difficulty of the projectile in making its exit inevitably bursts the gun.

540. **Lancaster Gun.** The English *Lancaster gun*, so called from its inventor, and which was employed during the late war with Russia at an enormous expense to the British government, seems now to be acknowledged as a perfect failure, and has fallen entirely into disuse. To

Fig. 140.



get an idea of the form of the bore of this gun, suppose figure 140 the section of a rifle with two grooves, having a *gaining twist* ; if we cut away the metal about the grooves until the bore will be represented by the dotted curve, we have a cross section of the elliptical bore of the Lan-

caster gun. The projectiles fired from this gun expe-

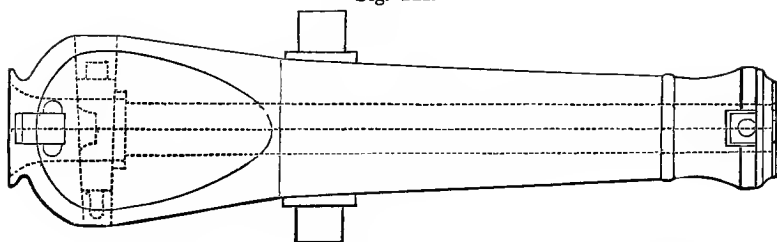
rienced great difficulty in forcing their way through, and the guns, consequently, frequently burst; it was also noticed with this gun that the projectiles were frequently broken, even when made of wrought iron. The manufacture of this gun was very difficult and expensive, the shell used with it was complicated and difficult of manufacture, and the serving of the gun was very troublesome, requiring much habitual skill, or knack, in introducing and setting the shell home through the turning of the bore; and it is not unlikely that, in some instances, the bursting of the Lancaster guns was occasioned by the oval ball leaving a space between it and the cartridge, or by getting fixed in the gun by change of position whilst it was being propelled through the oval bore.

This plan of rifling has also been applied to small arms, but with much better success.

**Rifled Cannon Loaded at the Breech.** The practice of loading guns at the breech is not of modern date, as will be seen by referring to the description, given in chap. I., of the guns recovered from the "Mary Rose," sunk in 1545.

541. **Cavalli Gun.** In 1846, iron rifled cannon, capable of being loaded at the breech, were invented by Major Cavalli, of the Sardinian artillery, and Baron Wahrendorff, a Swedish noble, for the purpose of firing cylindrical and cylindro-conoidal shot. In these guns the mechanical contrivances for securing the breech are very superior to the rude processes of earlier times, yet it is very doubtful whether, even now, they are sufficiently strong to insure safety when high charges are used in long continued firing.

Fig. 141.



The length of the Cavalli gun (fig. 141) is 8 feet 10 inches, weighs 66 cwt., and its calibre is  $6\frac{1}{2}$  inches. Two grooves are cut spirally along the bore, each of them making about half a turn in the length, which is 6 feet 9 inches. The chamber is cylindrical. With respect to windage, it must be observed that in all rifles with forced leaden shot of any shape, there is practically no windage, and, accordingly, no waste of the charge: but it is not so with iron shot fired from rifled cannon, since the iron cannot be made to expand so as to fill the bore and enter into the grooves; there must, consequently, be some windage; and, in fact, if there were not some, or if the charge were not greatly reduced, the blowing off the breech, an accident which happened to M. Cavalli's own gun, would be of frequent occurrence.

Immediately behind the chamber there is a rectangular perforation in a horizontal direction and perpendicular to the axis of the bore; its breadth vertically is  $9\frac{1}{2}$  inches, while horizontally it is 5.24 inches on the left side, and 3.78 inches on the right side. This perforation is to receive a wrought-iron case-hardened quoin or wedge, which, when in its place, covers the extremity of the chamber which is nearest the breech. The projectile, cylindro-conical or cylindro-conoidal in form, being introduced through the breech and chamber into the bore

of the gun, and the cartridge placed behind it, a false breech of cast iron is made to enter  $2\frac{1}{2}$  inches into the bottom of the chamber behind the cartridge; and a copper ring, which also enters the chamber, is placed over it. The iron wedge is then drawn toward the right hand till it completely covers the chamber. After being fired, the gun can be reloaded without entirely taking out the wedge; for the latter, which is shorter than the rectangular cavity in which it moves, can be withdrawn far enough to allow the new load to be introduced.

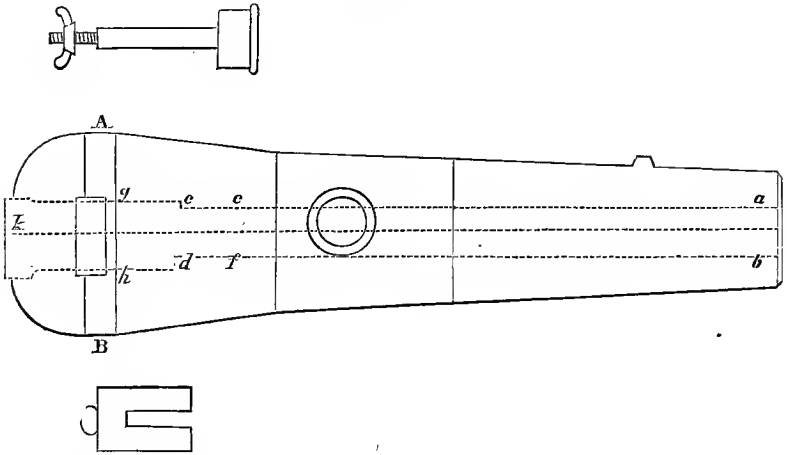
Experiments made with this gun have given the following results, shells being fired from it with charges equal to one-tenth of the weight of the projectile:

Elevation.	Mean Range.	Mean Deviations.	
		To the Right.	To the Left.
10°	3058 yds.	3.4 yds.	3.39 yds.
15°	4128 "	11.0 "	1 ft. 11 in.
20°	4917 "	6.1 "	10 yds.
25°	5563 "	3.0 "	4 "

These trials were considered highly satisfactory.

542. **Wahrendorff Gun.** The rifled gun constructed by Baron Wahrendorff differs in some respects from that of Major Cavalli (fig. 142). Its whole length is 8 feet 11 inches, and its greatest diameter, *A B*, 2 feet 3 inches. The diameter *a b* of the bore is 6.37 inches from the muzzle to within 6 inches of the chamber, in which space, *c d e f*, it has a conical form, the diameter *c d* being 9.65 inches; the diameter of the chamber *c d g h* is 7.5 inches. A rectangular wedge, 12.2 inches long, 8.1 inches broad, and 4.25 inches thick, is made to slide toward the right or left hand, in a perforation formed transversely through the breech, for the purpose of covering, after the gun is

Fig. 142.

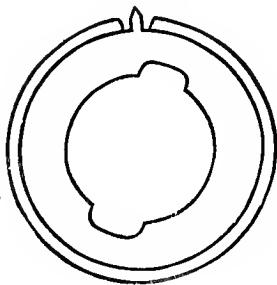


loaded, the aperture by which the charge is admitted into the bore. A notch, 7.2 inches long, and .7 inch broad, is made longitudinally in the wedge, and through this passes the stem, or bar, of a cylindrical plug, by which the charge is kept in its place. This plug is 7.4 inches diameter, and 4.7 inches long, and it is provided with a stem, or bar, 15.75 inches long, at the extremity of which is a screw nut having two handles. The plug is introduced in the direction of the axis of the gun, through an orifice in the breech, and its stem passes through a perforation made in an iron door which closes the orifice. When the gun is loaded, the door is closed; the plug is pushed forward to the rear of the charge by means of its stem, and the wedge is made to slide into its place: a turn of the screw nut at the end of the stem is then taken, when the whole is drawn tightly together and is ready for firing. After firing, the wedge is drawn out as far as a pin, which fits into a groove in its top, will permit; and this just allows the plug to be drawn back

close to the door, which is hollowed, as at *k*, to receive it; the door will then open so that the plug may be withdrawn from the breech of the gun, preparatory to reloading.

543. **Wahrendorff Carriage.** A peculiar carriage was proposed by Baron Wahrendorff for use with his gun, which appears to be fit for casemates. The upper part of the carriage has, on each side, the form of an inclined plane, which rises toward the breech, and terminates at either extremity in a curve. Previously to the gun being fired, the trunnions rest near the lower extremity; and on the discharge taking place, the gun recoils on the trunnions, along the ascending plane, when its motion is presently stopped. After the recoil, the gun descends on the plane to its former position, where it rests after a few short vibrations. The axis of the gun constantly retains a parallel position, so that the pointing does not require readjustment after each round. The gun was worked easily by eight men, apparently without any strain on the carriage. With a charge of 8 lbs., and with solid shot, the recoil was about 3 feet, and the trunnions did not reach the upper extremity of the inclined plane, though the surface was greased.

Fig. 143.



544. **Napoleon Cannon.** The Napoleon gun, or French rifle cannon, is a two-grooved piece, a section at the muzzle of which is represented in fig. 143. This gun has a twist of about one turn in twenty feet. The information that can be collected on the subject of French ordnance is very meagre,

but guns of this pattern were adopted for many of the gun-boats fitted out by France for operations in the Baltic in 1856; some being armed with two, and others with four guns. Its adoption in so important an enterprise as against the Russian defences, indicates great confidence in its excellence; in confirmation of which Colonel Delafield mentions having seen, in 1856, large piles of the shells, amounting to many thousands, in depot, all apparently

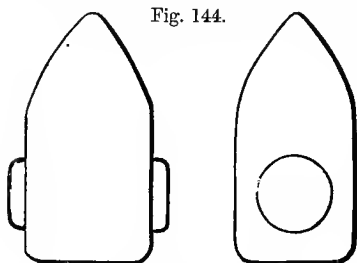


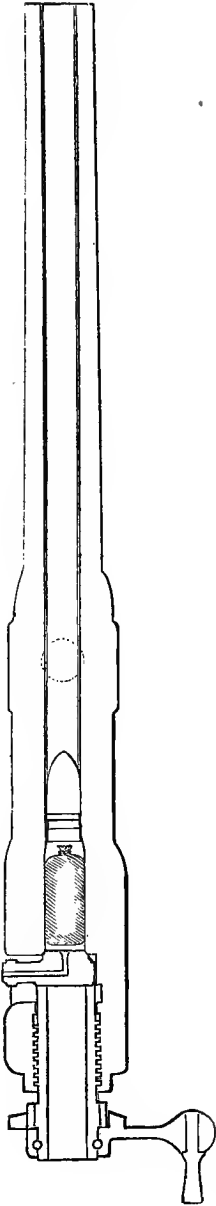
Fig. 144.

new. The shell used with the French rifled cannon is represented at fig. 144. The shell is of cast-iron, having a segment of a sphere (nearly) cast on its cylindrical part.

**545. The Armstrong Gun.** The most successful rifled cannon that has, as yet, been proposed, is the invention of Sir William George Armstrong. In 1854 Sir William (then Mr. William) Armstrong submitted his proposal, and in 1855 he completed a gun which became the subject of a long course of experiments, which led ultimately to the introduction of the weapon into the British service.

His first gun was composed internally of steel, and externally of wrought iron, applied in a twisted or spiral form as in a fowling piece. The bore was about two inches in diameter, and rifled with numerous small grooves. The projectile was a pointed cylinder  $6\frac{1}{2}$  inches long, and its weight was 5 lbs.; it was made of cast-iron coated with lead, and was fired from the gun with a charge of ten ounces of powder. It contained a small cavity in the centre, and was adapted

Fig. 145.



to be used either as a shot or as a shell. When applied as a shell the cavity was filled with powder, and a detonating fuze was inserted in front so as to fire the powder on striking an object. When used as a shot, the powder was omitted, and a plug substituted for the fuze. The gun was constructed to load at the breech, the object being not only to obviate the disadvantage of sponging and loading from the muzzle, but also to allow the projectile to be larger in diameter than would enter at the muzzle, and thus to insure its taking the impress of the grooves and completely filling the bore. The piece weighed 5 cwt.

With this small piece, at a distance of 1,500 yards, and with an angle of fire of  $4^{\circ} 26'$ , a target of  $7\frac{1}{2}$  feet high and 5 feet wide, was struck eight times in succession; and, at the same distance, a shot was fired quite through a timber butt 3 feet thick, and composed of six layers of elm so as to form a solid block.

The satisfactory results obtained with this small gun led to the construction of a larger one, which exhibited the advantages of the system in a much higher degree. In this

second gun the steel lining was dispensed with as being difficult of manufacture, and uncertain in its soundness. Instead of being internally of steel and externally of wrought iron, the gun was composed entirely of the latter material; the essential feature in its mode of manufacture being the combining, into one mass, of tubes made from iron bars twisted into a spiral form, and welded by hammering.

The weight of this new gun was 12 cwt., the projectile weighing 18 lbs. The arrangement for loading at the breech was the same as in the first gun, and may be described as follows, (fig. 145). A large screw was inserted in the breech, and had a hole through it forming a prolongation of the bore. Through this hollow screw the gun was sponged and loaded. In order to close the breech when the gun was loaded, a steel stopper (or vent and breech piece) was inserted at an opening in the upper side of the gun, and was tightened by the screw against the end of the bore, a projection of softer metal on the forward face of the stopper, entering the bore behind the cartridge, which expanding at the discharge effectually packed the joint, preventing any escape of gas. The vent for firing the gun was contained in this stopper. The handle or lever for working the screw was made to move freely through half a circle, and, at each extremity of its range, to act like a hammer against a stop or clutch, so that a blow might be given in either direction to tighten or slacken the screw.

546. Sir Howard Douglas, from whom the above description is taken, adds still further, "The gun is composed wholly of wrought iron, and the prominent feature in its manufacture is the application of the material

in the form of long bars, which are coiled into spiral tubes, and then welded by forging. For the convenience of manufacture, these tubes are made in lengths of from two to three feet, which are united together, when necessary, by welded joints. From the muzzle to the trunnions the gun is made in one thickness, and is therefore, so far as that portion is concerned, strictly analogous to the barrel of a fowling piece. Behind the trunnions two additional layers of material are applied. The external layer consists, like the inner tube, of spiral coils, but the intermediate layer is composed of iron slabs bent into a cylindrical form and welded at the edges. The reason for this distinction is, that the intermediate layer has chiefly to sustain the *thrust* on the breech, and it is therefore desirable that the fibre of the iron should be in the direction of the length, whilst elsewhere in the gun it is more advantageously applied in the transverse direction."

547. We will describe more fully this important principle which has been so happily applied in the construction of the Armstrong gun. Let us suppose a hollow cylinder, say twelve inches long, the calibre being one inch in diameter, and the walls one inch thick, giving an external diameter of three inches. Suppose this cylinder to be perfectly and firmly closed at its ends by any sufficient means. Let this be filled with gunpowder, and fired. The fluid will exert an equal pressure, in every direction, upon equal surfaces of the sides and ends of the hollow cylinder. Let us next examine the resisting power of a portion of this cylinder, say one inch long, situated in the middle, so that it shall not be strengthened by the iron which is beyond the action of

the powder. The fluid enclosed by this ring of one inch long contains an area of one square inch, if a section be made through it in the direction of its axis; and the section of the ring itself, made in the same direction, will measure two square inches. We have then the tenacity or cohesive force of two square inches of iron in opposition to an area of the fluid measuring one square inch; and if we take the tenacity of the iron at 65,000 pounds, the cylinder will not be burst, in the direction of its length, unless the expansive force of the fluid exceed 130,000 pounds to each inch.

Next, let us suppose a section made through the cylinder and fluid transversely. The area of the fluid, equal to the square of the diameter of the hollow cylinder, is one circular inch; and the area of the whole section, the diameter being three inches, is nine inches. Deduct from this the area of the calibre, and we have eight circular inches; that is, the section of the iron is eight times greater than that of the fluid; whereas, in the former case, of longitudinal section, the iron gave but twice as much surface as the fluid; and if we take, as before, the iron at 65,000 pounds per inch cohesive force, it will not be broken unless the force of the fluid exceed 520,000 pounds.

Here then is a principle, or rather a fact, of the utmost importance in forming cannon of any material, the strength of which is different in different directions; for, as a cannon made in the proportions above specified, if the materials be in all directions of equal strength, will possess four times as much power to resist a cross fracture as it does to resist a longitudinal fracture, it follows that a fibrous material which possesses four

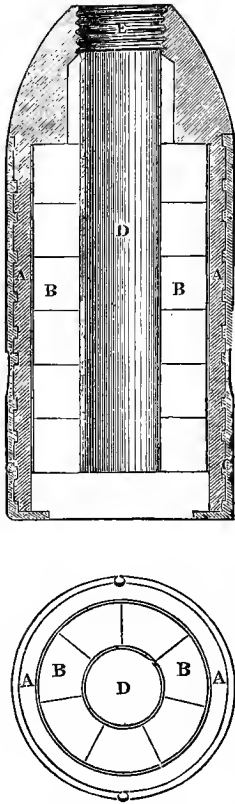
times the strength in one direction that it does in another, will form a cannon of equal strength if the fibres be directed round the axis of the calibre. It is this fact which gives the great superiority to the various kinds of twist gun-barrels; for in these, although the fibres do not enclose the calibre in circles, yet they pass around it in spirals, thus giving their resisting force a diagonal direction which is vastly superior to the longitudinal direction in which the fibres are arranged in a common musket barrel.

548. In the Armstrong gun, it will be perceived that the inventor has arranged his metal in the form of spirals where that position of the fibres was most advantageous, and he also changed the direction of the fibres where the *thrust* is received from the recoil, in such a manner as to present the greatest strength of the material at that point to the force there exerted, thus thoroughly applying the principle just explained.

549. To resume the description of the gun, as given by Sir Howard Douglas, "The back end of the gun receives the breech-screw, which presses against a movable plug, or stopper, for closing the bore. The screw is hollow, and, when the stopper is removed, the passage through the screw may be regarded as a prolongation of the bore. The bore is three inches in diameter, and is rifled with thirty-four small grooves. The bore is widened at the breech end one-eighth of an inch, so that the shot may enter freely and choke at the commencement of the grooves."

550. **Armstrong's Shell.** "The projectile (fig. 146) consists of a very thin cast-iron shell, the interior of which is composed of forty-two segment-shaped pieces

Fig. 146.



of cast iron, built up in layers around a cylindrical cavity in the centre, which contains the bursting charge and the concussion arrangement. The exterior of the shell is thinly coated with lead, which is applied by placing the shell in a mould, and pouring melted lead around it. The lead is also allowed to percolate among the segments so as to fill up the interstices, the central cavity being kept open by the insertion of a steel core. In this state the projectile is so compact that it may be fired through six feet of hard timber without injury; while its resistance to a bursting force is so small that less than an ounce of powder is sufficient to break it in pieces. When this projectile is to be used as a shot, it requires no preparation; but the expediency of using it in

any case, otherwise than as a shell, is much to be doubted."

551. The fuze is complicated, combining the time-fuze with two applications of the concussion system. As the shell fits accurately into the gun, there is no passage of flame by which the fuze could be ignited. To make it available as a shell, the bursting-tube, the concussion arrangement, and the time-fuze are all to be inserted; the bursting-tube entering first, and the time-fuze being screwed in at the apex, somewhat resembling

the Borman time-fuze. If then the time-fuze be correctly adjusted, the shell will burst when it reaches within a few yards of the object ; or, failing that, it will burst by the concussion arrangement, when it strikes the object, or grazes near it. The shell can also be made to explode at the muzzle of the piece, thus answering the purpose of canister ; in every case the shell on bursting spreads into a cloud of pieces, each having a forward velocity equal to that of the shell at the instant of fracture. The shell evidently possesses more of the characteristics of the shrapnel than of the shell, thus making it very formidable against boats or open bodies of troops, but its small bursting charge must make its explosive effect (in a ship's side, for example,) comparatively contemptible.

The concussion arrangement, for igniting the time-fuze, and (in case of the failure of the time-fuze) for the communicating flame directly to the bursting charge in the shell, is effected by means of two cylindrical cavities in the centre of the fuze; at the forward end of one and at the rear end of the other there is deposited a small quantity of detonating composition. A striker with a point is secured in each cylindrical passage by a pin which is broken by the shock of discharge, liberating the strikers and allowing them both to recede to the rear-most extremity of their respective passages. One of the strikers has its point to the rear, and the other has its point to the front. When the strikers are liberated, the one with its point to the rear, pierces the detonating composition deposited in the rear part of its chamber, thereby generating a flame which is communicated to the composition of the time-fuze. Should the

shell not explode before it strikes the object, its explosion at the moment of impact (or immediately subsequent thereto) is insured by the second striker, which, as soon as the shell strikes the object, rushes forward, piercing the detonating composition deposited in the front part of its chamber, thus generating a flame which is communicated directly to the bursting charge in the shell.

552. The process of loading is effected by placing the projectile, with the cartridge and a greased wad, in the hollow of the breech-screw, and thrusting them either separately, or collectively, by a rammer into the bore. The stopper is then dropped into its place and secured by half a turn of the screw.

553. These guns are always supplied with spare stoppers, as they are frequently destroyed; this is one of the objectionable features of this gun; should any dirt or sand get into the thread of the breech screw it might unfit the piece for service; this is another important point to be considered with this gun, as also the chance of the breech-screw being made to increase in size in the direction of its diameter by the force of the stopper against it. Sir Howard Douglas, however, after describing the gun, does not seem to find any fault with it, neither does he commit himself to any decided approval of it as a substitute for the ordnance now in use on board ship; but the silence that is preserved upon the performance of the weapon during the late expedition to Peking, would seem to suggest a doubt as to its having realized the anticipations that had been entertained of it when brought into actual use in the field. Enough has leaked out to give the impression that at least the

ammunition is imperfect, owing to the action excited between the iron and the rings of lead.

554. **Inability of the Armstrong Gun to Resist Impact.** One fact in relation to the Armstrong gun has been fully proven, viz.: that it cannot resist the impact of a shot fired from a 9-pounder bronze gun, at 100 yards distance. This experiment, which was made at Woolwich, clearly showed the helplessness of the gun to resist the wounds that a field gun must be expected to suffer.

The first shot fired struck the Armstrong gun in front of the trunnions, breaking through, and causing the muzzle to droop  $12^{\circ}$ .

The second shot struck it behind the trunnions, causing the whole of the gun in front of the trunnions to fall to the ground.

The third shot struck the gun in the thick part of the breech, utterly breaking the gun up in its thickest part.

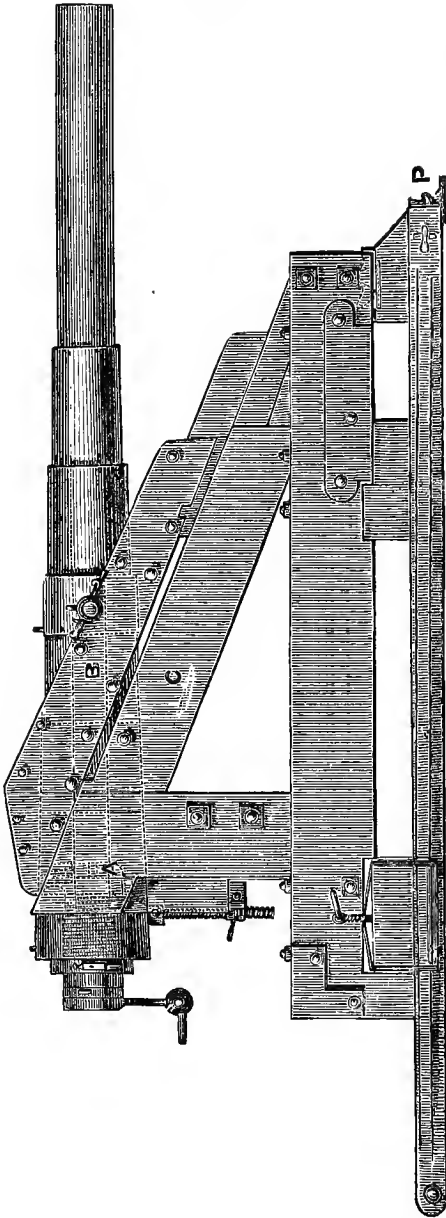
Either of the three shots would have proved fatal to the gun.

The Armstrong gun which was fired at was a 12-pounder, and was so placed as to make an angle of  $15^{\circ}$  with the line of the axis of the piece employed against it.

555. **Armstrong's Carriage for Ship's Use.** The form of carriage for use on board ship, that has been proposed to be used with this gun, is represented in fig. 147, it being considered a point of great importance that a breech-loading cannon should be self-acting in recovering its position after recoil, so as to obviate the employment of so many men to run out the gun.

556. The greatest range that has yet been attained with the Armstrong gun is 9,175 yards, or nearly five

Fig. 147.



and a half miles. The conditions which are chiefly conducive to an extended range are a small bore and a very lengthened projectile; but the more a projectile assumes the character of a bolt, the less suitable it becomes for a shell. Sir William Armstrong, therefore, deprecates any further increase of range at expense of efficiency in the shell; and, indeed, it may well be doubted whether an extension of range beyond a distance of five miles would prove of any practical utility.

The largest gun which has yet been completed upon Sir Wm. Armstrong's principle is one of 65 cwt., which, although only design-

ed to throw a projectile of 80 lbs, has been frequently tried with a shot weighing upwards of 100 lbs.

557. **Strength of the Armstrong Gun.** With regard to the strength of the Armstrong guns to resist explosion, the 12-pounders have been proved by filling the chamber with powder (about  $2\frac{1}{2}$  lbs.), and using a shot of double the service weight. In the case of the 40-pounders, it is intended to apply double charges and single shot. To provide for a large charge of powder, it is only necessary to reduce the lead on the shot, so as to allow it to enter further into the bore. Sir W. Armstrong believes the strength of his guns to be enormously in excess of these charges, the object of the proof being rather to detect defects in the surface of the bore than the resistance to bursting, which he considers to be almost uniform in all guns constructed on this principle.

The prominent feature in the manufacture of these guns, to which their great strength is due, lies in the application of the wrought iron in the form of long bars, which are coiled into spiral tubes, and then welded by forging. This plan is not original with Sir W. Armstrong, or, if original, he is not the first inventor to whom this method of giving strength to cannon has suggested itself.

558. **Treadwell's Plan for Constructing Cannon.** Professor Treadwell, of Harvard University, communicated to the American Academy of Arts and Sciences, in February, 1856, a paper "on the practicability of constructing cannon of great calibre, capable of enduring long continued use under full charges." He proposed to form a body for the gun, containing the bore and breech as

now formed, of cast iron, but with walls of only about half the thickness of the diameter of the bore; "Upon this body I place rings or hoops of wrought iron, in one, two, or more layers, every hoop is formed with a screw or thread upon its inside, to fit to a corresponding screw or thread formed upon the body of the gun first, and afterward upon each layer that is embraced by another layer. These hoops are made a little, say,  $\frac{1}{1000}$  part of their diameter, less upon their insides than the parts that they enclose. They are then expanded by heat, and being turned on to their places, suffered to cool, when they contract and compress first the body of the gun, and afterward, each successive layer all that it encloses. This compression must be made such that, when the gun is subjected to the greatest force, the body of the gun and the several layers of rings will be distended to the fracturing point at the same time, and thus all take a portion of the strain up to its bearing capacity.

"Between the years 1841 and 1845, I made upwards of twenty cannon of this material. They were all made up of rings or short hollow cylinders, welded together endwise. *Each ring was made of bars wound upon an arbor spirally*, and, being welded and shaped in dies were joined endwise when in the furnace and at a welding heat, and afterward pressed together in a mould by a hydrostatic press of 1.000 tons force. Finding in the early stage of the manufacture that the softness of the wrought iron was a serious defect, I *formed those made afterward with a lining of steel, the wrought-iron bars being wound upon a previously formed steel ring*. A 6-pdr., thus made bore 1,560 discharges, beginning with

service charges and ending with 10 charges of 6 pounds of powder and 7 shot, without essential injury. It required to destroy a 32-pdr., thus made, a succession of charges ending with 14 pounds of powder and 5 shot, although the weight of the gun was but 60 times the weight of the proper shot" (less than the proportional weight of a carronade).

559. The plan of winding the wrought-iron bars upon a steel ring is identical with the mode of constructing the first of the Armstrong guns.

Professor Treadwell screwed this ring, afterward, upon his cast-iron body, whereas Sir W. Armstrong formed the body of the gun of steel, and placed his wrought-iron rings on it. In both guns the strength desired was obtained by the same means, viz.: by disposing the wrought-iron bars in the form of tubes coiled spirally, and then welding by forging.

Professor Treadwell's plan has been before the world since 1841.

560. **The Whitworth Gun.** The method of rifling adopted by Mr. Whitworth, consists in making the bore of the gun (fig. 148) of a hexagonal spiral form, by

Fig. 148.

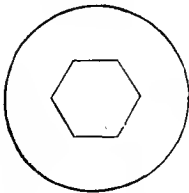


Fig. 149.



which rotation is impressed upon the projectile by effective rifling *surfaces*, instead of by spiral *grooves* and the non-effective *lands* of a cylindrical bore. The projectiles

(fig. 149) being of the same hexagonal form externally as the bore is internally, and no forcing process required, metals of all degrees of hardness may be employed.

This simple mechanical principle admits of application to fire-arms of every description, provided they are of sufficient strength to resist the strain put upon them by the rifling principle.

561. Mr. Whitworth first applied his system to rifle-muskets, and with such success as, in all the comparisons made between it and the Enfield rifle, to excel the latter in accuracy and penetration.

The great strain put upon a gun rifled in the ordinary manner, at the instant of discharge, is occasioned by the force exerted upon the projectile to overcome its natural *vis inertiae*, together with the force required to cause the soft metal of which the projectile is formed, or with which it must be coated, to enter into the grooves of the bore; whereas by the system of rifling by surfaces, and not by grooves, the projectile, not being forced into another form, is more easily set in motion.

Mr. Whitworth entirely eschews the method of giving a gaining twist to the spiral of the bore, as obviously dangerous, by causing increasing strains upon the gun, in the chase and at the muzzle, just where the diminishing thickness of metal in the gun requires relief; and to which malformation of the Lancaster gun, may be attributed the frequent burstings of that gun at or near the muzzle, which occurred in numerous experimental trials, and subsequently happened on service at the attack of Sevastopol; where, on one occasion, the whole muzzle of a gun was blown off by the increasing strains thus put on it; having got rid of which weak part, the

gun continued to be used with safety and effect as a howitzer.

562. There are three calibres of the Whitworth style of ordnance; their weights, &c., are noted in the following table.

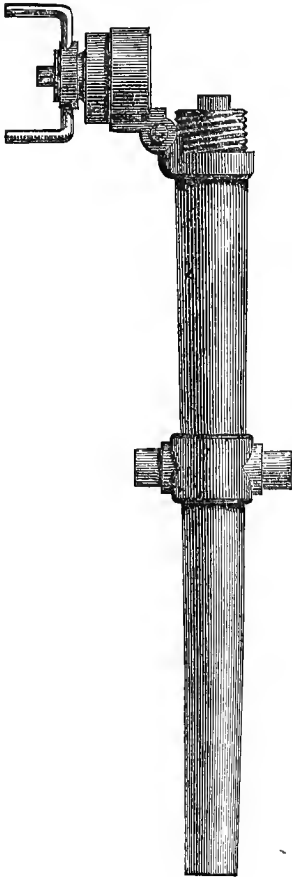
Calibre.	Weight.	Diameter of Bore.	Length.		Measure of Twist.	Charge.
			ft.	in.		
80-pdr.	4 tons.	5 inch.	9 .	10	one turn in 8 ft 4 in	12 lbs.
12 "	8 cwt.	3½ "	7 .	9	5 " 0 "	1½ "
3 "	208 lbs	1½ "	6 .	0	3 " 4 "	8 ozs.

It will be seen from the form of the ball (fig. 149), that it presents many surfaces and points calculated to interfere with its accuracy of flight through the air; it is to overcome this that such a rapid motion of rotation is communicated to the ball; an idea of the rapidity of this motion may be formed by noticing the measure of twist in the 3-pounder, the piece from which the most wonderful results have been obtained. In this piece we have one turn in 3 feet 4 inches, and as the piece itself is only 6 feet in length, the ball is required to make nearly two entire revolutions before leaving the bore; in spite of this great strain that is thus brought upon the gun, it is said to be very strong, and the 3-pounder has been fired fifteen hundred times, chiefly at high elevations, without the gun exhibiting any injury or signs of wear.

The Whitworth cannon is a breech-loading piece; the arrangement by which the breech is closed, after loading, is shown in fig. 150. This arrangement consists of a cap screwed on externally; this cap works in an iron hoop,

jointed to a projection at the side of the breech, and which, when turned to its proper place, is screwed externally to the breech piece. The shot is first put

Fig. 150.



into the gun through the breech, then the powder in a tin case fitting exactly into the hexagonal bore of the gun, having a lubricating wad attached to the fore part of it, which at each discharge sponges out the gun, the tin case remaining in the chamber; the door is then closed when the cap screw fits on to its place, and three turns of the screw handle screw it on to the piece. The vent lies in the centre of the breech piece.

The Whitworth guns are all made in masses of "homogeneous"\* iron, and bored out of the solid. The large guns are strengthened by wrought-iron hoops applied by hydraulic pressure.

563. The projectiles are simple, uncoated, hard-metal bolts of various shapes, according to the purpose for which they are

\* Since the public have become familiar with this gun, and its mode of construction, this peculiar term is found to have been used simply to conceal the fact that the gun is made of wrought-iron rings shrunk on a cast-iron body, on the same principle as the Armstrong and Treadwell plans.

employed. They are all made by self-acting machinery, and so nicely shaped that their bearing surfaces fit with the utmost exactitude, the rifling principle being executed by machinery in the workshop, and not produced by the explosion in the gun.

For firing through soft substances and into masonry, tubular projectiles are employed; for piercing thick plates of wrought iron, flat-fronted projectiles, made of homogeneous iron, are used.

For ordinary practice, and where length of range is important, the fore part of the projectile is made to taper slightly, the front being rounded off, and the rear part is made nearly to correspond with the fore, with regard to the degree of taper, but its end is flattened, and sometimes slightly hollowed out.

In the Whitworth gun projectiles of any length, and charges of powder of any amount may be employed. It is said that the Whitworth 3-pounder fired off ten shots, placed one on another; and that a projectile ten diameters in length was fired from a howitzer, rifled according to the Whitworth system, without injury to the gun.

564. The following is a table of ranges of the Whitworth guns which exhibits their capacity:

Weight of Shot.	Elevation.	Charge.	Mean Range in Yards.	Greatest range Yards.
3 lbs.	35°	8 oz.	9366	9688
" "	20°	8 oz.	6960	7073
" "	20°	7½ oz.	6551	6910
" "	10°	8 oz.	4189	4381
" "	10°	7½ oz.	4174	4224
" "	3°	8 oz.	1580	1607
12 lbs.	10°	1¾ lbs.	4027	4120
" "	5°	" "	2322	2350
" "	2°	" "	1254	1280
80 lbs.	10°	12 lbs.	4700	4730
" "	7°	" "	3490	3503
" "	5°	" "	2566	2550
" "	10°	10 lbs.	4410	4508

565. The following table compares these results with those derived from series of firings of smooth-bore ordnance in the British Navy:

Name of Gun.	Weight.	Elevation and Ranges.					Charge.
		2° yds.	3° yds.	5° yds.	10° yds.	35° yds.	
Long 32-pdr.	56 cwt.	1130	----	1964	2682	----	10 lbs.
" 24 "	50 "	1100	----	1854	2600	----	8 lbs.
" 12 "	34 "	1000	----	1520	2330	----	4 lbs.
Whitworth's 12-pdr.	8 "	1252	----	2322	4027	----	1¾ lbs.
" 3 "	2 "	----	1580	----	4189	9366	8 oz.
" 80 "	80 "	----	----	2566	4700	----	12 lbs.
Armstrong's 32-pdr.	20 "	----	----	----	----	9130	6 lbs.

566. **Advantage of Rifled Cannon limited to Long Ranges.** It will be seen from this that, at the low elevations, the range of these rifled cannon does not so much exceed that of the smooth bore guns; but it is at the higher elevation of ten degrees, that the range is nearly double. It is therefore from the power possessed by these rifled cannon of throwing shot with great accuracy to extreme long ranges, that their effect upon the attack and defence

of fortresses will be produced. This fact, that the peculiar service to which rifled cannon seem to be adapted is confined to extreme long ranges, offers an argument against their application to the batteries of ships of war, for, on ricochet, the rifle ball cannot be depended on for accuracy, the rifle motion causing it to deviate from the original direction, after the graze.

567. The results of the practice as shown by the table go to show, as has been before asserted, that, although the suppression of windage tends in a measure to increase the range, the increase is in a chief degree due to the elongated form of the shot, and to its peculiar rotary motion through the air, as, from the very slight excess of range at very low elevations, it is possible that the range at level of the rifled cannon would very little exceed that of the smooth bore, with the charges of powder with which each is respectively fired, and therefore that the initial velocity may not be much greater than with the smooth bore.

It is well known that a round shot cannot be projected from a smooth-bore gun beyond a certain distance, with any charge of powder or with any elevation; this is owing to the resistance of the air, which has been found to vary as the squares of the velocities so long as these velocities did not exceed 1,200 feet per second, but that after that velocity the resistance increased to such an extent as to neutralize the effect of increased charges of powder; now as the resistance of the air operates throughout the range, the less the range the less the resistance, so that at the range at level the momentum of the round and elongated shot of the same weight may be nearly equal, and the effects of each nearly equal.

If, therefore, the initial velocity of a 12-pounder smooth-bore gun with a charge of four pounds of powder, is nearly equal to that of a Whitworth or Armstrong rifled 12-pounder gun with a charge of one and three-quarters pounds of powder, the extraordinary ranges obtained by the latter at high elevations must be due to the shape of the shot and to the rotary motion round its long axis, the apex of which being inclined above the horizontal at the commencement of its flight tends to flatten the trajectory, thus lengthening the range.

568. **Reason of the Greater Range of the Smaller Calibre.** It may seem, at first glance, strange when we notice that the most wonderful ranges have been obtained from the 3-pounder, the gun of smallest calibre. In order to obtain great ranges, it has been hitherto necessary to employ very large guns, for the well known reason that (densities being equal and charges of powder proportional) the power of overcoming the resistance of the air, being as the cubes of the diameters, increased more rapidly than the resistance, which is as the squares of the diameters, from which we have, the larger the shot the longer the range. For instance, the diameter of a 24-lbs. shot is 5.82 inches, of the 9-lbs. shot 4.2 inches, the squares of which are respectively 33.37 and 17.64; and the cubes 197.1 and 74; the squares or area of resistance are as 2 to 1 nearly, and the cubes or momentum as 2.6 to 1, so the ranges would be to each other as 2.6 to 2.

But with the elongated shot, the case is quite different; for instance, take Whitworth's 12-lbs. shot and 3-lbs. shot; here the weight is as 4 to 1, but the 12-lbs. shot has a diameter of  $3\frac{1}{4}$  inches, and the 3-lbs. shot

only  $1\frac{1}{2}$  inches; hence the  $3\frac{1}{4}$  or 10.56 is to  $1\frac{1}{2}$  or 2.25 as 4.7 to 1; or the resistance of the air opposed to the large shot in this case is to its power of forcing its way through the air as 4.7 to 4, and therefore the small shot ought, with proportional charges, to have the longer range; and this, as regards the 12-pounder and the 3-pounder, we find to have been the case, the greatest ranges at  $10^\circ$  elevation being respectively 4,120 yards and 4,380 yards, or as 4 to 4.25; at higher elevations and with longer ranges the proportion would be still more.

569. **Comparison of the Armstrong and Whitworth Cannon.** Sir Howard Douglas, in an article on the respective capabilities of the Armstrong and Whitworth guns, came to the conclusion that, for practical purposes, the little extra range that is obtained by the Whitworth is of no advantage, as the damage that can be done at that extreme distance by a simple shot is very insignificant; he commends the method of Sir William Armstrong in limiting the range of his pieces to more practical distances, and recognizes the advantage that the Armstrong possesses over the Whitworth at these shorter ranges both from the greater diameter of the projectiles used, and from their particular adaptation to shell firing. The solitary point in which the smaller bore and longer projectile of the Whitworth is acknowledged to have the advantage, is in *boring* its way through the iron plates of such ships as the Gloire and the Warrior.

Sir Howard Douglas goes so far as to recommend that the spar-deck batteries of line-of-battle ships be composed of Armstrong guns, "mounted on revolving carriages;" but, he says, "it may be very much doubted whether, in close action, the smashing and ravaging ef-

fects and the large apertures made by spherical shot and shells, fired from a gun of 8-inch calibre on a timber ship (*for such will still be ocean fleets*), is not much greater than the effect of any elongated shot.

“It may likewise be very much doubted whether elongated rifle shot will supplant spherical projectiles of large calibre for siege and battering purposes, and for knocking down walls of masonry. Breaches are not made in the ramparts of a fortification by the penetrating power of the shot; but, after the breach has been traced out and cut through by shot fired with great charges, it is effected by concussions occasioned by the action and reaction of shot fired in volleys with reduced charges, so that the shot may not penetrate but communicate all their motion to the medium by impact.”

570. **Objections to Breech-Loading Cannon.** In spite of the apparent success of the Armstrong and Whitworth guns, there are objections to breech-loading cannon which must be pointed out, and which go to prove that the endeavor to produce breech-loading cannon is an effort to obtain uncalled for and superfluous facility in gunnery.

What superior property can it possess over the solid gun? It cannot be safety; for when we consider the very limited number of explosions by which the very best guns are destroyed, it can scarcely be possible for a gun composed of many parts to endure the intense vibrations to which large cannon are subjected. Vibration, if judiciously distributed, is the soul of endurance, but, if injudiciously distributed, is certain to result in the destruction of the cannon. In structures composed necessarily of many joints, obstructions to the

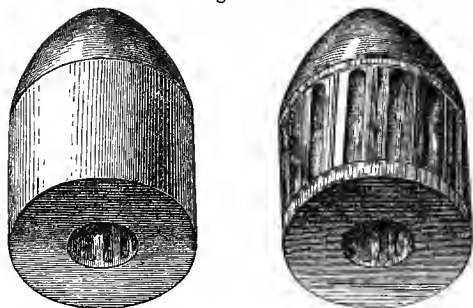
waves of vibration must occur; the different parts do not expand and vibrate equally, a kind of revulsion is induced, part repels part, and destruction ensues as a natural consequence. Under no circumstances, therefore, can a breech-loading gun be as safe as a solid gun.

The facility of loading, and rapidity with which a breech-loading piece can be fired, are spoken of as advantages of great importance, but these amount to nothing; for the gun, after every discharge, must be relayed in order to obtain accuracy of aim, and it is the pointing of a gun, and not the loading, that consumes time.

Again, the tendency of all guns to absorb the heat, developed during explosion, puts a limit to all extreme rapidity of fire. During the late Russian war, at Sweaborg, it was found necessary to allow an interval of five minutes between each discharge of a mortar, and yet the whole of them burst after an average of 120 shots.

571. **James' Rifle Shot.** The arguments against breech-loading cannon are so strong that, in this country, the design of inventors seems more particularly to be directed to the application of the rifle system to cannon loading at the muzzle. The shot that has attracted the most attention, from the extensive scale in which experiments have been carried on with it by the inventor, is the *James* shot. Many series of experiments have been carried on with this shot at Watch Hill, Connecticut, some of which, in the presence of boards of army and navy officers, were instituted for the purpose of testing its fitness for adoption into the services of the United States; but the results have not realized the anticipations of the inventor. This shot or shell is, in outward appearance, fig. 151, a cone resting on a cylinder; it has

Fig. 151.



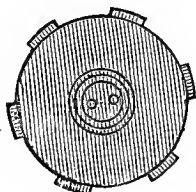
a deep cavity from the base; communication is established between the cavity and the exterior of the cylindrical portion by a number of longitudinal slits, which enable the gas, entering the cavity, to issue through them, thus blowing or forcing into the grooves of the gun, the wrapping of soft metal with which the cylinder is surrounded, and by this means imparting the required rotary motion to the ball. The ball is first wrapped with tin, then with canvas greased; between the tin and the canvas melted lead is poured. This projectile enters the bore freely, and, at the discharge of the cartridge, this collection of wrappings is blown into the grooves of the gun. Great ranges have been obtained, but it has been found that the accuracy is not equal to that of the nine-inch gun of our service; and, however formidable the projectile might prove to be after it reached the enemy, it would be found rather formidable against our own men if fired over the heads of men in attacking boats, for the wrappings of lead &c. are blown out of the bore, spreading as they issue from the muzzle, and fall in various trajectories.

572. **Sawyer's Shell.** Another American invention may be described, which is probably the best of its

class, and may be cited as a specimen of many others constructed on the same principle. It is the invention of Mr. *Sawyer*.

Any gun, now in service, can be taken and reamed out with six grooves, to correspond to six projections on the shell, the measure of the twist being one turn in about 30 feet. The shell, called for its inventor, the "Sawyer shell," is of cast iron, in form a cone resting on a cylinder, the lower edge of which is slightly chamfered; the iron projectile is coated with tin; there are then cast upon the cylindrical portion of it six projections

Fig. 152.



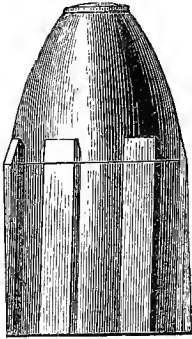
(fig. 152), to fit the grooves in the gun, and set at an angle to coincide with the rifling in the bore. These projections are made of a composition of lead and tin, and the same composition forms the base of the projectile which extends about an eighth of an inch below

the cast-iron cylinder of the shell, as originally cast. The base of the projectile is a plane surface.

This projectile is easily entered in the bore and pushed home; when the discharge takes place the composition at the base of the projectile is flattened out by being forced forward against the harder substance of the iron shell, the iron cylinder being chamfered at the base assists this flattening out of the softer metal; windage is thus suppressed, and the projectile, taking up motion in obedience to the impulse of the charge, takes up a rotary motion around its longer axis in obedience to the twist in the bore operating through the projections on the cylindrical portion of the projectile. These projections extend along the *entire cylindrical por-*

tion of the projectile, and thus give great *steadiness* to the motion of rotation; this fact is worthy of note, inasmuch as it is an objection urged against some shells, where the rifle motion is communicated at the *extremity* of the shell, that, in their flight, they describe a spiral around their general line of direction.

Fig. 153.



The Sawyer shell (fig. 153), is a percussion shell, the mechanism being of the simplest possible nature. At the apex of the shell a hole, in the direction of the axis, communicates with the interior cavity of the shell; this fuze-hole is tapped near the outer surface of the shell for the purpose of receiving a brass cap which rests on the edge of it; the fuze-hole as it approaches the chamber for the bursting charge, is suddenly contracted forming a cylinder of reduced diameter, this cylindrical passage is also tapped, and into it is screwed a pin or bolt, the lower surface of which is flush with the interior surface of the shell, while its head extends through the fuze-hole until it reaches nearly to the outer surface of the shell. The fulminate is placed in the concave portion of the cap (the outer surface of the cap being slightly convex), and, when the cap is screwed in, the fulminate is just clear of the head of the rigid pin which is supported in its place by being screwed into the lower cylindrical passage. The flame is generated by the impact of the point against any hard substance, as, on impact, the cap is flattened in and the fulminate is brought in violent contact with the head of the pin; the flame is allowed to penetrate into the shell, and to com-

municate with the bursting charge, by means of two holes which perforate the pin longitudinally.

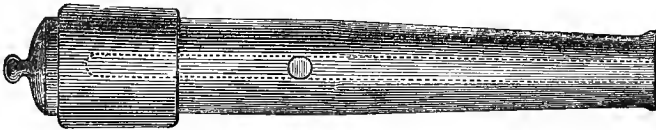
The accuracy and range with this shell have been very satisfactory, and a single instance of its great power will be sufficient to cite. A target composed of four layers of oak timber, each layer being one foot thick, and securely bolted together, was fired at at the distance of 600 yards; the shell penetrated three feet of the target before bursting; on bursting, the fourth timber was broken into pieces, many of them being thrown 40 and 50 feet to the rear of the target. The tearing effect of the rifle motion of the ball was distinctly apparent in the fibres of the wood. It has been argued against percussion shells that, if they fulfil their mission, their effect must be superficial, but this simple application of the percussive system allows the shell to penetrate to great depths before exploding, as was apparent in the experiment just cited. So admirably does the percussive system work in this shell that the inventor anticipates from it great effect against masonry; for the purpose of testing this, experiments have been carried on, and the results, so far as they have yet transpired, go to prove that this shell possesses power likely to make it very formidable against fortified places. The shells can be made for any calibre of gun, the one with which experiments have been chiefly made weighed 42 lbs., and was fired from a 24-pounder, rifled to fit the projections on the shell.

573. **The Parrott Gun.** This rifled cannon is the invention of Mr. R. P. Parrott, of the celebrated West Point foundry. Ever since the first appearance of the gun, and the first experiments made with it, it has been growing

in favor, and it bids fair now to supplant all previous inventions in the line of rifled cannon.

The cannon proper is a cast-iron piece of very light proportions, rifled with five grooves, the circumference of the bore being equally divided between the lands and grooves. The distinctive characteristic of the gun consists in the reinforce, which is a wrought-iron ring, or hollow cylinder, shrunk around the breech at the seat of the charge. This ring is only just long enough to cover the space occupied by the charge of powder and the projectile, the inventor believing that a decided advantage is gained by making the reinforce no longer than is absolutely necessary to strengthen the gun at this place.

Fig. 154.



An ingenious application of the Rodman principle of casting (as described in an earlier portion of this work) is practised in the shrinking on the reinforce ring. When the ring is to be adjusted it is heated and placed around the breech in its proper position, the gun being laid nearly horizontally with its axis slightly depressed; a stream of cold water is forced into the bore, which runs out freely owing to the depression of the muzzle, thus keeping the bore supplied with a constant stream of cold water; as the influence of the cold is felt upon the iron, the wrought-iron ring is forced to cool from the interior, which, setting first, draws around it the more liquid outer layers; the entire ring thus cools in

the order best calculated to produce strength. The thickness of the ring is equal to half the diameter of the bore.

Three calibres have been introduced into the service, viz.: 10, 20, and 30 pounders. The following table shows the dimensions, &c., of these guns:

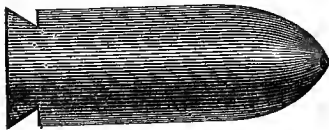
Calibre.	Length.	Weight.	Diameter of Bore.	Charge.	Twist.
10 pdr.		900 lbs.		1 lb.	1 turn in 10 feet.
20 "	94 in.	1650 "	3.67 in.	2 "	" " " " "
30 "	126 "	3400 "	4.20 "	3 $\frac{1}{4}$ "	" " " 12 "

The range of the 30-pdr. at 15° elevation is 4,800 yards, which is 100 yards greater than that of the Armstrong gun at the same elevation.

A 100-pounder is in process of construction which, with a bore of about 6 inches, will weigh 9,000 lbs. and be fired with a charge of from 8 to 10 lbs.

574. **The Parrott Shell.** The projectile used with the Parrott gun is an elongated shell of a length equal to three calibres. It is cylindro-conical in form, the cylinder being very long; the shell is cast with its base as represented in fig. 155, a brass ring is afterward fitted around

Fig. 155.



the contraction of the base, making it cylindrical. The gas, entering between the iron and the brass, forces the latter into the grooves by which the

rotary motion is communicated to the projectile. The ring is prevented from stripping off the shell by having the two surfaces in contact corrugated, and by some projections on the upper edge of the ring which are jogged into the metal of the shell.

Some of the shells are fitted with a percussion arrangement for exploding on impact. The arrangement is a simple plunger primed with a percussion cap, which, on impact, is driven against the metal head and exploded. Some of the shells, however, are fitted with the ordinary paper time-fuze, which never fails to explode the shell, thus proving that, notwithstanding the suppression of windage, enough flame escapes past the projectile to ignite a fuze.

Great accuracy has been obtained with this gun and projectile, and already a large number of this class of ordnance have been adopted into U. S. field batteries and naval armaments.

A monster rifled cannon of 16,000 lbs. weight, and said to throw a shell of 150 lbs., is in process of construction, invented by Commander J. A. Dahlgren. This gun is cast without trunnions, which are to be strapped on. The increase of strength consequent on dispensing with the trunnions has been explained in chapter III.

The shell prepared for this cannon is cylindro-conical in form, and made of cast iron with a leaden base; projections to fit the grooves are cast on the front or iron portion of the cylinder, while around the cylinder midway of the leaden base is cut out a score in which is wrapped a greased patch, which serves to lubricate the bore.

This gun and projectile are intended to supersede the eleven-inch gun in the armaments of the new gunboats, lately constructed and rapidly fitting for service.

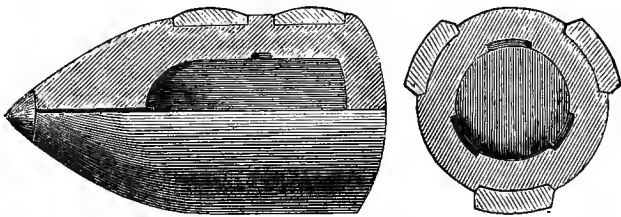
575. **The Blakely Gun.** This gun, which enjoys at present considerable reputation in Europe, is essentially of the same construction as the Armstrong and Whit-

worth guns; that is, it is built up of wrought-iron rings or hoops shrunk around a cast-iron core. It is constructed to load at the muzzle, thereby securing greater strength, and dispensing with all the questionable advantages claimed for breech-loading cannon.

A commission appointed by the Spanish government has lately made an extended series of experiments on the gun, comparing it with a cast-iron rifled piece; and, from the results of their experiments, has recommended its adoption into the Spanish service, and that government has ordered 600 sixty-pounders to be constructed.

The shell used in the Spanish service in connection with this piece is represented in fig. 156, and is of cast iron, with six buttons of zinc arranged in two rows around the cylindrical part of the ball; these enter the grooves in the bore and give the rotary motion to the projectile.

Fig. 156.



It will be observed that these three guns, the Armstrong, the Whitworth, and the Blakely,\* all derive their great strength from the method of shrinking wrought-iron hoops or rings around a cast-iron body or core; and it is but justice to a countryman to draw attention to the close similarity that these methods of construc-

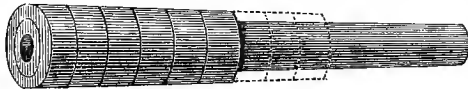
\* Captain Blakely's investigations were, no doubt, original, as he commenced them before any thing on this particular form of gun was published in Europe.

tion bear to that invented by Professor Daniel Treadwell in 1841. The three methods are in fact one, and identical with that of Professor Treadwell, and it is hardly possible to suppose that the *new inventors* of the system were ignorant of the fact of a previous discovery.

576. **Babcock's Mode of Constructing Cannon.** Mr. J. C. Babcock, of Chicago, suggests another way of arranging the metal for the spirals, wrapped around the cast-iron core, founded on the different expansive properties of metals.

He recommends that the core be of cast-iron; on this shrink a layer of wrought iron rings as shown in fig. 157

Fig. 157.



these, with the cylinder, should form about one half of the thickness of the gun. Bands of steel, fig. 158, should

Fig. 158.

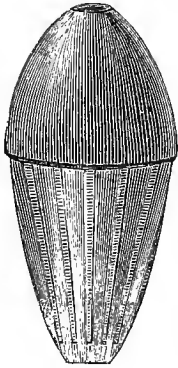


now be wound spirally in alternate layers to the required thickness, reversing the winding of each layer, so as to break joints.

The arrangement of the materials in the order of their expansive properties gives more work to the exterior of the gun, for cast iron is doubly more expansive than wrought iron, and wrought iron even doubly more expansive than steel. All parts of the wall of the gun

would thus bear a strain at the same time, and there could be no bursting by successive layers, as has been shown, in an earlier portion of this work, is the case with a cast-iron gun where the expansive capacity of the wall is constant throughout the entire thickness.

Fig. 159.



577. **The Schenkl Rifle Shell.** Another late invention in the shells for rifled cannon is the Schenkl shell, named from its inventor, a drawing of which is given in fig. 159.

The greatest diameter is a little more than one-third of its length from the forward end, from which place to the rear end it presents the form of a truncated cone. The surface of this conical part is furrowed with straight grooves.

Around the rear portion of the shell is placed a wrapping or patchin of papier-maché, the interior of which is formed as a truncated cone, to fit around the shell, and the exterior is cylindrical. When adjusted in its place the projectile presents the appearance represented in fig. 160.

Fig. 160.

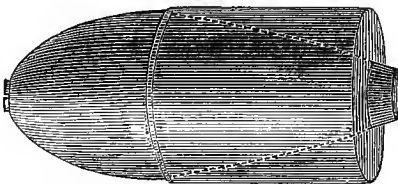


Fig. 161.



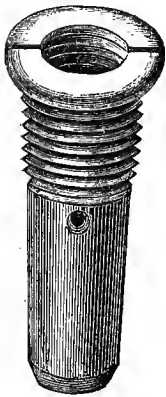
Fig. 161, represents a section of the patch of papier-maché.

When the charge in the gun is ignited, the gas mashes out the patchin, being assisted by the straight grooves on the shell, causing it to fill the grooves of the bore, thus imparting the rifle motion to the projectile.

Fig. 162. The fuze composition is driven in a steel cylinder represented in fig. 162, which has a small screw hole entering a short distance into one side; the forward end of this cylinder is terminated by a nipple, which, in a cylindrical recess, projects slightly beyond the face of the cylinder. This cylinder is placed inside of



Fig 163.



the fuze-case fig. 163, in which it fits loosely, and is suspended in it by a small screw which passes through a hole in the side of the fuze case and steel cylinder. A common percussion cap is placed upon the nipple, and a brass cap, fig. 164,



Fig. 164.

164, is then screwed into the fuze case. When the gun is fired, the small screw, which supports the steel cylinder, is broken, and the cylinder (like the plunger in most percussion arrangements) recedes to the bottom of the fuze case. When the shell strikes the object, the plunger moves forward with violence, and striking the percussion cap against the brass cap, explodes the former, thereby communicating flame to the composition of the fuze.

As a precaution against the danger of explosion while handling, the brass cap is counter-sunk on the top, and it can be screwed into the fuze case with the top side down. This is the position in which the brass cap is

required to be kept at all times, except when loading. While the counter-sunk side is down, should the plunger become loose, the percussion cap is prevented from coming in contact with the hard surface of the brass cap, but on being turned end for end, a plane surface is opposed to the percussion cap, which is exploded by the impact.

The slits, cut in the top of the fuze case and the brass cap, are designed for the entrance of the fuze wrenches, when it is desired to unscrew the fuze case from the shell, or to unscrew the cap in order to turn it end for end.

578. **Initial Velocity of Rifle Projectiles.** The initial velocity of projectiles fired from smooth-bored cannon has been fixed at 1,600 feet per second, or about that at which air rushes into a vacuum, this being the greatest velocity that can, with advantage, be impressed upon the projectile. In order to obtain this velocity it has been found that a charge of one-fourth or one-third the weight of the projectile was necessary.

Rifled cannon are fired with reduced charges, and, as a consequence, the initial velocity of the projectiles is less than that of those fired from the smooth-bored guns. The striking velocity of the rifle projectile will thus be less than it might be were a higher initial velocity imparted to it; and in view of the effort to solve the problem of cuirassing ships of war, this question is important, involving as it does the power of penetration.

With rifled cannon made of cast iron, the tenacity of the metal is not sufficient to bear the force of charges of powder greater than those now in use; these charges are from one-tenth to one-twelfth. If the velocity of

1,600 feet per second be found to be indispensably necessary, it is evident that cast iron can no longer be of service for these guns, and that a metal of greater tenacity must be substituted. This will necessarily lead to the adoption of Treadwell's plan of construction of wrought-iron rings around a core or body of cast iron, or of Babcock's, where the wrought-iron bands are in their turn surrounded by spirals of steel.

Should the rapid strides being made at this time in rifled ordnance lead to any new developments on this point, so as to make it necessary to obtain the highest initial velocity by changing the metal and increasing the charge, it will become a consideration, in armaments for ships, how to control the recoil of these guns of light proportional weight, and the ingenuity of artillerists and machinists will have to be brought to bear on this subject.

Inventions in this direction have not been encouraged, the argument having been always that the weight of the guns sufficiently controlled the recoil; but if we change the metal, and can obtain as good results with lighter guns, it will be desirable to adopt them, in order to free the ship of so much weight on deck; and the weight of the gun now not being sufficient to control the recoil, the field would seem to be thrown open for the invention of means to control the recoil.

579. **Plan of Controlling the Recoil.** Professor Treadwell proposed, in 1845, a plan for controlling the recoil of his light guns, which seems to offer a very fair prospect of success if fitted to the navy four-truck carriage. His apparatus consisted essentially of a shaft passing through the carriage directly under the gun. From this

shaft he passed to the side of the ship, or any permanent object, a large, flat band of ropes, bound together. Upon one end of the shaft, outside of the gun-carriage, but covered over by a box, he fixed several small plates or disks. Other stationary plates or disks were placed between these, and the whole were pressed together by a spring. The opposite end of the shaft had a wheel on which was wound a common rope. Now, when the friction springs are open, if the last named rope be drawn so as to turn the shaft, the flat band is wound upon it as the gun is run out. Then, by the movement of a lever, the springs are suffered to press the plates or disks laterally against each other, and in this condition the shaft revolves with difficulty, the band not being able to unwind without overcoming the friction of all the plates which rub each other. This friction might be increased to any amount, either by increasing the force of the springs, or the number of the plates or disks.

## CHAPTER XI.

## PRACTICE OF GUNNERY.

580. **Double Shotting.** When it is intended to double-shot a gun, it should be loaded with a reduced charge: say the charge for *ordinary firing* if the gun be cool; and the charge for *near firing* if the gun be hot.

In practice with two shot, there are causes of irregularity which show how little it can be depended upon, excepting in close action. Besides a difference of range, frequently amounting to above a hundred yards, there is also a divergence, which, in firing at ships at long ranges, or at any objects whose magnitudes are not sufficient to subtend the horizontal divergence of the balls, incurs a considerable risk of missing entirely, and a certainty of not hitting with both. If the balls touch each other on leaving the gun, some deviation must arise, according to the nature of the collision. If it be direct, one ball will be accelerated, and the other retarded, by the blow. But this will rarely happen; it is more likely that the blow will be oblique, from which both balls will diverge very considerably, in directions compounded of the projectile velocity, and the force and direction of the collision. This deviating cause may either operate in a lateral or in a vertical direction; in the former case it will affect the line, in the latter case the inclination of the shot's departure, and consequently the length of

range; or the error may exist in both directions. It is evident that this deviating cause will be the greater, the greater the windage: for the shot nearest to the charge impelling the other, will be forced to one side of the cylinder, pressing the outward ball to the other side of the bore; from this it is manifest that the outward ball must receive an oblique impetus on its departure from the muzzle, which will disturb, from reaction, the direction of the other. It is found, from all experiments, that the ball which was in contact with the charge had the least velocity and the least penetrating power.

**581. Distance at which Double Shotting is Available.** Good effect with two shot cannot be expected at distances greater than 300 or 350 yards, and it should not be practiced from guns having less proportional weight than 130 lbs. of metal to 1 of shot, and then great care must be taken to see that none but reduced charges are used.

**582. Advantage of Double Shotting Questionable.** It may be questioned whether there is any advantage to be derived from double shotting under any circumstances; the increased strain brought upon the gun, the breeching, and the bolts, and the danger, in the excitement of action, of loading with the *distant firing* charge instead of a reduced charge, argue strongly against the questionable advantage of delivering more missiles in a certain space of time. The single projectile, even at close quarters, can be delivered with certainty at a vulnerable point, while the two shot having no accuracy are fired at random and strike where chance may direct. Another objection is the longer time required to load with two shot, and the tendency that all reduced charges have not to remain under the vent, thus rendering it impossi-

ble to discharge the piece until it shall have been rammed well home.

583. **Round Shot and Stand of Grape.** With double loadings of round shot and grape, when the shot is put in first, the projectiles range more together than when the reverse process is used. It was ascertained from experiments made at Gavre in 1838, that when the grape was in contact with the charge, the dispersion of the balls was twice as great as when the round shot was in such contact.

584. **Effect of Shot on Iron.** From the experiments made at Metz in 1834, it appears that masses of cast iron above 1 yard square and 13 inches thick, do not resist the shock of balls fired against them with even moderate velocities, having been fractured not only at the point of contact, but also at points considerably distant from thence.

In August 1840, experiments were made at Woolwich, in order to determine the effects of shot upon an iron target lined with a composition of caoutchouc and cork. The thickness of the iron was  $\frac{5}{8}$  inch, and of the composition 9 inches. The result of the trial was that it was concluded that no advantage would be gained by thus lining or covering the sides of an iron vessel.

The effect of shot upon an iron hull was remarkably exemplified on H. B. M. Steamer "Lizard" during the operations that took place in the Parana in 1846, when it was found that, on being struck, the plates of the ship bulged, and the perforations were so irregular and jagged that, for the purpose of stopping them, the common shot-plugs were quite useless. This circumstance suggested the expedient of employing what has been called a *parasol plug*, which consists of an iron bolt fur-

nished with arms of the same metal and covered with thick canvas well tarred. On being thrust through the shot hole from the inside, and then forcibly drawn back, the head expanded, and thus, the aperture being covered, the leak was closed. In consequence, also, of the ship being struck, the splinters and rivets detached by the shot, flew about like grape, and nearly all the men killed and wounded suffered from this cause. Grape shot fired at a distance of 200 yards pierced the side; and persons present, who were highly capable of judging, concurred in opinion that a 32-lb. shot would have gone through the sides of three or four iron steamers, doing damage which would be successively greater in those more remote from the ship first struck, till the force was spent.

Experiments were made in 1850 against two sections of H. B. M. steamer "Simoon," her iron sides being five-eighths of an inch thick, placed thirty-five feet apart; the guns and charges were those used in all steam vessels. The result was that two or three shot, or sometimes even a single one striking near the water line of an iron vessel, must endanger the ship.

585. **Shot Breaks on Striking.** Another most serious evil is that *the shot breaks, on striking, into innumerable pieces*, which pass into the ship with such force as to range afterward to a considerable distance; hence the effect on men at their quarters would be more destructive than canister shot, supposing them to pass through a ship's side. The officer under whose direction these experiments were made states, that out of seventeen 32-lbs. shot which struck the iron butts at the distance of 450 yards, with charges varying from  $2\frac{1}{2}$  lbs. to 10

lbs., sixteen were shivered to pieces in passing through the first side, and became a cloud of langrage too numerous to be counted.

Further experiments were made on a similar section filled in and made solid, with  $5\frac{1}{2}$ -inch oak timber between the iron ribs, and  $4\frac{1}{2}$ -inch oak planking above the water-ways, which were one foot thick, and with three-inch fir above the port sills; these were strongly secured to the iron plates by bolts. The results were as follows:

The holes made by the shot were not so irregular as on the former occasion, but as clear and open. All parts of the shot passed right through the iron and timber, and then split and spread abroad with considerable velocity; parts of the iron plates, and a few very small pieces of shot, were sometimes retained in the timber. With low charges, the shot did not split into as many pieces as before. With high charges the splinters from the shot were as numerous and severe as before, with the addition of the evil to which other vessels are subject, that of the splinters torn from the timbers.

586. **Diminished Thickness in Order to Prevent the Shot from Breaking.** The thickness of the iron plates was varied, and it was determined that four-eighths of an inch is the extreme thickness of iron which should be employed in constructing iron vessels, in order to prevent the breaking of the shot. The shot, on passing through the four-eighth plate iron, made clear, clean holes of their own diameters, without rending the iron further, but the disk struck out was invariably broken into numerous pieces.

Thus it appears that the destructive effects of the im-

pact of shot on iron cannot be prevented. If the iron sides are of the thickness required to give adequate strength to the ship, five-eighths of an inch, the shot will be broken by the impact; if the iron plates be thin enough to let the shot pass through into the ship without breaking, the vessel will be deficient in strength, the shot will do its own work instead of its splinters, and in passing out, will make apertures more difficult to plug or stop than in passing in. When a clean hole is made by a shot penetrating an iron plate, the whole of the disk struck out by the shot is broken into numerous small pieces, which are driven into the ship with very destructive effects; and if the plate be so thick as to cause the shot to break on striking, the fragments will nevertheless pass into the ship and so produce a compound effect by the fragments of both.

587. **Iron Vessels Unfit for War Purposes.** From what has been stated, it is evident that iron vessels, however convenient and advantageous in other respects, are utterly unfit for purposes of war.

588. **Iron-Cased Ships.** The project of covering wooden ships with iron plates, in order to render them proof against artillery, was suggested, many years since (1821) by Colonel, the late General Paixhans. An inquiry, however, into the practicability of this method of protecting ships from the effect of shot and shells led to no attempt in France to *cuirasse* ships of war, and the project was at that time abandoned.

A proposal for constructing floating batteries of iron, so thick as to be shot proof, was entertained by the government of the United States, in or before the year 1852, and the feasibility of the proposition was made

the object of an experiment: the result of this being unfavorable, the project fell to the ground.

The idea of cuirassing ships of war was reproduced in France in 1854, by the present Emperor of the French, Napoleon III., who then proposed the construction of floating-batteries, or ships protected on the exterior by thick plates of iron. The primary object of these vessels was that they were to be employed in the attack of maritime fortresses, and thus to establish an equilibrium between land and sea batteries; but, the idea having taken root, it was thought possible that large ships, cased in armor, could be effectively used on the high seas, and we now see "La Gloire" and the "Warrior," flying the respective flags of France and England, attempting to assume positions as cruisers on the ocean.

589. **Experiments in England.** As this subject attracted much attention both in England and France, as involving the very important point of lessening the vulnerability of ships, while, as the friends of the system asserted, their efficiency as cruisers would not be much impaired, Sir Howard Douglas, in that thorough manner in which he handles all subjects that he takes up for consideration, has entered into a most elaborate investigation of the advantages and disadvantages entailed by the system, and has come to most positive conclusions on the subject, founded upon a careful analysis of all the practical evidence that could be collected from every source.

Among other experiments cited, he gives one made at Portsmouth in 1854, to try the capability of wrought-iron slabs  $4\frac{1}{2}$  inches thick to resist the impacts of solid and hollow shot against a target representing a section of a frigate covered with iron plates of that thickness. The

guns employed were 32-pdr. and 68-pdr. solid-shot guns, and 8-inch and 10-inch shell-guns firing hollow shot. At 400 yards, the 32-lbs. solid shot, and the 8-inch and 10-inch hollow shot, merely indented the target to the depths respectively of  $1\frac{1}{2}$ , 1, and  $2\frac{1}{2}$  inches; but the 68-lbs. solid shot, being fired with 16 lbs. of powder, penetrated the plates. These were always split at the bolt holes, which were about 1 foot asunder; and, in consequence, it was recommended that they should be bored as far apart as possible. The conclusion drawn from the experiments was, that  $4\frac{1}{2}$ -inch iron plates, applied as a covering to ships, would give protection, during an action, against 8-inch and 10-inch hollow shot, and against 32-lbs. solid shot, but very little against solid shot of 68 lbs.

590. **Experiments in the United States.** Experiments carried on in the United States go to show that a thickness of the plates of 6 inches is the least that would render a ship invulnerable; the conclusion then is that, although plates  $4\frac{1}{2}$  inches thick, if well backed up with masses of solid timber, may for a time resist the penetration of shot fired at considerable distances, yet that a vessel cannot be rendered invulnerable to shot by iron plates less than 6 inches thick, a weight which no vessel can carry without great sacrifice of speed, great instability, and incapability for open sea and ocean service.

591. **Jones' Inclined Sides.** The penetration of a shot into any substance depends very much upon the manner in which the object is presented to the impact; in the experiments referred to above, the sides of the targets were upright. Mr. Josiah Jones, of England, obtained a patent for constructing vessels whose sides above the

water line should slope inwards at an angle of  $45^\circ$ , so that a shot fired horizontally at a vessel's side, by striking obliquely, may not penetrate, though if upright the shot would pass through. Mr. Jones' patent consists in applying steel and iron plates  $3\frac{1}{2}$  and  $4\frac{1}{2}$  inches thick respectively, in combination with frames of timber, to a ship constructed with inclined sides; the ship being formed with an angular bend or projection in an outward direction at the line of flotation, so that a shot will glance off either upwards or downwards, according as she may be struck above or below the line of flotation.

In a vessel constructed in this manner, the deck, from the sides falling in so much, must be very much cramped, and there would be much difficulty in getting the muzzles of the guns beyond the port-sills. The deck, in fact, would be incapable of receiving and working its guns. Such a side as this could not be applied to the bottoms of the ships now in existence, and therefore new bottoms of the necessary width at the water line would have to be provided at enormous cost. Some idea of the cost of ships on Jones' principle may be formed from the fact that the cost of the side angulated plates would be from \$180 to \$200 per ton, to be added to the expense of forming the body of the ship.

Experiments were made against a target, representing such a side, with a 68-pounder at 200 yards. The result was that the shot, on striking, broke into numerous fragments; these were deflected up the inclined plane over the ship and fell into the sea at the distance of 200 yards. The sides were not penetrated, but the force with which the fragments were deflected up the inclined plane in a cone of splinters proves that such a

vessel could have no masts; for masts, spars, sails and rigging would inevitably be destroyed.

A vessel of this form is evidently unfit for sea purposes, she must be very deficient in stability and bearing. Her bearing is at the water line diminishing instead of increasing in proportion as she rolls, which is just the reverse of the case from which stability is derived; as, when the bearing or extreme breadth is above the water line, the vessel displaces with her bilge more weight of water by the side which rolls in than she takes out of the water by the bilge which rolls out.

592. **Coles' Revolving Towers.** Captain Coles of H. B. M. Navy proposes to remedy some of the defects pointed out as growing out of the angulated sides, by withdrawing the armament from the gun-deck, and installing two guns in round towers formed of strong timbers covered with  $4\frac{1}{2}$  inch iron plates; and placing seven or nine of these towers on the upper very narrow deck, each tower erected on a base which is made to turn upon its centre. The weight of one of these towers, including guns, would be about 68 tons; and Captain Coles proposes that there should be nine of these towers in one of his ships, the total weight of which would be 612 tons top weight, in addition to the weight of iron in the angulated side, and to that of the upright iron sides which he proposes, consisting of thin iron plates of sufficient thickness to resist the stroke of a sea and prevent the water from rushing up the angulated side. Sir Howard Douglas adds that such a vessel could scarcely swim upright, and pronounces the whole scheme a failure.

593. **"La Gloire."** The body of "La Gloire" is said to have been modelled on the lines of the "Napoleon,"

of 91 guns and of equal displacement, although "La Gloire" carries guns on but one deck. A much greater weight is put upon her than upon the "Napoleon;" the armament of this vessel amounted to 4,438 cwt.; the armament of "La Gloire" consists of thirty-six 50-pounders of 91 cwt. amounting to 3,276 cwt. This, together with 820 tons of  $4\frac{1}{2}$  inch iron plates, is a weight far greater than the armament of even a ship-of-the-line of three decks; but "La Gloire," being a corvette carrying 36 guns, is of much greater length than the "Napoleon," and hence the great amount of armor that she requires.

594. **"La Gloire" a Failure.** Sir Howard Douglas asserts that "La Gloire" is a failure; "that she is overloaded with armor and armament; that in any thing like heavy seas she not only takes water into her ports, but that the sea rolls over her sides and over her; that she pitches very heavily in a head swell from want of buoyancy to ride over it, as might be expected from being heavily loaded with armor at the bow and stern, where the weight is not supported by displacement directly under it, but mainly by longitudinal strength; that her speed has never realized anything like that which was expected, for that, instead of being  $13\frac{1}{2}$  knots, it has never much exceeded 11, although in her experimental trips she has not had upon her all the weight that would be required for service, excepting coals, of which she can only stow sufficient for seven days' steaming; that she could not fight her main-deck guns in a sea in which a first class frigate would be comparatively at rest; and that therefore "La Gloire" is a very bad gunnery ship, her rolling motion being great and quick, so as in a great degree to vitiate the precision of her

rified guns. When launched and fitted for sea, it was found that she did not carry her guns quite six feet above the water, and she was very deficient in stability."

595. "**La Gloire**" Deficient in Stability. "Her deficiency in stability is demonstrable. Those who are conversant with the principles upon which the equilibrium of a floating body depends, know that in a position of equilibrium the pressure of the body downwards, that is, its weight supposed to be applied at the centre of gravity of the ship, is equal to the pressure of the fluid upwards, supposed to be applied at the meta-centre; and that the nearer the meta-centre approaches to the centre of gravity of the fluid displaced, the greater the instability of the ship from defect of pressure of the fluid upwards to restore the equilibrium which any alteration in the position of the vessel had disturbed. In proportion as the meta-centre approaches the centre of gravity, the equilibrium, which is stable when the meta-centre is above the centre of gravity, becomes unstable or indifferent when the meta-centre and the centre of gravity coincide, as when the floating body is a cylinder; and when the meta-centre is below the centre of gravity the ship will upset.

"On the above principles it is clear that in *La Gloire*, burdened with the weight of her armor of 820 tons, the meta-centre must be so near the centre of gravity as to deprive her of much of the stability which a good sea-going ship must possess."

596. "**The Warrior**." This gigantic frigate constructed by the English government is thus described by Sir Howard Douglas. "The dimensions are, length

380 feet, breadth 58 feet, tonnage 6,177, her two engines of 1,200 horse power, which, with the boilers, will make a total weight of 9050 tons. She has no external keel, but an inner keelson formed of immense slabs of wrought iron; the main deck is formed of iron cased with wood; the upper deck is also so formed. The beams are of wrought iron of immense strength; the skin of the ship is formed of wrought iron  $1\frac{1}{4}$  inches thick. From 5 feet below the water-line up to the upper deck, the sides are formed of a double casing of teak, 18 inches thick. Over these the plates of iron are placed, so that the broadsides of the vessel consist of 20 inches thick of solid teak and 5 inches within and without of the very finest wrought iron. The vessel is subdivided into many portions by water-tight bulkheads. As this vessel is intended to act as a ram, the nose or cutwater is formed of one immense slab of wrought iron, 30 feet long, 10 inches thick, and weighing about 18 tons. Notwithstanding the vast displacement of the "Warrior," she can only carry coal sufficient for nine day's steaming; she must therefore be provided with full sailing power.

"The armament of the Warrior on the main deck is to consist of 36 guns, 15 on each broadside, and 6 revolving guns, all to be Armstrong's long-range guns, for shot of 100 lbs.\* Some of the plates intended to cover the sides of the Warrior, were subjected to severe tests, by firing 68-lbs. solid shot at them at the distance of 200 yards; but it was found there, as elsewhere, that slabs of iron, of any practicable thickness,

\* The last accounts state that it has been concluded to substitute on the gun-deck, for Armstrong's guns, 68-pdrs. smooth bore.

are quite insufficient to resist concentrated fire of 68-lbs. shot at short ranges, the plates having been broken and torn apart; what the effect of such a battery will be when the plates are backed up by masses of teak as described, remains to be seen.

“It may safely be pronounced that the rolling motion of this monstrous flat-bottomed vessel, burdened with so much top weight, will in any swell be destructive of good gunnery, and render abortive the accuracy of the new long-range rifled guns with which she is to be armed, and in the use of which the greatest precision and the nicest instruments in laying the gun are required. By dynamics, the times of the vibration of floating bodies vary with the depth of the vertical section below the plane of flotation; and nothing but a very deep false keel can counteract the tendency of these vessels to follow all the undulations of an agitated fluid. But, to give them false keels would add to their draught of water, and thus prevent their being employed in shallow water. The rolling motion will be far greater even than the undulations of an agitated sea would produce; for the pendulous swing of the top-heavy floating body would not be stopped and reversed until her motion, by its momentum, had rolled her side deeper into the fluid than what mere undulation of the sea would occasion, before the displacement on the rolling side had become such as to raise that side, and then she would roll equally deep the other way.”

The opinion of this great authority evidently is, that there is not much to be feared from these iron-clad monsters.

597. **Determining Distances of Objects at Sea.** In all

cases of gunnery an accurate knowledge of the distance is of the first importance. When considerable, it is usually estimated very vaguely; but the necessity of knowing it as correctly as possible, at long ranges, is greater than when the trajectory is nearly rectilinear, as in short ranges; elevation being given according to the distance, and inaccuracy increasing with length of range. At considerable distances, also, there is more leisure and opportunity as well as greater necessity, for determining those distances with precision, while in closer action all that is required is to be certain that the enemy is within the range at level.

When two vessels are opposed to each other at great distances, the effect will depend almost wholly on the skill of the gunner; and that vessel which has most correctly estimated its distance from its opponent will do most execution, supposing other things to be equal.

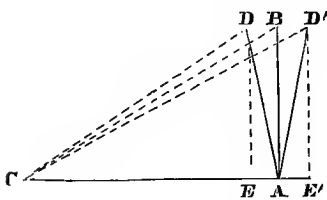
598. **Angle Subtended by the Mast of the Enemy.** Numerous methods have been proposed for readily estimating distances, and, of these, none appears more simple and obvious than the making use of the different angles subtended, at different distances, by the heights (when known), of the masts of the ship whose distance is desired, the heights and distances being arranged in a table; so that by simply measuring, with a sextant, the angular height of a mast (as is commonly done in chasing to ascertain whether the chase be gaining or losing distance), and entering the column of angles, the corresponding distance may be taken out. Tables are inserted in the "Ordnance Instructions," Appendix B, Nos. V. and VI., in which the distances corresponding to different angles subtended by the masts of English and French ships

of war are shown, from which the intermediate distances due to other angles may be estimated, and the sights regulated accordingly if circumstances should require it.

599. **Horizontal Angles taken at Bow and Stern.** Another method which has been recommended, consists in taking simultaneously, at the bow and stern of the ship, the horizontal angles between the line joining the stations of the observers and lines drawn from those stations to the object. This method presents great difficulties when the ships are under way, particularly if one is much before, or abaft the beam of the other, and is quite inapplicable if one is on the bow or stern of the other; whereas the former method may be used in all positions of the ships, provided the height of a mast of the enemy's ship be known.

600. **Using Ship's own Mast as the Given Height.** That method will not, however, serve to obtain the distances of steamers, which either have no masts or have them of no regular height. In this case the distance may be determined by making use of the ship's own mast as a given height, causing an observer aloft to measure the angle  $A B C$  (fig. 165), formed by the mast  $A B$ , when

Fig. 165.



*vertical*, and the line of sight  $B C$  from the observer to the enemy's ship at  $C$ ; and then computing the required distance  $A C$ .

An objection to this method is that, when the mast is not in a vertical position at the time of making the observation, it is difficult to have on the deck a point vertically under the observer's eye; and if the observed angle is

one between a line, as  $DC$ , from the observer to the distant ship and the direction  $DA$  of the mast, it would be necessary to introduce a correction to the observed angle; now, as the pendulum, placed in the main hatchway of English men-of-war is useful for other purposes, as in determining the proper instant for firing guns horizontally, or otherwise, so there is nothing to prevent the employment of the instrument for finding the angle of heel in combination with the observation of the angle  $ADC$ ; the correction for the heel, however, will rarely be necessary in good fighting weather.

601. **Two Angles in an Oblique Plane.** Another application in an oblique plane of the horizontal method, mentioned above, has been proposed. Let two observers, each visible from the other, take their stations at the two ends of a rope whose length is accurately measured (say one observer at the main topmast cross-trees, and the other in the main chains, the main topmast backstay will answer for a base), and simultaneously measure the angle between the other observer and the object, the three angles and one side of a triangle are thus obtained, and the side wanted can be readily calculated. The advantage that this plan has over the simple measurement of horizontal angles is that it is equally available whatever may be the bearing of the object; as, for example, if the object be well on the bow, in fact ahead, the jib-stay or the fore topmast stay may be made the base of the triangle, the observers being stationed at the fore topmast cross-trees and jib-boom, or bowsprit respectively.

602. **Buckner's Plan.** The plan following, for measuring distances at sea, was proposed by Lieutenant Wm. P. Buckner, U. S. Navy, and was used with very satis-

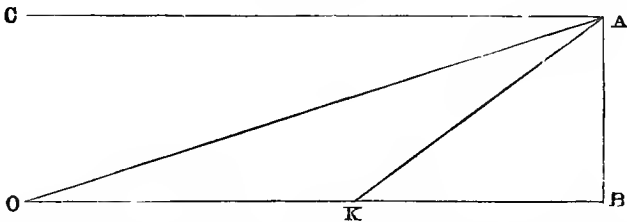
factory results on board of the U. S. Practice Ship Plymouth, during her summer cruise in the year 1860. He states his problem as follows:

**Problem.** To determine the distance of an object at sea by observing its angular distance from (within) the offing.

**Solution.** In this problem we may neglect the curvature of the earth and the terrestrial refraction.

Let O B (fig. 166), represent the sea level; A the

Fig. 166.



position of the observer at the height A B above it; A C a horizontal line, and parallel to it (which is nearly the case); O the offing or edge of the visible horizon; K the object whose distance is required.

We have C A O = dip, see Bowditch, table XIII.

O A K = angular distance of K within the offing;

hence we have

$$K A B = C A B - (C A O + O A K)$$

$$K A B = 90^\circ - (C A O + O A K)$$

A B = height of the observer;

hence in the right triangle K A B we know the angle A and the side A B. We may find K B from the formula

$$\text{tang. } A = \frac{K B}{A B};$$

$$K B = A B. \text{ tang. } A.$$

In computing the following table, K B was assumed

to be at every 100 yards; and then the angle A was calculated for the height of 20, 30, 40, &c. feet.

To use the table, let an observer measure the angle O A K, and look into the table with that angle; opposite to it in the column marked distances, will be found the distance of the object in yards.

### Buckner's Table for Finding the Distance of an Object at Sea.

Yards. Distance.	Height of the eye above the level of the sea, in feet.								
	20	30	40	50	60	70	80	90	100
100	3°.44'	5°.37'	7°.29'	9°.21'	11°.11'	13°.00'	14°.47'	16°.34'	18°.16'
200	1.50	2.46	3.43	4.39	5.35	6.31	7.27	8.23	9.18
300	1.12	1.49	2.26	3.04	3.41	4.19	4.56	5.33	6.11
400	.52	1.21	1.48	2.16	2.44	3.12	3.40	4.08	4.36
500	.41	1.03	1.25	1.48	2.10	2.32	2.54	3.17	3.39
600	.34	.52	1.10	1.29	1.47	2.05	2.24	2.42	3.01
700	.28	.44	1.01	1.15	1.31	1.46	2.01	2.18	2.34
800	.24	.38	.51	1.05	1.18	1.32	1.46	2.00	2.13
900	.21	.33	.45	.57	1.09	1.22	1.33	1.45	1.57
1000	.18	.29	.40	.50	1.01	1.12	1.23	1.34	1.45
1100	.16	.26	.35	.45	.55	1.05	1.15	1.24	1.34
1200	.15	.23	.32	.41	.50	.59	1.08	1.17	1.26
1300	.13	.21	.29	.37	.45	.53	1.02	1.10	1.18
1400	.12	.19	.27	.34	.41	.49	.57	1.04	1.12
1500	.11	.18	.24	.31	.38	.45	.52	.59	1.07
1600	.10	.16	.22	.29	.35	.42	.48	.55	1.02
1700	.09	.15	.21	.27	.33	.39	.45	.51	.58
1800	.08	.14	.19	.25	.31	.36	.42	.48	.54
1900	.08	.13	.18	.23	.29	.34	.39	.45	.50
2000	.07	.12	.17	.22	.27	.32	.37	.42	.47
2100	.06	.11	.16	.20	.25	.30	.35	.40	.45
2200	.06	.10	.15	.19	.24	.28	.33	.38	.42
2300	.05	.10	.14	.18	.22	.27	.31	.36	.40
2400	.05	.09	.13	.17	.21	.25	.29	.34	.38
2500	.05	.08	.12	.16	.20	.24	.28	.32	.36

No correct use of this table can be made when the proximity of land may interfere with the distance of the horizon.

603. **Practice of Firing at Sea.** In the practice of naval gunnery it is most particularly important that the actual delivery of the charge from the piece should

follow, as instantaneously as possible, the action of the lock; for whilst the object aimed at is continually changing its relative position, the direction of the gun is varying so rapidly that if the medium that is to convey ignition to the charge act not very rapidly, the angle of the shot's departure may be two or three degrees above or below that at which the gun was pointed when the lock-string was pulled. For suppose a vessel, in action, be rolling eight degrees, performing each roll in about four seconds of time: when the nature or condition of the primer is bad or defective, it will very frequently happen that an interval of one second of time, and sometimes considerably more, will take place between the pulling of the lock-string and the discharge of the piece; and in that time the elevation of the gun would alter two degrees. With any uncertain or sluggish action of this nature, therefore, it is useless to expect much accuracy of effect, even with the best trained men, and with all other means perfect.

In every case when there is much motion (and there will be a great deal more in steam-propelled than in sailing ships), the shot will not be delivered from the bore until its direction is altered, more or less, from that in which the piece was pointed when the lock-string was pulled. It is, therefore, not only vastly important to use those means that are best calculated to produce the most instantaneous discharge possible, but also to consider which direction, and what particular part of a vessel's motions are most favorable for firing with the greatest prospect of effect, whether to fire on the weather or lee roll, and at what particular stage or crisis of the motion.

A steam-propelled vessel, being agitated by rolling and pitching motions, and often, as in a cross-sea, accompanied by sudden and violent jerks, will, much more than a sailing vessel, try the skill and tact of the gunner, in whom, both for shot and shell firing, is required the greatest promptitude of perception, while the utmost intensity in the action of the lock, and vivacity in the action of the primer are no less necessary.

604. **Crossing the Plane of Fire.** A swift steamer may run across a plane of fire, and, in passing, use her broad-side guns with effect, herself unharmed. Going at the rate of eleven or twelve knots an hour, a steamer from 150 to 200 feet long will run her own length in from nine and a half to twelve seconds. The time of flight of an 8-inch shell or shot, fired at a range of 2,725 yards, being twelve seconds, a shot correctly aimed at the steamer's bow would, by the time it reaches the point aimed at, strike astern of her.

605. **Considerations of the Roll.** In close action, in smooth water, it is not perhaps material whether the ordnance be fired with or against the roll, provided the captains of the guns judge correctly how much their pieces should be pointed above or below the part intended to be hit; but when there is much swell, it is by no means indifferent which of these motions should be preferred. The rule generally laid down for observance in action is to fire when the vessel is nearest on an even keel, that is, upright; and always to prefer a falling side, that is, when rolling toward the enemy.

606. **Position of a Ship with Respect to the Wave, when she is Upright.** To deal with considerations respecting the rolling motions only, we shall suppose the vessel to have

the wind on the beam, for if hauled on a wind, the motion would be compounded of rolling and pitching, by the vessel laying across the swell. Now a vessel under sail, with the wind as described, is nearest upright at or near the end of the roll to windward. Were it not for the action of the wind on the sails, she would be upright when she comes to the top of a wave; but this is not the case in a smart breeze, because it requires some degree of counteracting power from the water under her lee side, as the vessel sinks upon a wave, to compensate for the heel occasioned by the wind. In a heavy swell, however, a vessel will roll to windward considerably beyond the upright position; but in stating a case proper for action, we should not suppose the sea to be so rough as to make the vessel incline much to windward.

Now a vessel brought to that momentary pause which takes place on the termination of the weather roll, just before she begins to feel the rising influence of the next coming wave, must be in the hollow or trough of a sea, and in such a position will have a less commanding view of her enemy than if he were seen from the top of a wave. This preliminary observation may be considered sufficient to show that the maxim of firing when the vessel is on an even keel should not be too generally or absolutely enforced: and having submitted this we proceed to consider the important question that results naturally from it, viz.: whether it is most advantageous to fire with a rising or with a falling side.

607. **Considerations Referring to a Vessel Engaging to Leeward.** A vessel engaging to leeward, that is, fighting her weather guns, must be in the trough of a sea when the side engaged begins to rise; and whilst it is rising

she must be performing a lee roll. The disadvantage of firing from the hollow between two waves having already been shown, the inexpediency of firing at the beginning of the rising motion is also proved, for the one ensues immediately from the other; and a very material objection to the practice of firing during any part of the rising motion comes from this, viz., that the lee slope of a wave being always more abrupt or steep than the weather side, the change which takes place in a vessel's position in making a lee roll, accelerated and increased by the action of the wind, is much more rapid than in rolling to windward; and consequently the direction or inclination of the axis of the guns will in this case be much more quickly and considerably disturbed in firing with the rising than the falling motion.

It appears, then, that in fighting the weather side, we should prefer to *fire at the pause immediately before the commencement of the declining motion or weather roll*, because the ship, being then on the top of a wave, will command a better view of the enemy, and the declining motion will be operating to lessen the slope in the direction of the recoil.

608. **Considerations Referring to a Vessel Engaging to Windward.** In fighting to windward, some of these arguments are reversed. The declining motion of the side engaged is then a *lee-lurch*, and at the commencement of that motion the vessel must be in the trough of the sea. We should, therefore, so far modify the maxim, already suggested, as to *fire at the end of the falling motion of the fighting or lee side*, when the vessel comes to the top of a wave, so that the actual

discharge may not take place after the pause which attends the change of motion.

But modifications, governed by various circumstances, should be made in all such maxims. If, in the first case (fighting the weather guns), a ship be heeling under the influence of a strong breeze, her guns, fired at the commencement of the declining motion, or at the pause which precedes it, will rush in with such violence, from the inclination of the deck being in the direction of the recoil, that the breechings and bolts will frequently be incapable of resisting so severe a shock, particularly when the guns are loaded with two shot; in such cases, consequently, the guns should not be fired until the declining motion be partly performed; thus observing, in principle, the maxim to prefer firing with a falling side.

Under these circumstances, then, the rule should be so far modified, in practice, that in fighting the weather guns they should be laid so that they should bear upon the enemy *when the ship comes up to within 1° of the extreme of the weather roll*; and, in fighting the lee guns, to lay them so that they shall bear *when the ship has made a portion of about 1° of the lee roll from its commencement*. This insures the guns being laid more nearly parallel to the plane of the deck, which is a point of much importance to secure, for the following reasons:

**609. Considerations Referring to the Inclination of the Axis to the Plane of the Deck.** When guns are much depressed, relatively with the plane of the deck, it requires very great experience and tact on the part of the captain of the gun to fire it accurately at the proper moment; for unless he be a very tall man he cannot look

over the gun, at the full extent of the lock-string, when the breech is much raised; and if the gun be fired at this great depression, he is endangered by the rapid and heavy recoil, and great strains are moreover occasioned to the breechings and bolts.

Again, when the lee guns have much elevation with respect to the plane of the deck, a somewhat similar inconvenience is experienced, though in reverse order, by the captain of the gun having to bring his eye down almost to the level of the deck to sight along the gun; and when it is fired in that position, the recoil being up the very great inclination of the deck may not be sufficient of itself to bring the gun sufficiently inboard for loading.

**610. General Conclusion on the Proper time to Fire.** For these reasons, then, in a light wind, with little sea on, it will be best to fire the weather guns from the top of the wave, before the commencement of the weather roll; and to fire the lee guns also from the top of the wave, which will be at the end of the lee roll. In rough weather, however, when the wind is fresh and the sea high, the weather guns should be fired near the end of the weather roll, and the lee guns after a small portion of the lee roll has been made.

At ordinary fighting distances this rule will prevent the necessity of laying the gun at a great depression or elevation with respect to the deck, in all weathers; but when the distance is great, and the weather rough, the being compelled to fire from nearly the trough of the sea, will produce the necessity of a high elevation, which, as has been shown, will inconvenience the captain of the gun in pointing. It may well be questioned /

whether, under such circumstances, there is any advantage likely to be derived from firing at all.

In firing at sea, then, it is simply necessary to push up the breech sight corresponding to the distance of the object, and lay the gun in such a manner that the coincidence of the three points shall occur at that portion of the roll at which it is desired to fire.

611. **Advantages of Firing Low.** The great aim in firing at sea should be not to overshoot the object, and to fire on the downward roll certainly favors this object. It is very important to dismantle an enemy by shooting away his masts, sails, &c., but the hull should be the chief object of aim.

612. **“Hornet” and “Peacock.”** Some of the actions between British and American sloops afford very instructive illustrations on this important point. In the action between the “Hornet” and the “Peacock,” the decisive importance of body blows was strongly displayed. The American ship was a good deal injured in her rigging, though comparatively little damaged in the hull; but the British sloop was forced to surrender in consequence of having been hulled so low that the shot holes could not be got at, and she sauk a few minutes after her surrender.

613. **“Avon” and “Wasp.”** The “Avon” surrendered to the “Wasp” after being reduced to a sinking state by body wounds, and went down immediately after her brave crew was removed. In this affair the American sloop first crippled the Avon’s rigging with dismantling shot, and then aimed at her hull with great success. The Wasp was not materially injured.

In these two actions it is clear that the fire of the

British vessels was thrown too high, and that the fire of the American sloops was expressly and carefully aimed at the hull; and the shot of the former flying too high may be suspected to have arisen, chiefly, from not having chosen the most advantageous moment for firing.

614. **“Frolic” and “Wasp.”** This is better shown by reviewing the action between the “Frolic” and the “Wasp.”

The contending vessels were pretty nearly matched in armament; but the “Frolic” went into action with her main yard sprung. The “Wasp,” having the wind, came down and engaged the “Frolic” to windward, on the port side, and consequently fought her lee side against the weather side of the British sloop. The American sloop was considerably injured in her rigging early in the action, and also received a few shot in her hull, but much more serious damage and severe loss were sustained by the “Frolic.” The reason assigned for the inaccuracy of the fire of the “Frolic” is that, her motion was much more rapid and violent than that of the “Wasp;” but the “rapid motion” which so much disturbed the direction of her fire, appears to have been occasioned by the quick dips of *lee lurches*, for she fired with a rising side, and, as there was a heavy swell, this motion must have very rapidly disturbed the pointing or direction of her guns. That the “Wasp” did not fire with the rising motion we know from her own report; that she did not fire in the hollow of the sea, in such a swell, is evident; and that she did not fire in the *lee lurch* is clear from the admitted fact that the ship rolled the muzzles of her guns to the water’s edge: we can therefore infer, with

certainly, that she fired, in general, from the top of the sea toward the termination of the falling motion.

615. **Dismantling an Enemy.** This case, as thus closely analyzed by Sir Howard Douglas, illustrates very forcibly the advantage of firing with a falling side.

When it is expedient to aim partially at the rigging, one or more guns, conveniently placed, should be named for this purpose specially, and loaded accordingly. When the enemy's ship is close, and there is difficulty in elevating the broadside guns sufficiently to effect this object, the boat-howitzer may be advantageously used, fired over the rail, or from the poop or top-gallant fore-castle. This piece will also be of great service in dislodging the marksmen from the enemy's tops, who at close quarters pick off the men on deck.

Dismantling rigging, and carrying away spars, are more likely to be effected when it blows fresh than in light airs. Carrying away a stay, or a few shrouds, or wounding a mast or spar, in a strong breeze, may occasion a serious crash, which in a light wind would not ensue. With respect to sails, in moderate breezes the perforations of shot leave only small holes; but in strong winds a sail frequently splits upward, as far as the reef-band at least, as soon as it is perforated.

616. **Inefficiency of Random Broadside Firing.** Whether pursuing or pursued, the only chance of stopping an enemy is by bringing down some of his rigging. The random aim of a whole broadside battery will be much less likely to accomplish this than the cool and careful use of one well served gun. *Hauling-up* or *bearing-away*, to rake a flying or pursuing enemy, always produces a very random volley; for as the change of course must occasion

much loss of distance, it is necessary to perform it so quickly that the effect is seldom good, the distance or range altering very much before the vessel comes to a position proper for opening her broadside fire. This alteration of position brings with it a great and unknown alteration in the ship's inclination; consequently a considerable change in the inclination at which the guns may have been laid, and which there is no time to correct. It is almost incredible, indeed, how little effect is produced by this sort of raking fire. A fact is on record which illustrates the truth of these remarks. In a certain action, a 74-gun ship bore up across the stern of an 84, to rake her, at a cable's length distance, in moderate weather and smooth water. The 74 had been on a wind, and not having, perhaps, allowed for the alteration of elevation that would take place after bearing up, not one shot took effect.

617. **Loading in One Motion.** In close action, rapidity of fire is of the most decisive importance, provided accuracy be not sacrificed to it. In close battle, when it is scarcely possible to miss, the vessel that can soonest reload and give her second broadside, supposing both ships to have opened their fire nearly at the same time, must have a prodigious advantage over her opponent. To aid in accomplishing this object, the cartridge, shot, and wad should be thrust home in one motion. In the "Ordnance Instructions," it is directed that this system of loading shall be practised, under the circumstances alluded to, with *unchambered guns*. It does not appear that there is any other objection to this practice than that which arises from the ball being apt to roll on the tie of the cartridge, and thus become jammed in the gun. Such an

accident, however, may easily be prevented by cutting the tie short off, or by fastening it around the body of the cartridge; the French plan is to cut that part of the bag beyond the tie to two inches, and make it up in the form of a cockade.

**618. Explosion of Shells on Concussion.** There is a practice in the British Navy, which has not been adopted in that of the United States, of keeping a certain number of shells (loaded) on deck during an action; the reason assigned is that it may not be practicable to bring up shells from the shell-room rapidly enough for quick broadside firing after an action may have commenced.

This practice is most dangerous, and likely to prove most destructive in its effects, for it is known that any loaded shell at rest, when struck by a solid shot, fired with even a moderate charge, will be exploded, if not with so much violence as when burst by the medium of its fuze, yet with force sufficient to scatter in every direction, and to considerable distances, any other shells that may be placed in near proximity.

**619. Experiments in England.** To test it, sixteen shells were piled on the mud, and fired at with a solid shot from a 32-pounder gun; the result was that the shot, on striking the shell, broke it, exploded the powder it contained, and scattered the other shells in every direction. It was thought that only the shell that had been struck was exploded.

**620. Cause of Explosion on Concussion.** To account for the explosion of a shell on being struck by a shot, it has been surmised that the shot first breaks the shell, and in doing so, elicits a spark which fires the bursting charge contained in it. There is reason to doubt this.

The powder which the shell contained, exploded, according to this supposition, when in a state of dispersion; it could not, therefore, have strength sufficient to scatter the other shells in every direction, so far and so forcibly as in the experiments by which that effect was produced. The only rational way of accounting for this fact is, that the powder contained in the shell was ignited contemporaneously with the breaking of the shell by the blow; and this could only be by the powder in the shell having been exploded by the percussion which develops in the iron a heat sufficient to ignite gunpowder.\* This will also account for the detonation being less than usual, while the force of the explosion was still so great as to produce the above mentioned effects.

621. **Secondary Effects of the Explosion of a Shell.** The direct effect of a shot striking a shell, lying on deck, has been shown, but in addition to this, there are secondary effects which are none the less fraught with danger. The following account of an experiment is sufficient to utterly condemn the practice of keeping shells in any part of the deck when in action. A mass consisting of sixteen 32-pounder 6-inch shells, in their boxes, were piled in three tiers, one above another, but only one tier deep, so that no more than one shell could be struck by the same shot; the mass was then fired at with a solid shot from a 32-pounder gun of 56 cwt., with a charge of 10 lbs., at about sixty or seventy yards distance. The shell struck was broken to pieces, the powder it contained exploded as in the preceding experiment, without much detonation, but with force sufficient to demolish

\* The temperature is raised to 600°.

or injure many of the adjoining boxes, to break the straps by which the shells were fixed to the sabots, and to scatter the shells in various directions to different distances. These were the immediate and direct effects. The secondary effects were, that the fuzes of two shells which had not been struck were ignited, *though capped*, by the explosion of the shell which had been hit, and both burst with full force. Thus the blow of one shot caused, directly and indirectly, the explosion of three shells.

622. **Care in the Use of Shells.** When shells were first introduced into the naval service, they were treated with great care, and inspired considerable dread among those who had the handling of them; but as use and practice has accustomed all to their presence, and it has been found that they do not necessarily explode on being handled, a feeling of too much security in their presence has obtained, and the last extreme is worse than the first. There is no danger to be apprehended from the handling of a shell in a proper manner, but there is every thing to be apprehended from an improper exposure of them to accidental ignition. In action, shells should never be allowed to accumulate on deck, the shell should not be brought to the gun until the loader is ready to put it in the gun, and when brought to the gun it should come directly from the shell-room hatch.

It is evident that shells are infinitely more dangerous on deck than powder in cartridge bags; the latter, if struck by a shot, will be simply scattered, while the effect on the former has been shown to be productive of most serious consequences.

623. **Moral Effect of an Explosion on Deck.** The moral effect produced upon the crew of a ship in action, by the unexpected explosion of one of her own shells, would naturally be far greater than that occasioned by the explosion of an enemy's shell, a contingency which the crew must be prepared to expect. The worst enemy to be dreaded in naval actions is internal explosions; panic is the invariable accompaniment of them.

624. **Position of Shell-Rooms.** There can be no doubt that if a solid shot were to penetrate into a shell-room with much force, and strike a row of shells, as in the experiments cited above, there would be an end of that ship. Every effort should be made then to have the shell-rooms as low as possible below the water line, and not to permit them to extend to the sides of the ship; and, even when all these precautions are taken, the shell-room can still be reached, for when a ship in action heels over from her enemy, as when fighting her weather guns, she exposes much of her side between the actual and usual water-line; also, when she heels toward her enemy, her deck may be penetrated by shot; and again, when engaged at a considerable distance, a shell, fired at a high elevation, may descend upon her deck. Sir Howard Douglas mentions seeing a shell fall upon the deck of a British frigate, when in action, which penetrated into her bread-room and there exploded within a mass of bread in bulk; had the bread-room been a shell-room, there would have been an end of that ship.

625. **Precaution in Passing Shells.** These remarks on the explosion of shells on concussion, must be sufficient to show the great danger of having shells exposed on deck or elsewhere to the fire of the enemy. The prac-

tice of our service should be strictly adhered to, and the shotman should only bring the shell to the gun as it is needed for loading; and it would be well to establish as a rule, for guidance at the hatchways where shells are delivered, that no shotman shall be supplied with a shell without he brings with him his empty shell box, this to be taken as proof that the last shell which was supplied to him is in the gun.

When we consider that shell practice in action is very likely to be conducted at long ranges, and that accuracy is more the object than rapidity of fire, we cannot fear but that shells will be supplied, by this means, quite fast enough for the effective service of the gun.

626. **Premature Explosions.** In connection with the subject of the explosion of shells by concussion, we may add that many premature explosions of shells are now charged to the effect of concussion. It has been hitherto supposed that the frequent bursting of shells in or near the muzzles of guns, when impelled by large charges, arose, in time-fuzed shells, from the dislocation of the composition contained in the fuze; but the reason that is now gaining favor with artillerists is, that the explosion of the shell at the instant of firing can arise from no other cause than that gunpowder is explosive by percussion, and that the *bursting charge is exploded by the shock of discharge*, just as when a loaded shell is struck by a shot it is exploded, not by a spark elicited on the previous breaking of the shell, but, as already stated, by the ignition of its contents contemporaneously with the blow.

627. **To Fill a Shell.** When it is unavoidably necessary to fill shells on board ship, the fuze should be

*carefully brushed and wiped with an oiled rag before it is screwed in; the shell should be filled by means of a funnel, taking care to insert its orifice below the screw in the tap of the shell, so that no grains of powder may lodge in the thread; the female screw in the tap of the shell should also be carefully wiped with an oiled rag.*

628. **Concentration of Fire.** There are moments during an action at sea, when a great advantage might be gained over an enemy by concentrating on one point the entire fire of the battery. In order to be enabled to do this effectively it would be necessary that, at each port, certain marks should be established for the guidance of the captain of the gun. The advantage of a concentrated fire may be better appreciated by citing an example. Suppose the enemy ahead; while ranging up, estimating that by the time he is abeam he will be at a certain distance, lay all the guns in such a manner that the trajectories of their projectiles will intersect each other at the side of the enemy, the direction of the flight of the shot from the midship gun being taken as the basis to which the direction of all the other shots is to be referred. If a ship, with her guns thus laid, should hold her fire until she get into the required position, and then deliver it successfully, her opponent must be either destroyed, or be so seriously injured as to give him but a poor chance of carrying on the fight with any hope of victory.

**Objection to Concentration of Fire.** The argument against the use of this manner of delivering a broadside is that there is more danger of losing the effect of the whole battery than if each piece were pointed and fired independently, for if any mistake were made in the moment of giving the order to fire, the shots, all being di-

rected to the same point, would all miss. This is true, but to guard against this, the captain himself should take his station near the gun chosen as the basis, and give the order when he sees its line of sight on the object.

629. **Sir Howard Douglas on Concentration.** The following rules for concentrating fire on a given point are given by Sir Howard Douglas, as extracted from the Gunnery Instructions Book:

The guns are trained in the direction of the object by bringing them on with lines, hooked to the centre of each port, and held immediately under marks made on the beams or deck overhead, for the several bearings of abeam,  $1\frac{1}{2}$  and 3 points before and abaft the beam, and laid by marked quoin according to the heel of the ship and the distance of the object—the direction being given by aid of an instrument on the upper deck, or by the officer giving the order observing the line of sight of the gun used as the basis. The midship gun is used as the directing gun, and the angles of training should be ascertained for the above bearings at a con-

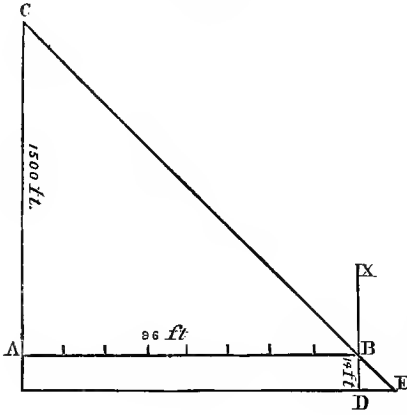
Fig. 167.



stant distance of 500 yards; for though the calculations are made for this distance, yet this method of laying the guns is intended for all ranges within 1,000 yards, at which distance, if the guns are properly laid, both as regards elevation and lateral training, the shot will be at the same distance from each other as on leaving the gun (fig 167).

630. **Concentrating on the Beam.** The angles for concentrating on the beam can be calculated in the following manner:

Fig. 168.

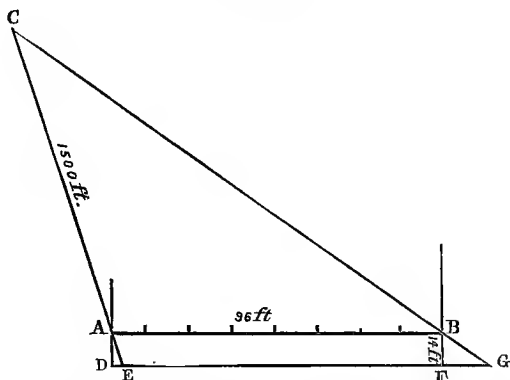


Let A be the midship gun (fig. 168) trained right abeam, B the foremost one, C the object at a constant distance of 500 yards. Let the distance from A to B, supposed known, equal 96 ft., and the distance from the centre of port inboard be taken as 14 ft., being

the same for all the guns. Then the angle C can be easily found, for  $\frac{A B}{A C} = \text{tang. } C$ , which is equal to the angle C B  $x$ , the angle of training for the foremost gun. Again, in triangle B D E, we have  $D E = B D \text{ tang. } C$ , the length of the tangent to be set off overhead from the point opposite the centre of the port. For the intermediate guns, divide the length D E by the number of guns forward of the midship one, which will give the length of the tangent for the gun next to the midship one; twice this will be the length for the next gun, and so on: thus if  $D E = 10.7$  inches, and the number of guns forward of A be 8, we have  $\frac{10.7}{8} = 1.3$  inches, or the length for the gun next to A; 2.6 inches—the length for the next gun, and so on. The same measurements answering for the guns abaft A.

631. **Concentrating three Points Aft the Beam.** To calculate the angles for concentrating three points aft the beam, let A (fig. 169) be the midship gun trained

Fig. 169.



three points aft the beam, B the foremost one, C the object distant 500 yards. Let the distance from A to B, supposed known, equal 96 feet, and the distance from the centre of the port inboard equal 14 feet as before. Then, from the expression

$$AC + AB : AC - AB :: \text{tang. } \frac{1}{2} (B + C) : \text{tang. } \frac{1}{2} (B - C)$$

the angle B may be found, which, taken from  $90^\circ$  will give the angle of training for the foremost gun. Again, in triangles ADE, BFG, we have

$$DE = AD \text{ tang. } A,$$

and

$$FG = FB \text{ tang. } B,$$

which are the required lengths of the tangents to be set off overhead from opposite the centres of these ports. For the intermediate guns, divide the difference between the two lengths DE and FG by the number of guns forward of the midship one, and *add* this common difference to the length DE for the gun next before the

midship one, and so on to each gun in succession. Thus, let  $FG = 10$  ft. 5 in., and  $DE = 9$  ft. 4 in., the difference  $= 1$  ft. 1 in.; let the number of guns forward of  $A$  be 8, then we have  $\frac{13}{8} = 1.6$  inches, the common difference for each gun; therefore 9 ft. 5.6 in.  $=$  the length for the gun forward of  $A$ ; 9 ft. 7.2 in.  $=$  the length for the next gun, and so on.

The measurements for the corresponding guns abaft the midship one will be found by *subtracting* the common difference from  $DE$ , and so on from each gun in succession.

The calculation of the angles for 3 points before the beam, or for  $1\frac{1}{2}$  points before and abaft the beam, is performed in the same manner.

632. **Marking the Beams.** After the angles are calculated, the beams can be marked as follows: Having a line parallel to the keel, overhead, at any convenient distance in rear of the guns, measure the assumed distance 14 feet from the centre of the port inboard, and place a perfectly straight-edged batten there, parallel to the keel line; then transfer the centre of the port to the batten by stretching a line taut across from the centre of two opposite upper port-sills; or, with any length of line as radius, from the centre of the port describe an arc cutting the batten before and abaft the centre; half the distance between these marks will give the point corresponding to the centre of the port. From this centre measure off on the batten, to the right and left, the lengths of the tangents for the different bearings, as calculated above; and then transfer these points to the beams or deck immediately over the batten, taking care

to paint them in such a manner that the marks for one gun may not be mistaken for those of an adjacent gun: the batten is then removed.

633. **Effect of Projectiles. Effect on Wood.** The effect of a projectile fired against wood varies with the nature of the wood and the direction of the penetration. If the projectile strike perpendicular to the fibres, and the fibres be tough and elastic, as in the case of oak, a portion of them are crushed, and others are bent under the pressure of the projectile, but regain their form as soon as it has passed by them. It is found that a hole formed in oak by a ball four inches in diameter, closes up again so as to leave an opening scarcely large enough to measure the depth of penetration. The size of the hole, and the shattering effect increase rapidly for the larger calibres. A 9-inch projectile has been found to leave a hole that does not close up, and to tear away large fragments from the back portion of an oak target representing the side of a ship-of-war, the effect of which on a vessel would have been to injure the crew, or, if the hole had been situated at or below the water-line, to have endangered the vessel. If penetration take place in the direction of the fibres, the piece is almost always split, even by the smallest shot, and splinters are thrown to a considerable distance.

In consequence of the softness of white pine, nearly all the fibres struck are broken, and the orifice is nearly the size of the projectile; for the same reason, the effects of the projectile do not extend much beyond the orifice; pine is, therefore, to be preferred to oak for structures that are not intended to resist cannon projectiles—as block-houses, &c.

634. **Effect on Earth.** When a projectile enters a substance which retains its form, the friction of the particles as they move over the surface of the projectile, depends on the pressure, which diminishes from the point immediately in front to those on the extreme sides, where it is nothing. A cone of matter will thus be formed in front of the projectile, on the included particles of which the friction will be so great that they will not move over the surface, but will be pushed forward in front of the projectile.

Earth possesses advantages over all other materials, as a covering against projectiles; it is cheap and easily obtained, it offers considerable resistance to penetration, and to a certain extent regains its position after displacement. It is found by experience that a projectile has very little effect on an earthen parapet, unless it passes completely through it; and that injury done by the enemy's artillery by day can be promptly repaired at night.

635. **Penetration.** The resistance which a projectile encounters in penetration, arises from the cohesion and inertia of the particles, and the friction of the particles against the surface of the projectile. Penetrations of different spherical projectiles into a given substance are proportional to the squares of the velocities of impact, and to the diameters and densities of the projectiles.

636. **Effect on Masonry.** The effect of a projectile against masonry is to form a truncated conical hole, terminated by another of a cylindrical form. The material in front of and around the projectile is broken and shattered, and, at the end of the cylindrical hole even, reduced to powder. Pieces of the masonry are some-

times thrown 50 or 60 yards from the wall. The elasticity developed by the shock reacts upon the projectile, sometimes throwing it back 150 yards. The exterior opening varies from 4 to 5 times the diameter of the projectile, and the depth, as we have seen, varies with the size and density of the projectile, and its velocity.

637. **Effect of Bullets.** The penetration of the rifle-musket bullet, in a target made of pine boards, one inch thick, is as follows:

At 200 yards,	- - - -	11 inches.
“ 600 “	- - - -	6 $\frac{1}{2}$ “
“ 1000 “	- - - -	3 $\frac{1}{2}$

From experiments, the following relations were found between the penetration of a bullet in pine, and its effects upon the body of a living horse, viz.:

1st. When the force of the bullet is sufficient to penetrate .31 inch into pine, it is only sufficient to produce a slight contusion of the skin.

2d. When the force of penetration is equal to 0.63 inch, the wound begins to be dangerous, but does not always disable.

3d. When the force of penetration is equal to 1.2 inches the wound is very dangerous.

It will thus be seen that the present bullet is capable of producing very dangerous wounds at a much greater distance than 1,000 yards.

A rope matting or *mantlet* 3 $\frac{1}{2}$  inches thick, is found to resist small-arm projectiles at all distances; it may, therefore, be employed, as it was at the siege of Sebastopol, to screen the men at a gun from the enemy's riflemen.

A field-cannon ball has sufficient force to disable seven

or eight men at a distance of 900 yards. It is stated that a single cannon ball has been known to disable forty-two men—distance not given.

638. **Effect on Water.** In 1848 some experiments were made to try the penetration of shot into water, when fired with small angles of depression toward its surface. In these experiments three targets were placed vertically in the water, 8 feet asunder, the nearest being about 37 yards from the muzzle of a gun, which was a 32-pounder, and charged with 10 lbs. of powder.

When the gun was depressed 7 degrees, the shot struck the first target at the water's edge, and, passing through it, rose from thence and pierced the other targets at the height of 12 and 18 inches above the water.

The gun was fired once with a depression of 9 degrees, when the shot did not come up again. It passed through the first target at 2 feet under water, and, grazing along the mud, rebounded from the second target, having entirely lost its force. With a depression of 7 degrees, the shot being fired into the water where it was 1 foot deep, rose, after grazing about 8 feet along the mud, and at length fell at a distance of 400 yards. Being fired with the same depression into water 2 feet deep, the shot did not reach the mud, but immediately rose and finally fell about 600 yards off.

In order to ascertain if shot reflected from water would damage a ship, shots from a 32-pounder, with a charge of 10 lbs. and a depression of 7 degrees, were fired, and the following are some of the effects produced: At the distance of 16 yards, the shot struck the water at four feet from the ship's side, and in one experiment it lodged in the cutwater; in another it indented the

ship's side, and in both cases it struck at 18 inches below the water-line. At the distance of 36 yards, with a depression of five degrees, the shot struck the water at distances from the ship's side varying from 2 to 15 feet; and ricocheting, entered the ship at distances above the water-line varying from 2 inches to 3 feet.

In consequence of the loss of force which the balls, in all these experiments, sustained by striking the water, it has been inferred that, if a shot be fired with such a depression as a ship's gun will bear, it will not penetrate into water more than 2 feet; and consequently that it will be impossible to injure a ship by firing at her under water.

The experiments cited above were made with spherical balls; but elongated rifle-shot fired into the water have the faculty of entering and passing through the fluid in the direction of their axis, and, after passing through many feet of water, retain force sufficient to penetrate any ship's side below the water-line. This was proved by firing Whitworth's hexagonal shot under circumstances nearly similar to the preceding experiments against a ship's side, when a flat-headed hexagonal shot fired from a 24-pounder passed through 33 feet of water, and then penetrated into the ship through 12 or 14 inches of oak beams and planking. This peculiar faculty of elongated rifle-shot may prove very destructive, if not fatal, to a ship close alongside, by a perforation so low that it cannot be easily plugged. But from what has been stated, this effect can only be produced at short ranges when the elongated shot enters fairly into the water in the direction of its length. And if the perforation be made through iron sides it

cannot be plugged from within, nor could the parasol plug be applied.

639. **Naval Duels.** Good gunnery cannot avail except in connection with good tactics, and in naval duels, or in conflicts on the water carried on between two ships only, it is highly important that particular attention should be given to the manner in which the engagement is commenced, for upon this the result will chiefly depend, if the two vessels be of equal armament.

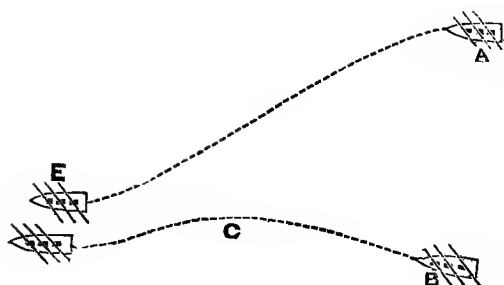
640. **“Guerrière” and “Constitution.”** In the action between the “Guerrière” and “Constitution” there was a good deal of manœuvring, yet the general course of the two ships converged gradually toward each other in a degree which admitted of at least an hour’s occasional cannonade before close action was commenced. The wind was fresh from the north. When the vessels first distinguished each other, the “Guerrière” was to leeward, close hauled upon the starboard tack, the “Constitution” on her weather beam standing S. S. W. The “Guerrière” opened her fire first (which it is said fell short) and soon afterward the “Constitution” opened her battery, and continued to fire occasionally as she came down. When she began to draw near the “Guerrière,” the British frigate wore several times to avoid being raked. This manœuvre operated against closing, which accordingly did not take place until about an hour after the action had commenced. Thus, from the time that the fire opened till close battle began, the vessels, steering free, kept up a sort of running fight upon courses gradually converging toward each other. In what has been stated before be at all correct as to the trifling effect usually produced by random broadside



nonade, and approximate gradually to close battle, then it is evident that the other vessel should vary its plan of operations, to defeat the purpose which the enemy has in view, and which is soon perceptible in his actions.

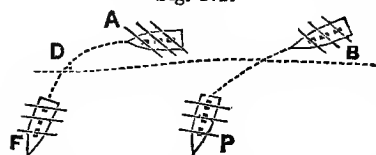
642. **Rule for Chasing to Leeward.** According to the well known principle of chasing to leeward, the course should be so regulated that the chase always bear on the same point of the compass; if she be found to draw ahead, the chaser must haul more up; if the chase draw aft, the pursuer must keep more away. Applying this to the last figure, the more B draws aft, that is, the slower he goes, the more direct must be A's approach according to this principle of chasing. Now suppose B, instead of standing on rapidly in the line B C, converging gradually toward A's course, were to remain as stationary as possible, keeping her broadside turned toward A, it is evident that A (whom we suppose desirous of coming to close action), cannot approach under the fire of B without obvious disadvantage; consequently the slower B moves on the line B C, the more inclined to that line must be the course of A's advance, as A D, and the more he will be exposed to a raking fire in coming down. If the ship A be so circumspect as to come down on a line A E, out of range, B should not, on any account, stand on to meet him if the relative force of the ships demands circumspection on the part of B, for doing this would be acting exactly in the manner A wishes, as is evident by such a movement falling in with his plan of attack. But if A come down in any line A D within range, then B should follow him with his broadside steadily bearing, as F, and in this way should not object to close action, *the previous advantage having been his.*

Fig. 171.



then run up for close action, and raking A's tern, as at C, engage him to leeward if he will permit. If A should decline this, and bear up as at F (fig. 172), to avoid be-

Fig. 172.

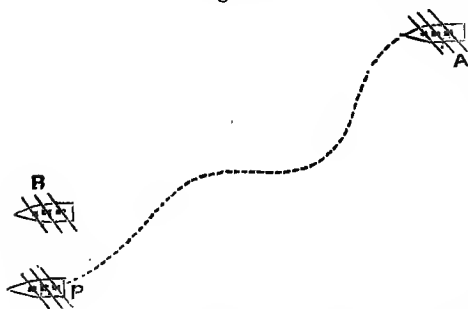


ing raked, B may either do so too, and engage him going free at P, on even terms, or stand on, and crossing his stern at D,

keep his wind, and manœuvre afresh.

643. **Coming Down Aboard the Beam.** But, it may be said, a cautious intelligent enemy, attacking from the windward, will come down aboard B's line of fire (fig. 173),

Fig. 173.

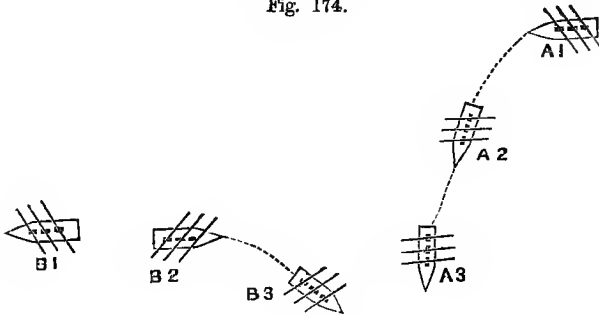


and when nearly in his wake, either run up to windward, or pass to leeward, as he may choose, if B will wait for him, or if A outsail B. But whether the action is to be thus fought

or not, will neither depend upon B's sailing nor upon A's pleasure, if B manœuvre properly, for if he have

any reason for not desiring such a plan of action, and should not think proper to give A an opportunity of raking his stern, in passing to engage him to leeward, he should tack or wear at a convenient time while A is still out of range, and stand on slowly the other way. Thus if A 1 (fig. 174), perceiving B 1 lying to leeward, shape a

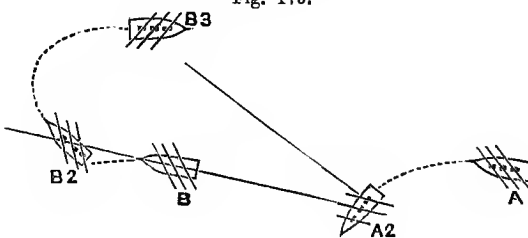
Fig. 174.



course to run down into his wake, B 1 should tack or wear in time, and stand on, as B 2 toward A 2; and this manœuvre will bring the case exactly to that which has been considered in figure 170. If B 1, neglecting or waiving this, stand on, and let A 1 get close in his wake, then A 1 may bear up, and raking B 1's stern, engage him to leeward.

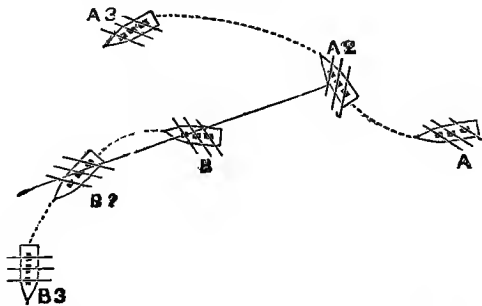
644. **Danger of Allowing the Enemy to Approach in your Wake.** There is no way in which B 1, having permitted A 1 to come close in his wake, can now avoid sus-

Fig. 175.



taining some previous disadvantage, if A 1 should try to rake his stern. For if B 1 tack to avoid it, he will first expose his stern, B (fig. 175), to be raked; he will be severely punished whilst in stays by a fire in great part diagonal; if he hang in stays, he will be utterly destroyed; and in coming around on the other tack, he may fall off nearly end on toward A 2, as at B 3. No good officer, indeed, would attempt such a method of avoiding being raked; and if, on the contrary, B bear up, as B 2 (fig. 176), to prevent this, her opponent A

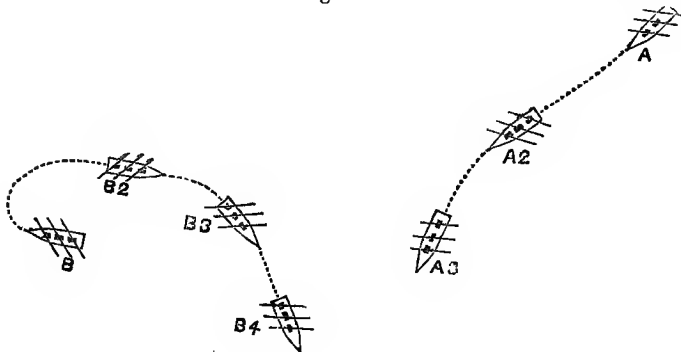
Fig. 176.



may luff up, and rake him before B can get away, and then manœuvre for fresh advantage.

Now if, on the contrary, B should have tacked, as

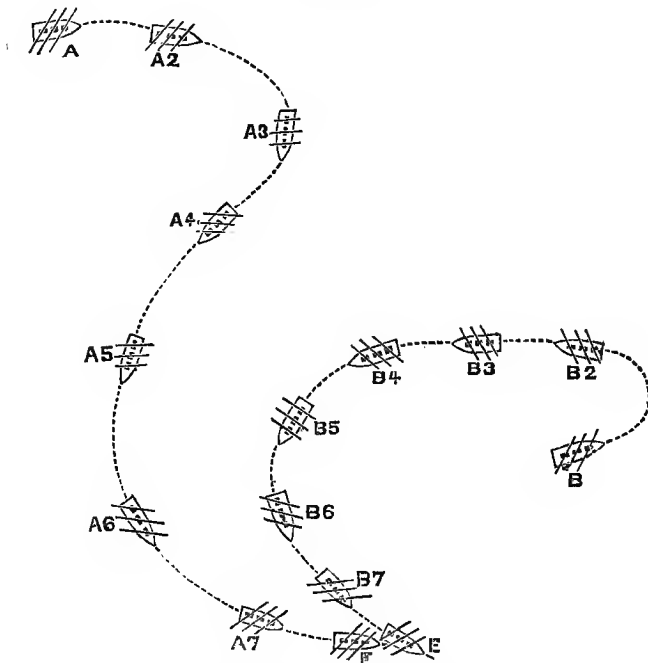
Fig. 177.



suggested before, and stand on toward A, as B 2 (figs. 174 and 177), then, if the offensive movement be continued within range, B should deaden his way as much as possible, and open his fire upon A coming down, keeping his broadside, as at B 3, B 4, steadily bearing, and thus follow the movement of A 2, A 3, gradually, till both ships come close together; and thus again the commander of B could have no objection to close action, *the previous advantage having been his.*

645. **Proper Plan of Receiving the Attack from to Windward.** If the reasoning be correct, the best way for a vessel, B (fig. 178), to leeward, to receive an attack

Fig. 178.



with circumspection, from a vessel, A, to windward, is never to let A come down into his wake; but having

tacked in time, as B 2, stand on slowly till A approach within B's fire, from which time B should keep as stationary as possible. Supposing the vessels to be of nearly equal force, it may be assumed that A has no intention of avoiding action; but after he is once brought to the position A 4, it is evident he cannot approach nearer to B, manœuvring thus, without receiving a mass of fire which he cannot return. If he shape his course to cross B's bows, the counter manœuvre which B should apply is not velocity, but gradual change of position, in steady broadside bearing, with as little way as possible, following A's bows with the broadside so long as he tries to cross B's bow, an attempt which only can be continued until A come close to the wind on the port tack, and here again there would be no objection to bring on close action in this way, the previous advantage having been to B. If, in thus coming to the wind, the vessels should get foul of each other, it will be in a position favorable to B, as E F (fig. 178), if the manœuvre have been properly and steadily executed; and this will bring on a new character of combat, viz.: boarding.

These manœuvres will, at all events, refuse to A the opportunities of which we have supposed him to be desirous, viz.: previous distant cannonade on his own terms; and therefore it appears that this method of manœuvring, in receiving an attack from the windward, is favorable for ships which are not at liberty to receive battle under any disadvantageous tactical circumstances.

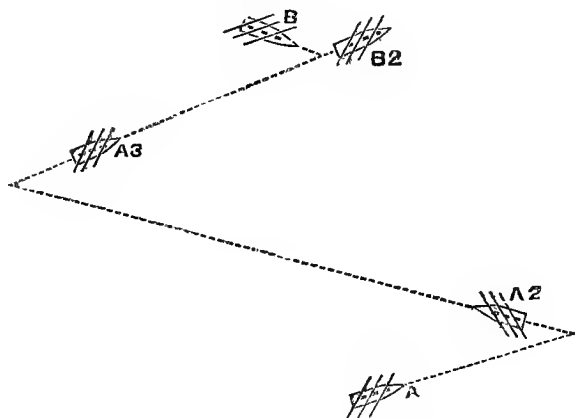
646. "**Macedonian**" and "**United States.**" The action between the "**Macedonian**" and the "**United States,**"

was, in tactical circumstances, of a nature different from those cases which have been considered. The British frigate was to windward, and ran directly down upon the "United States;" but, in doing this, she was so severely damaged that the upper deck was almost entirely disabled by the raking fire of the "United States," then lying steadily to leeward.

In doing this, the British frigate committed a great error in tactics; she should have commenced with the ordinary manœuvre of running down in the wake.

647. **Receiving an Attack from to Leeward.** If, however, the British frigate, represented by B (fig. 179), declining this, had been brought to, as at B 2, the "United States," A, fancying her rather shy, would cer-

Fig. 179.



tainly, after some time have approached. This she probably would have done by tacking, as at A 2, and standing close upon the starboard tack into B's wake, and thence tacking toward her, as at A 3. Now if A tack in B's wake, A cannot go to windward of B, nor rake him, except partially by luffing up in the wind, or





# I N D E X.

---

	ART.		ART.
ACCURACY, Influence of wind on . . .	345	CANNON, Ancient Breech-Loading . .	20
AGE, Effect of on Endurance . . . . .	147	Early Methods of Firing . . . . .	419
ANCIENT ENGINES OF WAR . . . . .	9	Form of . . . . .	100
ANGLE, of Greatest Range in Air . .	469	Exterior Form of . . . . .	105
Of Arrival . . . . .	501	Length of . . . . .	103
Of Fire . . . . .	502	Model for . . . . .	58
ANCIENT MEN-OF-WAR . . . . .	14	Introduction of Cast-Iron for . . .	21
ARMS . . . . .	4	Inspection of . . . . .	81
ANCIENT MUSQUETEER . . . . .	8	Marking . . . . .	99
ARMADA OF PHILIP II . . . . .	24	Lifetime of . . . . .	130
ARMSTRONG AND WHITWORTH GUNS		Indication of Effect of Service in	
COMPARED . . . . .	569	Iron . . . . .	128
ATMOSPHERE, Resistance of the . . .	319	Substances Used in the Manufac-	
		ture of . . . . .	35
BALLISTA . . . . .	10	Injuries to . . . . .	121
BALLISTIC PENDULUM . . . . .	244	Strengthening Bands on . . . . .	131
BATTERING RAM . . . . .	11	Col. Bumford's Plan for Deter-	
BUNSEN'S BATTERIES . . . . .	268	mining Decrease in the Thickness of	
BED AND QUOIN . . . . .	167, 186	Metal for . . . . .	101
Porter's . . . . .	189	Capt. Rodman's Improvement on	
BOLTS Connecting Brackets and Axle-		the Plan of Col. Bumford . . . .	102
trees . . . . .	169	Effect of Re-entering Angles on . .	134
BORE, Length of . . . . .	89	Effect of Irregularities on the Sur-	
Form of the Bottom of . . . . .	113	face of . . . . .	140
BORING . . . . .	68, 70, 75	Preservation of . . . . .	151
BOW . . . . .	6	To Render Unserviceable . . . . .	149
BREAST-PIECE . . . . .	166	To Unspike a . . . . .	150
BREECH, Thickness at the . . . . .	104	Armstrong's Plan of Construction	
Loading . . . . .	507	of, Identical with that of Prof.	
Loading Cannon, Objections to . .	570	Treadwell . . . . .	559
Sights, Marking . . . . .	488, 489	Babcock's Plan of Constructing . .	576
BREECHING . . . . .	156	CARRIAGE, Navy Four-Truck . . . .	164, 165
Compound . . . . .	157	Advantages of the Navy Four-	
BRONZE . . . . .	39	Truck . . . . .	171
BRONZE CANNON, Injuries to . . . . .	124	Objections to the Navy Four-Truck.	172
Increasing Durability of . . . . .	127	CARCASSES . . . . .	313
BULLETS, Effect of . . . . .	637	CARRONADES, Introduction of . . . .	29
CALIBRE . . . . .	303	CARTRIDGES, Effect of Varying the	
Advantage of Large . . . . .	460	Length and Diameter of . . . . .	248
Resumé of the History of . . . . .	33	CASTING . . . . .	64
CANNON, Nomenclature of . . . . .	80	On a Core . . . . .	72
Ancient . . . . .	16	Rodman's Plan of Hollow . . . . .	143, 144
Ancient Wrought-Iron . . . . .	19	Effect of Unequal Shrinking in the,	142
		Shot and Shells . . . . .	287, 288

	ART.		ART.
CATAPULTA .....	10	ELONGATED FORM OF BULLET, Ad-	
CHAMBERS .....	112	vantages of .....	523
Effect of Size of .....	239	EPROUVETTES .....	241, 255
CHARCOAL .....	198	Ranges by .....	242
Obtaining by Distillation .....	199	EXPERIENCE OF THE WAR OF 1812,	34
Temperature at which Prepared ..	200	FIRE, Concentration of .....	628 to 632
COLES' REVOLVING TOWERS .....	592	General Conclusions on the Proper	
COMBUSTION .....	218	Time to .....	610
More Rapid in a Closed Space ..	219	FIRING LOW, Advantage of .....	611
Causes that Effect the Velocity		"Hornet" and "Peacock" .....	612
of .....	225, &c., to 232	"Avon" and "Wasp" .....	613
COMING DOWN ABAFT THE BEAM ..	643	"Frolic" and "Wasp" .....	614
COMPOSITION, Moulding .....	56	FLASKS .....	59
CONSIDERATIONS, Referring to a Ves-		FORGING WROUGHT-IRON CANNON ..	77
scl Engaging to Leeward .....	607	FRACTURES, Course of in Cast-Iron	
Referring to a Vessel Engaging to		Cannon .....	132
Windward .....	608	FRICITION CARRIAGES .....	155
Referring to the Inclination of the		FUZE .....	377
Axis to the Plane of the Deck ..	609	Time-Fuze .....	378
COOLING, Effect of Unequal Rapid-		Concussion .....	379, 397, 398
ity in .....	141	Percussion .....	380, 413
Arrangement of the Crystals of		Case .....	381
Iron in .....	135	Metallic Case .....	382
COPPER .....	38	Paper Case .....	383, 386
CRANES .....	63	Safety-Plug, Water Cap .....	384, 385
CROSS-BOW .....	7	Cases of other Nations .....	387
DANGER OF ALLOWING THE ENEMY		English .....	388
TO APPROACH IN YOUR WAKE ..	644	Injuries to, from Shocks .....	389
DEVIATIONS, Direction of, not Con-		Splingard's Shrapnel .....	390
stant .....	322	Boxer's .....	391
Magnus' Experiments on, 325, 326,	327	Bormann, Operation of .....	392, 393
Influence of Velocity on .....	336	French Shrapnel .....	396
Case of no Deviatiou .....	337	Prussian .....	401 to 405
Not Due to Pointing .....	462	Schonstedt .....	406
Vertical, Corresponding to Errors		Snoeck .....	407
of Hausse .....	479	Splingard's Concussion .....	408, 409
Resulting from Difference of Level		Moorson's .....	415, 414
of the Trucks .....	492 to 495	Bourbon .....	416
Magnus' Theory of, with Elongated		West Point .....	418
Projectiles .....	530, 531, 532	Objection to Concussion .....	412
DIRECT FIRE .....	471	Armstrong's .....	551
DISPART SIGHT .....	481 to 484	GAUGE, Ring .....	294
DISMANTLING AN ENEMY .....	615	Cylinder .....	84, 295
DETERMINING DISTANCES OF OBJECTS		Star .....	85
AT SEA .....	597 to 601	GUN-CARRIAGE, Conditions required	
DISTANCE OF OBJECT DETERMINED BY		of .....	152
BUCKNER'S PLAN .....	602	Three Forms of .....	163
DOUBLE-SHOTTING .....	580 to 583	Ward's .....	173
DRIFT .....	522, 535	Cast-Iron .....	161
French Theory of .....	529	Wrought-Iron .....	162
DROOPING AT THE MUZZLE .....	125	Wahrendorff's .....	543
DUST-MILL .....	206	Armstrong's .....	555
ECCENTRICITY .....	328, 332	Deterioration of .....	160
In Shells .....	334	GRAVITY .....	435
Effect of, on Range and Accura-		GREENER'S EXPANSIVE BULLET ..	520
cy .....	329, 330	GROOVES, Want of, on the Pritchett	
Explaining Anomalies .....	333	Bullet Compensated by the more	
EHRESTHAM CARRIAGE .....	178	Forward Position of the Centre	
ELEVATING SCREW .....	187	of Gravity .....	536

	ART.		ART.
GUNNERY, Ordnance and . . . . .	1	LEPANTO, Battle of . . . . .	23
GUN-PENDULUM, Correct Results obtained with a Six-Pounder . . . . .	256	LOADING IN ONE MOTION . . . . .	617
GUNPOWDER, Origin of . . . . .	191, 192	LOCKS, First Application of, to Cannon . . . . .	423
Invention of . . . . .	15	Navy . . . . .	430, 431
Proportion of the Ingredients for, . . . . .	204	Improvement in Mounting the Hammer of . . . . .	432
Incorporation of . . . . .	205	LODGEMENTS, Professor Daniel Treadwell on . . . . .	120
Graining . . . . .	209	MARSHALL CARRIAGE . . . . .	177
Advantages of Graining . . . . .	215	MARSILLY CARRIAGE . . . . .	175
Size of Grain of . . . . .	212	MATCH . . . . .	420
Glazing . . . . .	210	MODELS . . . . .	57
Effect of Glazing . . . . .	211	MORTAR . . . . .	27
Inspection of . . . . .	224	MOULDS . . . . .	55
Temperature Necessary for the Inflammation of . . . . .	221	MOULDING COMPOSITION . . . . .	56
Causes that will produce Inflammation of . . . . .	222	MOULDING, Process of . . . . .	60
Methods in Use for Inflaming . . . . .	223	MOUNTING GUNS, Rule for . . . . .	190
Chemical Definition of the Ingredients of . . . . .	216	NAVAL DUELS . . . . .	639
Phenomena Attending the Change of, from a Solid to a Gaseous State . . . . .	217	"Guerrière" and "Constitution" . . . . .	640
Character of the Gases of . . . . .	233	"Macedonian" and "United States" . . . . .	646
Rate of Burning of . . . . .	220	NAVEZ' MACHINE . . . . .	261, 266, 267
Proof of . . . . .	240, 254	The Pendulum . . . . .	263
Proof of, for Small Arms . . . . .	258	The Conjunctor . . . . .	264
Storage of . . . . .	280, 281	The Disjunctor . . . . .	265
Packing . . . . .	213	Manner of Using . . . . .	269 to 279
Marking Barrels . . . . .	214	NEGATIVE HAUSSE . . . . .	480
Proportioning Charges of . . . . .	284	NITRE . . . . .	193
Maximum Charge of . . . . .	237	Walls . . . . .	195
Advantage of Quick in Small Charges . . . . .	236	Method of Obtaining . . . . .	196
Advantage of Slow in Large Charges . . . . .	235	Artificially Obtained . . . . .	194
Capacity of, for Resisting Moisture . . . . .	259	Pulverizing . . . . .	197
Damaged . . . . .	282	NOMENCLATURE OF CANNON . . . . .	80
GUN-COTTON . . . . .	283	NORTON'S LIQUID FIRE . . . . .	317
HARMLESSNESS OF NON-ELASTIC FORCE . . . . .	234	ORDNANCE AND GUNNERY . . . . .	1
HEIGHT, Effect of, on Gun-Carriages, . . . . .	159	PENDULUM HAUSSE . . . . .	496
Of the Curve in Vacuo . . . . .	452 to 455	PENETRATION . . . . .	635
Of the Curve in Air . . . . .	468	Of Navy Ordnance . . . . .	346
HELIX . . . . .	515	Effect of a Shell dependent on, . . . . .	410, 411
HOLLOW CASTING . . . . .	143	PERCUSSION . . . . .	424
INEFFICIENCY OF RANDOM BROADSIDE FIRING . . . . .	616	Wafer . . . . .	425
INSPECTION, of Cannon . . . . .	81	Cap for Cannon . . . . .	426
Variations Allowed from True Dimensions in . . . . .	94	Union of the Tube with the Wafer, . . . . .	427
IRON, Cast . . . . .	36, 46, 50	Navy Primer . . . . .	428
Wrought . . . . .	37, 53	English Primer . . . . .	429
Cased Ships . . . . .	588	PHENOMENA IN BORE ON COMBUSTION OF CHARGE . . . . .	119
La "Gloire" . . . . .	593, 594, 595	PIVOT CARRIAGE . . . . .	179, 180, 181
The "Warrior" . . . . .	596	POINT-BLANK . . . . .	474, 476, 485
JONES' INCLINED SIDES . . . . .	591	POINTING . . . . .	472
		By means of the handles . . . . .	498
		Side . . . . .	497
		PORT-FIRE . . . . .	421
		POUNDING MILL . . . . .	205
		PRACTICE OF FIRING AT SEA . . . . .	603
		PREPONDERANCE . . . . .	115
		PRIMING CANNON . . . . .	422

	ART.		ART.
PRIMERS—Friction . . . . .	433	RIFLE, Bullet without wedge . . . . .	517
English friction . . . . .	434	Pritchett bullet . . . . .	518
PROJECTILES, moulds for . . . . .	285	United States Navy bullet . . . . .	519
Models for . . . . .	286	Theory of motion . . . . .	521, 524
Form of, . . . . .	318	Grooves on the Bullet . . . . .	525, 533
Polishing . . . . .	289	Influence causing the Bullet to	
Advantage of large calibre of . . . . .	338	strike point foremost . . . . .	534
Advantage of great density of . . . . .	339	Cannon . . . . .	538
Advantages of the spherical form		French Cannon . . . . .	539
for . . . . .	340, 344	Lancaster Cannon . . . . .	540
Advantages of the elongated form		Cavalli Cannon . . . . .	541
for . . . . .	341	Wahrendorff Cannon . . . . .	542
Requirement for accuracy with		Napoleon Cannon . . . . .	544
elongated . . . . .	342	Armstrong Cannon . . . . .	545 to 557
Resistance to elongated and spherical		Whitworth Cannon . . . . .	560, 561, 562
compared . . . . .	343	Blakely Cannon . . . . .	575
Best position for preponderating		Parrott Cannon . . . . .	573
side of . . . . .	335	Whitworth Projectile . . . . .	563
Effect of on Wood . . . . .	633	Armstrong Projectile . . . . .	550
Effect of on Earth . . . . .	634	James' Projectile . . . . .	571
Effect of on Masonry . . . . .	636	Sawyer's Projectile . . . . .	572
Effect of on Water . . . . .	638	Parrott's Projectile . . . . .	574
PROOF—Preliminary of Cannon . . . . .	96	Spanish Projectile . . . . .	575
Powder of Cannon . . . . .	95	Napoleon Projectile . . . . .	544
Water of Cannon . . . . .	97	Schenkl Projectile . . . . .	577
Injury to Cannon in . . . . .	126	Advantage of, limited to long	
PULVERIZING NITRE . . . . .	197	ranges . . . . .	566, 567
		Initial velocity of Projectiles . . . . .	578
QUOIN, Bed and . . . . .	167, 186	RIMBASES . . . . .	116
Ward's Screw . . . . .	188	ROCKET . . . . .	347
Porter's Bed and . . . . .	189	Signal . . . . .	348
		The Former . . . . .	349
RANGE . . . . .	456, 457, 458	The Choke . . . . .	350
In air . . . . .	466, 467	Composition . . . . .	351
Condemning as unserviceable . . . . .	243	Mould for . . . . .	352
RECEIVING AN ATTACK FROM TO		Driving the Composition . . . . .	353
WINDWARD . . . . .	641, 645	Pots . . . . .	355
RECEIVING AN ATTACK FROM TO LEE-		Cones . . . . .	356
WARD . . . . .	647	Making up the . . . . .	358
RULE FOR CHASING TO LEEWARD . . . . .	642	Stick . . . . .	359, 363
RECOIL . . . . .	106	Decorations . . . . .	360
Limit to . . . . .	154	Congreve . . . . .	361
Necessity of . . . . .	153	Motive power of the . . . . .	362
Effect of, on range . . . . .	107, 108	Range of . . . . .	364
Plan of controlling . . . . .	579	British . . . . .	365
RELATION BETWEEN TOTAL HAUSSE		Shell . . . . .	366
AND TIME OF FLIGHT . . . . .	491	Uncertainty of practice with . . . . .	367
RESISTANCE OF THE AIR . . . . .	438, 459	Limited usefulness of the . . . . .	368
RICOCHET FIRING . . . . .	500	Incendiary properties of the . . . . .	369
RIFLE, Inaccuracies intended to cor-		Trajectory of the . . . . .	370
rect . . . . .	503	Fired from Cannon . . . . .	371
Object of the motion . . . . .	505	Hale's . . . . .	372, 373, 374
Methods of imparting the motion . . . . .	506	Hale's Tube for Broadside firing . . . . .	375
Maynard's . . . . .	508	ROLL, considerations of the . . . . .	605, 606
Delvigne's . . . . .	509	ROLLING MILL . . . . .	207
à tige . . . . .	510	ROMME CARRIAGE . . . . .	176
Grooves . . . . .	511	ROTATION . . . . .	461
Twist . . . . .	512	Effect of, on projectiles fired en	
Gaining twist . . . . .	513	ricochet . . . . .	331
Depth of Grooves . . . . .	514	ROTARY MACHINE . . . . .	260
With ball à culot (wedge) . . . . .	516	"ROYAL PRINCE," Armament of the	25

	ART.		ART.
RULE FOR DETERMINING WEIGHT OF SHOT AND SHELLS .....	292	TANGENT SCALE .....	475, 477, 478
SABOTS .....	314	THE TOWER .....	13
“SANTISSIMA TRINIDAD,” Armament of the .....	30	TRAJECTORY, In Vacuo .....	449, 450, 451
SEARCHER .....	83	In the Air .....	463, 464, 465
SHELLS .....	309	TREADWELL'S PLAN OF CONSTRUCTING CANNON .....	558
Explosion of, on Concussion, 618 to .....	621	TRUCKS FOR NAVY GUN-CARRIAGE .....	158
Care in the Use of .....	622	TRUNNION .....	114
To Fill a Shell .....	627	Effect of .....	145
Position of Shell-Rooms .....	624	Holes .....	168
Precaution in Passing .....	625	Rule .....	88
Premature Explosion of .....	626	Square .....	86
Inspection of .....	297 to 302	TURNING .....	73
Navy Shot and .....	290	VAN BRUNT'S CARRIAGE .....	182
Martin's .....	316	Self-Compressing .....	184
SHOT, Weighing .....	291	VELOCITY, Of a Falling Body .....	440
Inspection of .....	293	Initial .....	257
Hot .....	315	VENT .....	117
Bar .....	304	Inclination of .....	91
Chain .....	305	Position of .....	90
Grape .....	306	Influence of Position of .....	118
Canister .....	307	Inspection of .....	129
Hollow .....	308	THE “VICTORY,” Armament of .....	31
Effect of, on Iron .....	584 to 587	VIBRATION, Effect of Irregularities on the Surface of Cannon .....	140
SPHERICAL CASE, OR SHRAPNEL .....	310	WADS, Effect of Junk .....	247
Charging .....	311	WARD'S GUN-CARRIAGE .....	173
English .....	312	Gun-Carriage compared with Four-Truck Carriage .....	174
SIGHT NOTCHES .....	473	Screw Quoin .....	188
SIGHTS FITTED TO NAVY CANNON .....	486	WEAKNESS OF A GUN in the Direction of its Length, as compared with its Power of resisting Longitudinal Strain .....	547
SIGHT-BAR, Use of the Graduations between “Level” and Range at Level .....	487	WHITWORTH AND ARMSTRONG GUNS COMPARED .....	569
SLING .....	5	Reason for the Greater Range of the Smaller Calibre .....	568
SMELTING .....	48	WINDAGE .....	110, 320
“SOVEREIGN OF THE SEAS,” Armament of .....	26	Loss of Force by .....	246
STEEL, for Cannon .....	54, 79	Effect of Reducing .....	249 to 252
STEPS OF THE CARRIAGE .....	170	Effect of Escape of Gas through Ring .....	253
STRAIN, Unequal on the Exterior and Interior of Cannon .....	133	Inaccuracies Caused by .....	321
Increase of, due to Increase of Calibre .....	122	Suppression of .....	504
STRENGTH, Test of, of Shot .....	296	WROUGHT-IRON CANNON, Weakness of .....	78
SULPHUR .....	201		
Refining .....	202		
THE “TAMERLANE,” Armament of .....	32		
TANGENT FIRING .....	499		













